



OFFICE OF INSPECTOR GENERAL OF THE NEBRASKA CORRECTIONAL SYSTEM 2018/2019 ANNUAL REPORT

Abstract

An annual report regarding the Nebraska Department of Correctional Services and the Nebraska Division of Parole Supervision. The report is a summary of the year's activities of the Office of Inspector General along with numerous observations, findings, and recommendations.

Doug Koebernick
dkoebernick@leg.ne.gov

Contents

INTRODUCTION.....	5
HIGHLIGHTS OF THE REPORT.....	7
RIGHT TO THE POINT	9
Staffing	9
Overcrowding	13
Solutions?	14
OMBUDSMAN AND INSPECTOR GENERAL RELATIONSHIP	18
STAFFING	19
Recruitment	19
FTE History	19
Demotions.....	20
Retirement Data	20
Overtime Hours.....	20
Mandatory and Voluntary Overtime	29
Turnover	30
Vacancies.....	32
Health Services Staffing.....	34
NDCS Recruitment and Retention Efforts	35
Diversity of Work Force	38
Tuition Assistance Expenditures for Staff	39
Other Ideas.....	40
New Normal	40
NSP AND TSCI UPDATES	41
September 2019 NSP Lockdown.....	45
STAFF SURVEYS	49
INMATE POPULATION	50
Incarceration Rates.....	53
Crime Rates in Nebraska.....	55
Correctional System Overcrowding Emergency Act.....	57
Population Goal.....	59
FACILITIES	60
New Construction.....	60
Existing Facilities.....	60

Future Projects	61
Right-sizing	61
ASSAULTS AND CAMERA COVERAGE	62
RESTRICTIVE HOUSING	63
NDCS Restrictive Housing Report	63
Legislatively Created External Restrictive Housing Work Group	63
Vera Report	64
Restrictive Housing Population	65
Close Management Units and Mission Specific Housing’s Impact on Restrictive Housing	65
Double Bunking	67
Placements	69
The Role of Intelligence	70
Peer Support Pilot Program	70
The Challenge Program	70
Modified Operations	71
Blue Rooms	71
Programming Needs	71
Serious Mental Illness	71
Direct Releases from Restrictive Housing	72
TSCI SMU Issues	72
Colorado	72
Summary	74
CONTRABAND	76
Contraband Tracking	76
Contraband Continues	76
Other Solutions?	77
DEATHS AT NDCS	78
Suicides	78
2016 Suicide Follow-up	78
Suicide Work Group Efforts	79
VOCATIONAL/EDUCATION	80
UPDATE ON ASSESSMENT TOOLS	82
Classification Tool	82
STRONG-R	83

ESCAPE UPDATES	85
McCook Work Ethic Camp Escapes	85
Community Corrections Escapes.....	85
PROGRAMS	86
Data.....	87
Areas of Concern.....	87
Substance Abuse Program.....	87
Staffing	88
Clubs/Social Groups/Non-NDCS Programs	88
COMMUNITY CORRECTIONS	89
Expansion.....	89
Other Community Custody Options/Innovative Ideas	89
Re-Entry Services.....	90
COUNTY JAIL PROGRAM.....	91
NDCS continues to c	91
INMATE LETTERS.....	92
ISDP (Inmates Sentenced to the Death Penalty) CONCERNS	93
NDCS STRATEGIC PLANS.....	94
NDCS RESEARCH DIVISION.....	97
CENTRAL OFFICE WORK ENVIRONMENT	99
DIVISION OF PAROLE SUPERVISION	100
Summary	100
RECOMMENDATIONS.....	102
Status of Past NDCS Recommendations	103
OIG RESOURCES AND GOALS.....	104
CONCLUSION	105

INTRODUCTION

This is the fourth annual report of the Office of Inspector General of the Nebraska Correctional System (OIG). The OIG was established in 2015 by the Nebraska Legislature in order to provide for increased accountability and oversight of the Nebraska correctional and parole systems. It was based on a recommendation of the Department of Correctional Services Special Investigative Committee, which was established by the adoption of Legislative Resolution 424 during the 2014 legislative session. The OIG identifies and examines systemic issues of the Nebraska Department of Correctional Services (NDCS) and the Division of Parole Supervision (Parole) and also investigates incidents resulting in death or serious injury that occur within the Nebraska correctional system. The OIG is affiliated with the Legislature's Office of Public Counsel, commonly known as the Ombudsman's office.

The Office of Inspector General of the Nebraska Correctional System Act is found in **Neb. Rev. Stat. § 47-901 – 47-919**. On September 16, 2015, Doug Koebernick was appointed as the first Inspector General of Corrections. In March 2017 Mr. Koebernick attended the Inspector General Institute sponsored by the Association of Inspectors General. He was awarded the designation of Certified Inspector General after completing the program. He attended the Association's conference in October 2018 and will be attending the Association's conference in September 2019 in order to continue his certification.

The OIG generates an annual report with its findings and recommendations to the members of the Judiciary Committee, the Clerk of the Legislature and the Governor by September 15th of each year. **Neb. Rev. Stat. § 47-918** requires this annual report:

On or before September 15 of each year, the Inspector General shall provide to each member of the Judiciary Committee of the Legislature, the Governor, and the Clerk of the Legislature a summary of reports and investigations made under the Office of Inspector General of the Nebraska Correctional System Act for the preceding year. The summary provided to the Clerk of the Legislature shall be provided electronically. The summaries shall include recommendations and an update on the status of recommendations made in prior summaries, if any. The recommendations may address issues discovered through investigations, audits, inspections, and reviews by the office that will (1) increase accountability and legislative oversight of the Nebraska correctional system, (2) improve operations of the department and the Nebraska correctional system, (3) deter and identify fraud, abuse, and illegal acts, and (4) identify inconsistencies between statutory requirements and requirements for accreditation. The summaries shall not contain any confidential or identifying information concerning the subjects of the reports and investigations.

The OIG has spent considerable time the past year visiting facilities, attending meetings related to correctional issues, visiting with senators and legislative staff, visiting with the residents and staff of the ten correctional facilities in order to gain a better understanding of correctional facilities and related programs, and reaching out to members of the community.

Nebraska law (**Neb. Rev. Stat. § 47-902**) charges the OIG with “*assisting in improving operations of NDCS and the Nebraska correctional system.*” The OIG is fully committed to that

responsibility and this report provides information related to those efforts. There will be many attachments to this report that will hopefully provide additional information for the reader and be useful to them in whatever role they play in the justice system in Nebraska.

The OIG would like to thank the inmates, parolees, staff and administration of NDCS and Parole, the Ombudsman's office and other community members who assisted with the OIG's efforts and shared their opinions, insights and suggestions during the past year. The OIG works continually with the staff of NDCS to understand the correctional system and their partnership in this effort is greatly appreciated.

This year's report will be slightly different than past reports in that it will be more streamlined and will make many references to past reports. As the OIG has become more accessible and known, the workload has continued to increase while the resources available to the OIG have remained the same. This has impacted the ability of the OIG to spend as much time on this report as compared to past reports. The attempt to streamline the report is not intended to diminish what is found in the report or what is actually reported but is intended to build on issues raised in past reports.

HIGHLIGHTS OF THE REPORT

During the past year, the OIG has communicated on a regular basis with not only the Nebraska Department of Correctional Services (NDCS), the Division of Parole Supervision (Parole), and the Board of Parole, but also with the Legislature's Judiciary Committee. The OIG examined many parts of the correctional and parole systems during the past year and the results of that work are contained in this report. As in past reports, the correctional system is the focus of the majority of this report.

Highlights of the report include:

- The two issues still confronting NDCS are understaffing and overcrowding (starts on page 9);
- Solutions to those two problems are not easy and a cooperative effort among the branches of government may be needed to address them (pages 16-17);
- NDCS had 533 individuals start their Pre-Service Training in FY 17/18, which is less than the past three years (page 19);
- NDCS had 55 staff voluntarily demote in the last fiscal year (page 20);
- NDCS overtime hours have continued to increase (pages 20-22);
- All but one facility continues to see a growth in overtime hours (pages 23-27);
- NDCS total overtime expenditures were over \$15 million in FY18 (pages 28-29);
- NDCS protective services positions experienced a slight decrease in turnover in 2018 (page 30);
- According to the Nebraska Department Administrative Services, the turnover rate for all NDCS employees dropped below 30% in 2018 (pages 31);
- NDCS vacancies hit all-time highs this year (page 33);
- The Division of Health Services has had fewer vacancies in behavioral health areas (page 34);
- NDCS has taken new action to attract and retain staff (pages 35);
- The number of minority employees in NDCS has increased to an all-time high (page 39);
- NSP and TSCI continue to face significant challenges, including a high number of inexperienced staff and a high number of vacancies (starting on page 42);
- Black inmates continue to be a disproportionate share of inmates in NSP's most difficult units (pages 42-43);
- A three day lockdown took place in September 2019 at NSP and the OIG received information that searches did not take place in some housing units (pages 45);
- NDCS population continues to grow (page 50);
- Nebraska has the lowest incarceration rate of its surrounding states but lags behind other states (pages 53-54);
- If the Overcrowding Emergency Act was enacted and carried out over 1100 inmates would have to be released to reach 125% of design capacity. There are less than 900 inmates past their parole eligibility date (pages 57-59);
- New construction has taken place and continues to take place in the correctional system (page 60);

- Restrictive housing has seen some changes but still holds nearly 350 individuals (starting on page 63);
- NDCS continues to double bunk individuals in a restrictive housing setting although they no longer do so in TSCI (page 67);
- The peer support program is succeeding at NSP and is being expanded to TSCI (page 70);
- “Blue Rooms” are being expanded throughout the system (page 71);
- The Violence Reduction Program has been expanded to restrictive housing (page 71);
- The OIG visited Colorado in April 2019 to learn about their restrictive housing practices (page 72-73);
- Contraband (drugs, cell phones, weapons) is a growing problem at some facilities (starting on page 76);
- Two suicides within NDCS facilities have taken place in 2019 (page 78);
- NDCS responded to the WEC escapes in 2018 by adding razor wire to the perimeter fencing and addressing a blind camera spot (page 85);
- Clinical and non-clinical programming continues to be expanded in NDCS (page 86);
- The OIG and the Ombudsman’s office has concerns about the inpatient sex offender program being moved from LCC to OCC in 2020 (pages 87);
- NDCS has over 600 offenders identified as needing domestic violence programming but does not offer it in any facilities (page 87);
- Community custody beds were increased in 2019, although female community custody beds were removed from Omaha (page 89);
- The OIG has opened over 160 cases with inmates this year and receives a number of letters each week, including a legislative proposal from the NSP Lifers’ Group (page 92);
- The OIG met with half of the death row inmates to learn about their concerns about their current housing situation (page 93);
- NDCS has issued several strategic plans and plan updates since 2015 (page 94);
- The Division of Parole Supervision has been independent of NDCS for three years and has implemented many new initiatives (page 100); and
- Recommendations made by the OIG begin on page 102.

Acronyms for NDCS Correctional Facilities

CCC-L = Community Corrections Center-Lincoln

CCC-O = Community Corrections Center-Omaha

DEC = Diagnostic and Evaluation Center

LCC = Lincoln Correctional Center

NCCW = Nebraska Correctional Center for Women

NCYF = Nebraska Correctional Youth Facility

NSP = Nebraska State Penitentiary

OCC = Omaha Correctional Center

TSCI = Tecumseh State Correctional Institute

WEC = Work Ethic Camp

RIGHT TO THE POINT

Two constants facing NDCS through the past four years have been the consistent challenges of overcrowding and understaffing. This report will cover a number of issues facing Nebraska's correctional and parole systems but the two that continue to rise above all the rest are those two issues. As a result, the report will start with those two issues, including a brief history of the issues and ways to possibly address the challenges. It will then continue with more in-depth exploration and data regarding those two issues, along with a number of other topics.

Staffing

In 2016, the OIG Annual Report found that NDCS was facing a staffing crisis. The report stated, "Should the current trends continue on overtime, vacancies, and departures, NDCS will only find itself in even more of a staffing crisis and may witness what took place at BSDC¹, only on a much larger scale."² Since 2016, the OIG has had countless conversations with NDCS staff and found that safety is a significant concern that impacts the ability to do their job. At the facilities facing the most significant staff shortages, staff have developed a continual sense of fatigue as their overtime hours impact their physical and mental well-being. Many do not see an end to this trend of working long hours in a stressful environment. They have also shared that in many instances they do not feel they are part of the decision making process, and that changes in policy are made without their input and sometimes with very little notice. As shared in past reports, a study by the Vera Institute of Justice in 2016 wrote the following regarding staff shortages:

Understaffing and frequent staff turnover at NDCS are likely due to a number of factors, including the location of some facilities far from population centers, a pay structure that is uncompetitive and does not reward longevity, and stressful and perilous work environments due to overcrowding and lack of resources. This results in an increased workload, even for newer, less experienced staff. It has also led to the frequent use of mandatory overtime, which correctional officers told Vera can negatively affect staff morale and lead to increased attrition. Employees become frustrated with overtime, which increases workplace stress and interferes with their personal lives, and often seek occupations with more set schedules elsewhere.

In addition to frustration from custody staff, Vera also heard that people hired as caseworkers were often surprised to find that their actual job duties were similar to custody staff, partly due to custody staff shortages. They reported dissatisfaction with their inability to run therapeutic programs, provide social services, and proactively engage people in programming and productive activities; instead, they spend much of their time escorting incarcerated people, managing counts, and responding to grievances. This likely contributes to high turnover of caseworkers as well, which negatively impacts facility functioning, staff morale, and institutional knowledge.

¹ BSDC is the Beatrice State Developmental Center. BSDC faced many difficulties about 10 years ago including a loss of federal funding and an investigation and oversight by the U.S. Department of Justice. Due to the deteriorating conditions at BSDC care for the residents diminished and resulted in serious injuries and deaths.

²

http://nebraskalegislature.gov/FloorDocs/104/PDF/Agencies/Inspector_General_of_the_Nebraska_Correctional_System/600_20160915-141014.pdf (page 21)

Incarcerated people also told Vera that they feel that correctional staff are treated poorly and that they wish case managers had more opportunities to facilitate programs and build rapport with the population...³

These past reports are still relevant.

NDCS Director Scott Frakes has shared his thoughts regarding staffing many times over the past four years, including in public testimony and in communications with NDCS staff. In 2015, Director Frakes distributed a letter that expressed his concern about his staff. He wrote:

Staff vacancies, heavy workloads, two years of negative media coverage, and excessive mandatory overtime are just some of the challenges we face...NDCS employees are tired, and it might be difficult to believe that things are going to get better. It is going to get better. I've asked the legislature and others to accept on blind faith that good changes will come to our Department. Now I'm asking you to do the same.⁴

He clearly understood the impact that staff shortages were having on those who report to him. A year later (August 2016) he shared the following with NDCS staff:

There are many reasons for our high turnover. Compensation is one of the reasons. You've told me that your greatest compensation concern (but not the only concern) is the lack of progression or performance pay. You don't understand why your training and experience doesn't result in higher compensation. I have said publicly that I agree with you, and this is where I will focus efforts to improve your compensation. There is a negotiations process, a budget process, and a funding allocation process. I will work hard to influence each of those.⁵

In August 2017 he wrote the following in an email to NDCS staff:

We have significantly high vacancies at TSCI and NSP and that contributes to being tired. We are requiring mandatory overtime at a pace that is not sustainable. I know we need more staff. What I also know is that we are hiring people. Even in this economy with a three percent unemployment rate, we are hiring people. We are also losing people at a steady rate. As they are leaving, a common reason given is "how they were treated."⁶

It wasn't until almost three years later that longevity pay (with the exception of TSCI employees) was implemented. Even now, different facilities are treated contrarily as far as pay which, at least anecdotally, has impacted staff morale at those facilities. In addition, two years after that was written overtime is even higher throughout the system and has continued to rise at what was thought to be unsustainable paces at specific facilities. Many staff are more fatigued. Hundreds of staff have left NDCS employment. As staff leave the level of experience then decreases as well which contributes to additional issues. This downward spiral has continued.

³ <http://www.corrections.nebraska.gov/pdf/Vera%20Institute%20Final%20Report%20to%20NDCS%2011-01-16%20v2.pdf>
(pages 18-19)

⁴ May 30, 2015 Letter by Director Scott Frakes to NDCS Staff

⁵ August 5, 2016 Frakes Files

⁶ August 4, 2017 Frakes Files

Shortly after Director Frakes sent that communication to staff in 2017, the following email was sent to staff by Erinn Criner, the Human Talent Director for NDCS, which stated:

Today, the Nebraska State Penitentiary and the Tecumseh State Correctional Institution are experiencing high vacancies, which results in more of our team members being required to work mandatory overtime.

We continue to actively recruit staff. The Omaha Correctional Center and Nebraska Correctional Youth Facility are providing 10 staff daily who will work in Tecumseh. Even with these staff members, we will still need additional volunteers for overtime to avoid mandatory overtime.⁷

Emails such requesting volunteers to work at stressed facilities are becoming much more common. In fact, now the OIG is being told of cases where staff report to their home facility and are being told that they will be working at NSP that day. When that email was written, ten staff were being sent to Tecumseh from Omaha on a daily basis. A new special detail was created that is based in Omaha and travels to Tecumseh. The special details now has 80 positions.

The 2016 OIG report also shared the results of a staff survey that was distributed to NDCS staff by the OIG in late 2015/early 2016. Over 600 NDCS employees responded to the non-scientific survey. The message was loud and clear. The staff believed starting wages needed to be increased to recruit individuals and that longevity pay needed to be reinstated to assist with the retention of staff. These were the two main proposals supported by the staff, although there were numerous other ideas as well. There was some slight movement on starting salaries for some positions but they still didn't match the starting salaries of staff in local county jails. Longevity pay was not acted upon until July 1, 2019. Among its many results, the survey found the following:

- 61.1 percent did not believe the starting salary for their position was appropriate;
- 45.2 percent did not look forward to coming to work on most days;
- 54.4 percent would not recommend a job at NDCS to a friend or family member;
- 55.4 percent felt they could approach a supervisor with a concern regarding their work environment;
- 68 percent said that salary advancement each year above the hiring wage would be the primary change that could take place to retain employees;
- 50.7 percent of respondents didn't know which direction NDCS was headed; and,
- 0.8 percent of respondents agreed that the Legislature supports the employees of NDCS.

In August 2016, an email with a Google survey was sent to every staff member in NDCS from the OIG. The survey included one question: "If you could make one change (or process improvement) to improve your work area, shift or facility within the Nebraska Department of Correctional Services, what would it be?" Within a few days nearly 300 responses were received by the OIG. Many of the responses focused on beginning pay and step pay. Other issues raised

⁷ August 17, 2017 NDCS Email from Erinn Criner

included enhancing communication between layers of NDCS, eliminating the “good old boy club,” ending the practice of retaliation, the impact of restrictive housing changes, the need to hire quality staff, and the overall need for resources throughout NDCS.

OIG staff surveys were distributed in 2017 and 2018 and the results were similar.

NDCS worked with the Nebraska Department of Administrative Services in late 2015 and 2016 and conducted a culture survey. More than 470 NDCS employees were interviewed and the survey found that there were perceptions of inequity and favoritism, wages were not satisfactory, morale was suffering, staff were dissatisfied with those in positions of leadership, and staff did not appreciate how they are perceived by the public. After the completion of the survey NDCS issued a release that was “aimed at addressing recruitment and retention challenges identified by agency staff in the NDCS Staff Culture Survey.” The four initiatives announced by NDCS were:

- Implementing a 12-hour Shift Pilot Program at TSCI;
- Establishing a 1st-Level Supervisors Pilot Program at the Nebraska State Penitentiary;
- Facility Security/Procedure Audits; and,
- Constructing a 100-bed temporary housing unit Community Corrections Center-Lincoln.

However, these four initiatives didn’t seem to get at the root of the problems that were shared by staff as part of the interview process. While these were likely positive steps taken by NDCS it is difficult to see how they actually related to the findings of the Culture Survey. The 12 hour shifts were a change that needed to be addressed with the state employees union and it wasn’t included in the union contract until the most recent one went into effect on July 1, 2019. The supervisor program at the Nebraska State Penitentiary was a good step but it only impacted a small number of individuals. It has since been expanded so that is a positive step. The Facility Security/Procedure Audits came about as a result of the escapes at the Lincoln Correctional Center and may have addressed some safety concerns that may have been a part of the Culture Survey. The construction of the temporary housing at CCC-L was an idea that was promoted by the OIG and the Nebraska Legislature and was not initially supported by NDCS. It was unclear how that was related to the Culture Survey other than indirect safety or overcrowding effects.

With that said, the Culture Survey was a notable effort by NDCS to understand the views of their staff and it provided the staff with another avenue for sharing their views. The results also mirrored the OIG survey results.

The OIG has been asked many times in recent months what the Department needs to do to address staffing problems. The difficulty with answering that question is that there is no easy answer. One reason for there not being an easy answer is that the problem was not adequately addressed in a timely manner. While there were some steps taken by NDCS to attempt to address the staffing problem (and these will be shared later) in 2016 through 2018, they didn’t get to the heart of the matter. The staff continued to share similar complaints and requests during that time.

The OIG has shared the findings from the surveys and from other OIG efforts and made several recommendations over the past three years. These recommendations included establishing a

work group on staff retention, establishing a tiered pay system, rewarding staff who take on extra duties, meeting with Nebraska's community colleges to discuss the development of career tracks and other classes or training programs that would help recruit, develop and grow the NDCS workforce, establishing longevity pay plans, and several others.

It is not like nothing has been done to attempt to address the staff shortage issue. During the 2016 legislative session, Senator Dan Watermeier introduced Legislative Bill 733 to provide \$2.5 million to NDCS to assist with staffing. It was written broadly in order to provide NDCS with discretion on how to utilize the funds. NDCS testified in a neutral position on the bill because they weren't sure what they would use the funds for and, as a result, the Legislature scaled it back to \$1.5 million. These funds were utilized in a number of ways, including \$500 retention bonuses, commuting bonuses for TSCI staff, developing wellness centers, and various training and development programs. Reports detailing the use of the funds were reported to the Legislature.⁸ Since then other steps have been taken by NDCS. Some of these efforts include twice implementing hiring bonuses, developing a pilot project at TSCI to reward longevity⁹, launching a process improvement process, utilizing employee councils, and increasing salaries for approximately 1200 staff. This past year contract negotiations resulted in increases in pay, including the establishment of some type of longevity/merit pay plan at some facilities. In addition, the Legislature demonstrated a willingness to offer assistance to NDCS during the 2015 to 2019 legislative sessions.

It is also important to note that this issue didn't just start in the past four or five years. In fact, there is a reason to believe that the neglect of the state correctional system for the 10-15 years prior to that time contributed to this problem.¹⁰ In the 2016 OIG report, the following was shared:

During the past year, the OIG has had numerous conversations with past and current employees of NDCS. In many cases, they describe a "starving" agency that has not been able to ask for the resources it needed during prior administrations because of political pressure from above to not spend any additional money. They described the changes in the agency that resulted from it not having the resources needed to fulfill its mission.

Additional information on what led up to this situation will be shared later in this section.

Overcrowding

As will be shown later in the report, overcrowding of the prison system has been a continual problem. On October 19, 2018 Director Frakes appeared before the LR 127 Special Committee and said:

Capacity is another priority area. Our population continues to hover around 5300 people. We have all been anticipating the effects of LB 605 and have not seen the population reduction that was predicted. Projections calculated prior to the Justice

⁸ Specific information on those initiatives can be found at https://nebraskalegislature.gov/FloorDocs/105/PDF/Agencies/Correctional_Services_Department_of/595_20170905-171026.pdf

⁹ But as NSP saw a significant increase in vacancies requests to expand the TSCI pilot program to NSP were dismissed.

¹⁰ There are some veteran correctional watchers who believe it goes back even further than 10-15 years.

Reinvestment Initiative (JRI) would have put us at an average daily population of 5433. Had we not undertaken the JRI work, the population would be higher.

Today, the population of the state correctional system is over 5550 inmates. It is projected to keep growing based on past models. NDCS has contracted with a company to develop new population projections and those should be completed soon according to the terms of the contract with the company.

There is a perception that Nebraska likely incarcerates individuals at a higher rate than other states due to the overcrowded conditions in the correctional system. However, the 2018 OIG Annual Report shared that Nebraska actually had the 14th lowest incarceration rate in the nation in 2016 (283 people incarcerated per 100,000 residents). It should be noted that within incarceration rate data there are differences when comparing the incarceration rates of different races of people. Nebraska has the 11th highest racial disparity when comparing incarceration rates of black and white individuals. In Nebraska, a black individual is incarcerated at a rate 8.7 times higher than a white individual. Nebraska has the 28th highest racial disparity when comparing incarceration rates of Hispanic and white individuals. In Nebraska, a Hispanic individual is incarcerated at a rate 1.2 times higher than a white individual.

In the last 40 years prison and jail incarceration rates have continually grown. According to the Prison Policy Initiative, Nebraska's incarceration rate was under 100 people incarcerated per 100,000 residents in 1978. Along with this, Nebraska crime rates generally decreased between 2000 and 2017 except for some increase in the last few years, especially in violent crime.

There is also a perception by some that overcrowding of the correctional system is a new occurrence. It was explained in last year's report that it is not. However, an excerpt from a news story when Tecumseh was selected as the site of a new correctional facility in 1998 explains the situation at that time and gives additional perspective:

The Legislature in 1997 authorized the new prison to ease prison overcrowding. At that time, the state prison system had 1,100 more prisoners than it had room for. By the time the prison is operational in the year 2001, Corrections official Steve King said the state will have 1,700 more prisoners than beds. "The day the thing opens, we'll fill it and still be overcrowded," King said.¹¹

As will be discussed later, the system has an additional 484 beds funded and it will be important to understand whether or not those beds will actually positively impact the current rate of overcrowding conditions when they are completed.

Solutions?

Everyone wants to know what the solutions are to these problems. The exercise above that laid out a lot of the issues related to these two problems shows that there are no easy answers and that numerous attempts to resolve them have not succeeded. These attempts should not be dismissed since Nebraska would likely be in a much worse situation if these efforts had not taken place.

¹¹ https://www.theindependent.com/news/tecumseh-wins-prison/article_305baec9-e39f-54cd-abf1-74734c749ecb.html

Previously, it was stated that these issues were not the result of actions just within the past few years but were part of a longer period of neglect prior to 2015. The LR 424 Report in 2014 began a period of additional attention being paid to the correctional system. There are undoubtedly some in NDCS and in the public who do not appreciate the work of that committee or the light that was shined on the actions of NDCS. However, it is likely without that light being shone, the problems within NDCS would have become worse and ignored for a longer period of time. The Legislature would have likely continued to be unaware of the decline of the system and the executive branch may have not felt any pressure to take action. This scrutiny has borne fruit in the form of additional pay for staff, increases in inmate programming, a greater awareness of the challenges of restrictive housing, the need to look at sentencing reforms, the need for accountability and oversight over the correctional and parole systems, and an understanding of the negative impacts of overcrowding and understaffing. The LR 424 Report shared how the leadership of NDCS, which was then led by Director Robert Houston, was aware of the decline of the system and that there were definite needs that were not being met on a day to day basis. There is no evidence that he shared these dire circumstances with the legislative branch but there is ample evidence that this was shared with the executive branch. The following excerpt from the LR 424 Report explains this best:

In the fall of 2009 through 2010, there was activity by the Department of Correctional Services to prepare a proposal to present to the Governor for additional capital construction based upon the 2006 Carter Goble Lee report. Like all of the previous attempts, this discussion concerning the need for capital construction to address capacity issues did not culminate in an appropriation request by the Governor's office. Nor did the Department of Correctional Services or the Governor ever advocate for resources to build additional capacity.

Finally, on March 14, 2012, a meeting between Bob Houston and Governor Heineman took place that addressed prison capacity and, once again, updated figures on building the additional capacity recommended in the 2006 Carter Goble Lee report. Director Houston prepared an outline for the meeting which included the obvious, but important observation: "NDCS must reduce its population or increase its capacity." The outline proposed three different options for the Governor's consideration. The options were labeled "No Cost Options", "Low Cost Options", and "Build Capacity". The "Build Capacity" option presented the Governor with the updated cost figures on adding 1,300 beds to the capacity of NDCS. This "Build Capacity" option involved capital construction proposed in the 2006 Master Plan by Carter Goble Lee. The "No Cost Options" were a variety of strategies intended to move inmates out of the Department of Correctional Services institutions in a shorter time span. The "Low Cost Options" involved minimal expenditures and Band-Aid approaches to deal with overcrowding.

In his testimony before the Committee, Governor Heineman acknowledged that all three options were presented and he elected to go with the "No Cost Options." "In reality, the administration had already begun implementing many of the "No Cost Options." It is important, nevertheless, to recognize that a deliberate decision was made by the administration to not build additional capacity and, instead, pursue "No Cost Options."

It is the implementation of the various “No Cost Options” that became the subject of the various scandals investigated by this Committee.

At no time did the administration propose building more capacity. No appropriation request was ever made to the legislature by the Department of Correctional Services nor the Governor’s office. What’s more, the Director insisted in meetings with Senators that the numbers were manageable. Clearly that was not the case. In short, the decision to not follow the recommendations of the Carter Goble Lee report was the Governor’s alone and it follows that the resulting overcrowding and its related consequences were of his own making.

As will be evident in the sections that follow, overcrowding began to drive the administration at NDCS, like a principle of physics NDCS could not escape.¹²

If action had been taken back then, Nebraska would likely be in much better shape as far as overcrowding. It definitely can be argued that this would have then positively impacted staffing as overcrowding has a negative impact on staff within the system. The same can be said for the lack of action to significantly impact recruitment and retention of staff prior to 2019. As explained above, the needs of the system were known. Director Frakes shared repeatedly that he knew what needed to be done and that he would advocate for those changes. It took until 2019 to make significant changes on longevity pay but there is still a need to do something different to impact recruitment, which applies to many positions within NDCS including medical positions, behavioral health positions, recreation positions, security positions and others. There is need for high quality individuals to enter these fields and enhance Nebraska’s correctional system.

The problem has now reached a point where it appears that Nebraska may have hit its’ limit, at least right now, on the number of quality individuals that can be recruited for these positions, especially the security positions. If true, especially as Nebraska constructs a 100 bed minimum custody unit at NSP and a 384 high security unit at LCC, the question arises regarding whether or not the new staff needed for those positions will be available. Francis Bacon once said, “Hope is a good breakfast, but it is a bad supper.” Nebraska can hope that the staffing situation will resolve itself in the next year or two but definite action needs to be taken to make it so or else these new units will be short-handed from the first day of operation.

The OIG would strongly recommend that the Governor, the Legislature and NDCS work together and create a comprehensive task force that will conduct a strenuous in-depth examination of the staffing problems facing NDCS. The task force should include individuals that represent a variety of interests, including NDCS security staff, other NDCS shortage areas, community colleges, human resources, former NDCS staffers, formerly incarcerated individuals, the Department of Labor, policy makers, representatives from Gallup and others. The task force should give itself a short deadline so that policy makers can utilize what they learn to move forward as soon as possible. One idea that they could consider would be the development of a long-term plan to professionalize the NDCS workforce. Examples of this can be found in other countries such as Germany in which officers are treated as professionals and receive comprehensive training for two years. It is a position that is considered desirable and competition

¹² https://nebraskalegislature.gov/pdf/reports/committee/select_special/lr424_2014/lr424_report.pdf (page 37)

exists in obtaining the position.¹³ In the short-term consideration should be given to changing the salary structure for new staff and a related impact on longer serving staff, especially in shortage areas. The task force could also review the working conditions in settings across the system. They would be able to move quickly due to the previous efforts of the OIG, NDCS and outside consultants.

As far as overcrowding, there are options available: build more beds, reduce the influx of new prisoners, establish innovative alternative programs¹⁴, reduce or divert the return of formerly incarcerated individuals, commute lengthy or life sentences, and increase reentry success rates. Again, figuring out the short-term and long-term pathways for success in addressing overcrowding will need to be done in a collaborative manner by the legislative and executive branches of government, as well as the judiciary branch. Action must take place that will result in substantive changes and plans should be made that all players will commit to carrying out. Paul Feilmann may have a point.¹⁵ It may be necessary to have a group look at both of these issues since they are so interconnected. It would be beneficial to have someone with the skill set of former Senator Kermit Brashear leading the way on this effort.

The answers aren't easy. If they were, they would have taken place by now. Many times the OIG is asked if it is too late to address these problems. The answer is that even though the clock is ticking Nebraska doesn't have a choice. Nebraska has to address these problems, for the safety of our incarcerated individuals, for the safety of our NDCS staff, for the safety of the public, and for the long-term benefit of our citizens and communities.

Now, onto the rest of the report.

¹³ <https://www.correctionsone.com/correctional-healthcare/articles/what-can-us-corrections-learn-from-the-german-prison-system-Hgvc02nL77KqAjhG/>

¹⁴ For example, a pre-parole system in which incarcerated individuals are placed in community beds in their home communities where they receive programming and transitional preparation services.

¹⁵ https://www.omaha.com/news/social-issues/omaha-man-says-he-ll-maintain-vigil-until-gov-pete/article_ffba059a-35fd-5f79-a44b-7397d3e57a2f.html

OMBUDSMAN AND INSPECTOR GENERAL RELATIONSHIP

As shared in the 2018 report, the relationship between the Ombudsman's office and the OIG has evolved since the creation of the OIG. There has been confusion from some regarding the roles of the two offices. The Inspector General for Corrections was hired by the Ombudsman, and reports to the Ombudsman and to two senators, the Chair of the Judiciary Committee and the Chair of the Executive Board.

The OIG was established by the Nebraska Legislature in order to provide for increased accountability and oversight of the Nebraska correctional system. The main responsibilities of the OIG are to identify and examine **systemic** issues of the Nebraska Department of Correctional Services, and to also investigate incidents resulting in death or serious injury that occur within the Nebraska correctional system.

The Ombudsman's Office is an independent complaint-handling office within the Nebraska Legislature for the use of citizens who have complaints about the actions of all administrative agencies of state government, that is, the bureaucracy of state government. In regards to correctional issues, the Office has staff who focus on **individual** complaints which can come from inmates, correctional staff and members of the public.

The OIG and the Ombudsman's office communicate constantly in order to share their respective experiences regarding correctional and parole issues. In some ways, it is a partnership in which both offices assist the other in understanding any trends, issues or concerns in those systems. They make every attempt to not duplicate their efforts. At times, their efforts may overlap, but this ends up being a positive factor for each office, as they share information and grow their respective oversight capacities through collaboration.

In the 2018 report, there were examples of how this relationship had worked. Those examples would still apply in 2019.

STAFFING

Past OIG reports found that “NDCS is in a staffing crisis” and each report reported a number of statistics related to staffing throughout the system and at each facility. This report will provide updated data in each of those areas.

Recruitment

The 2016 OIG report found that during fiscal year (FY) 2013-14, 462 individuals started their pre-service training program for NDCS. This peaked in FY2017-18 at 661 individuals but decreased during the most recent fiscal year. Of the 533 individuals who started training in the recent fiscal year 478 individuals finished it and 345 of those individuals were protective services staff.

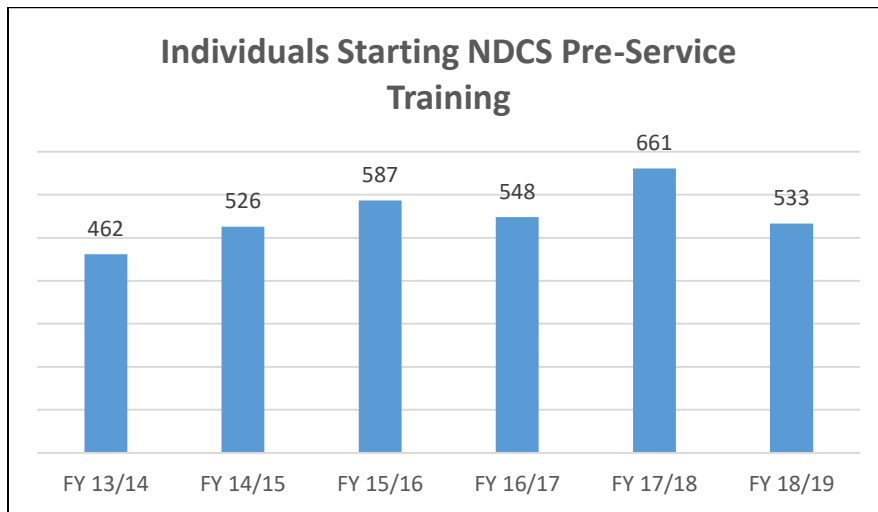

FIGURE 1

FTE History

During the past ten years, the number of full-time employees utilized by NDCS has actually decreased.

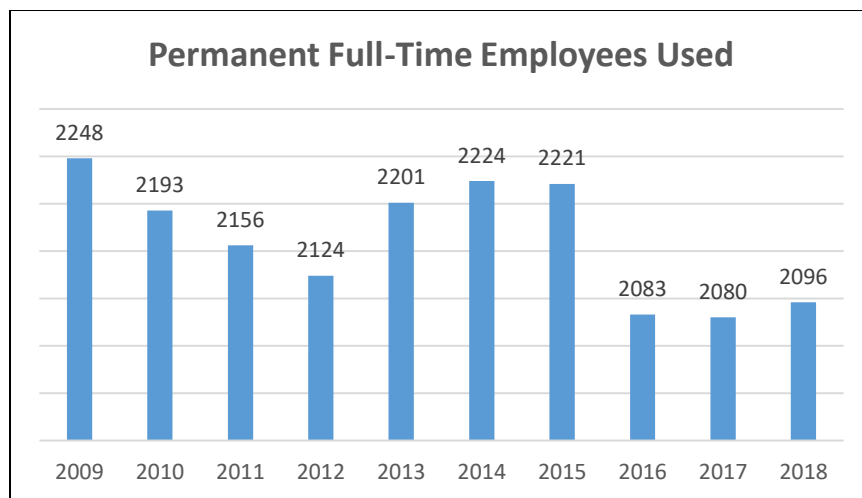

FIGURE 2: SOURCE 2019 DAS PERSONNEL ALMANAC

Demotions

A recent issue presented to the OIG by staff was the number of individuals who received or requested demotions within NDCS. Demotions could be the result of discipline, a desire to move to a different facility, a wish to try a new area within NDCS or a number of other reasons. Some staff have demoted from a salary position to a non-salary position so that they can receive overtime pay and possibly have more control over their work schedule. This is an area that the OIG will begin to more closely monitor. NDCS provided data regarding this for FY18-19 and it will be tracked in future reports.

	All staff	Protective Services Staff
Disciplinary Demotion	6	4
Voluntary Demotion	55	35

TABLE 1

Retirement Data

According to the 2019 DAS Personnel Almanac there were 415 NDCS employees eligible for retirement on December 31, 2018. This was 20% of the NDCS workforce at that time. Of these individuals, 192 were between the ages of 55-59, 165 were between the ages of 60-64, and 58 were 65 years old or older. This is actually a lower percentage than other large state agencies, as the Department of Health and Human Services had over 30% of their employees eligible for retirement, the Department of Transportation had over 40% of their employees eligible for retirement and the total for retirement eligible employees for all state agencies was approximately 32%.¹⁶

Overtime Hours

In past reports, the overtime data that has been reported has covered protective services employees. Protective service employees are defined by NDCS as the positions of correctional officer, corporal and caseworker. Previous reports found that the average amount of overtime throughout NDCS steadily grew for these employees. Figure 3 shows the changes in overtime hours worked by those staff going back to 2014. During that period overtime hours worked has continued to increase as demonstrated by the trend line in the chart.¹⁷

¹⁶ 2019 DAS Personnel Almanac, page 145

¹⁷ There is a significant spike in overtime rates during the summer of 2015. This took place as a result of the TSCI riot in 2015.

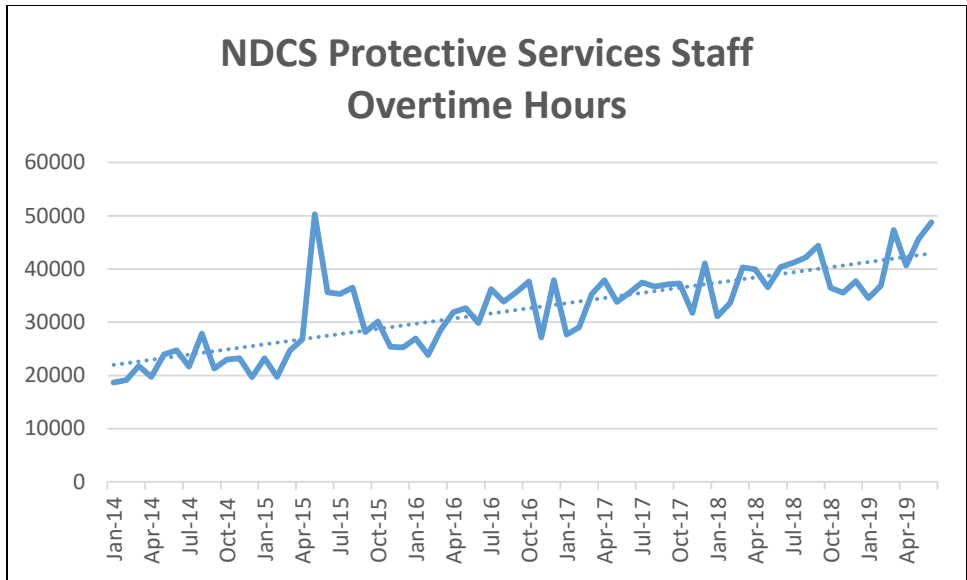

FIGURE 3

Another way to review the overtime data is to compare it from year to year. The next chart compares 2017, 2018 and 2019. So far every month in 2019 is higher than the same months in the previous two years.

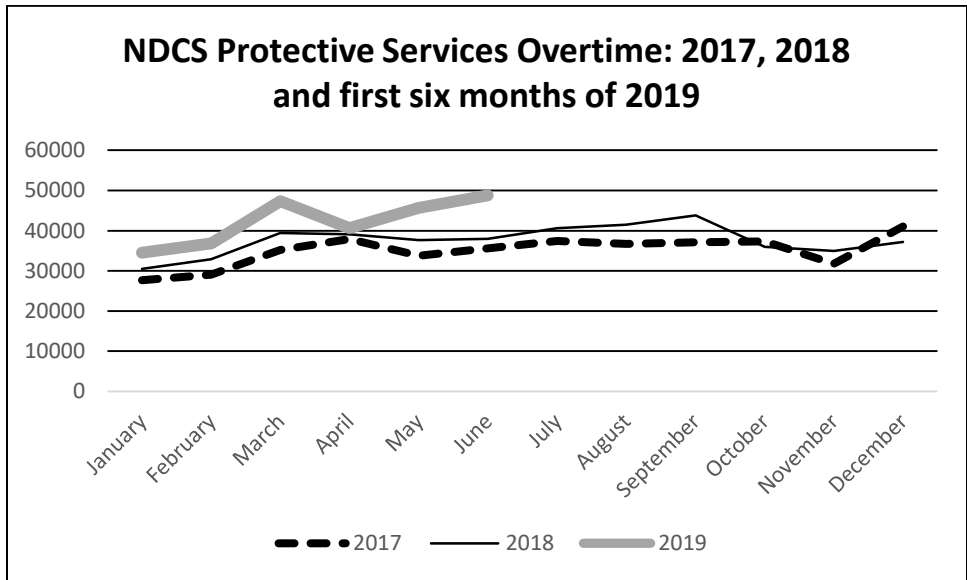

FIGURE 4

A third way to break down this data is to look at the average overtime hours for all protective services staff by month in those three years. The next chart, as the data above would indicate, shows an increase during this time period, including a 21% increase from 2017 to 2019.

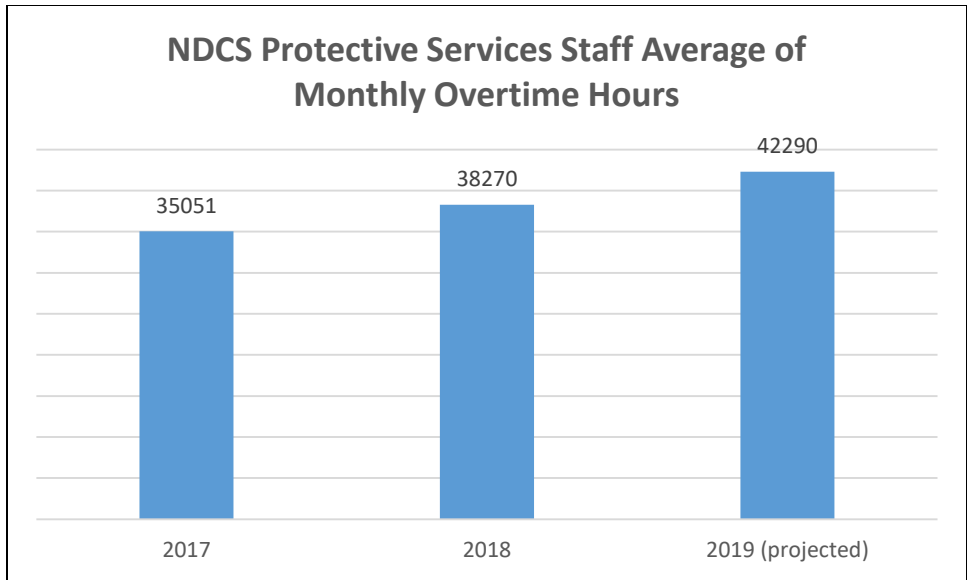

FIGURE 5

The OIG began tracking total overtime for all NDCS employees in 2018. This number has grown significantly as well. It is likely that this has increased due to staff that are not protective services staff stepping up and assisting the understaffed facilities which need more staff positions filled. In January 2018 there were 6836 hours of overtime by non-protective services staff. This had increased to 10774 hours in June 2019. As a result, the overall overtime by non-protective services staff has grown by 57% during that time.

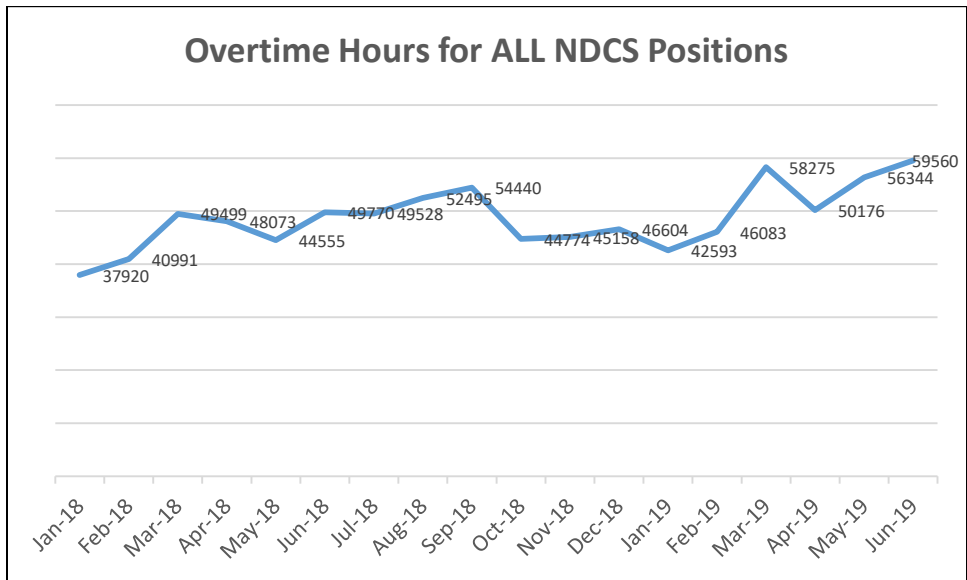

FIGURE 6

Each of the ten facilities has their own unique overtime data. The following charts show changes in overtime usage by protective services staff at each of the ten facilities. There are several factors that influence the amount of overtime used that are not a part of these charts, including

the total number of protective services staff and that if an individual regularly works at Facility A and works overtime at Facility B the overtime actually is shown up as being used at Facility A.

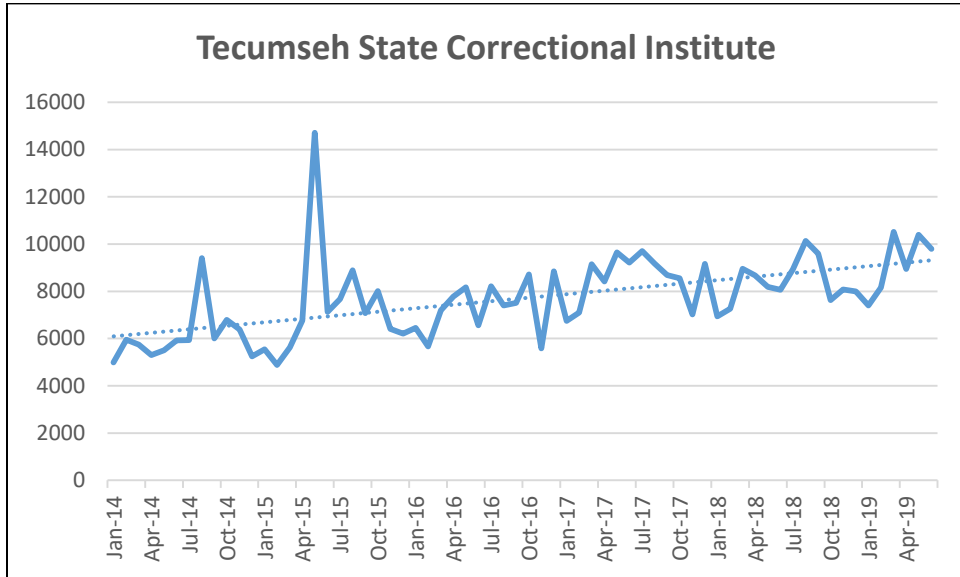

FIGURE 7

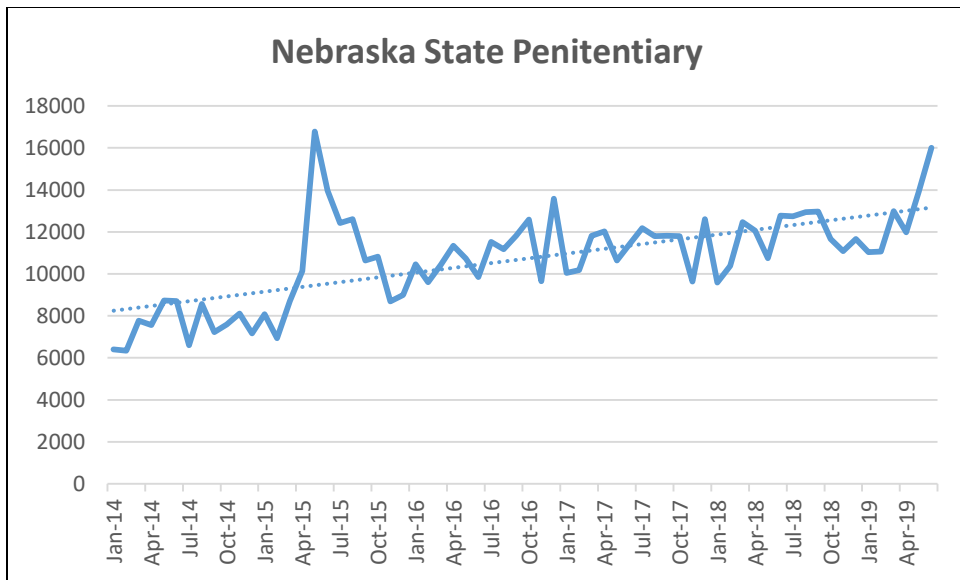

FIGURE 8

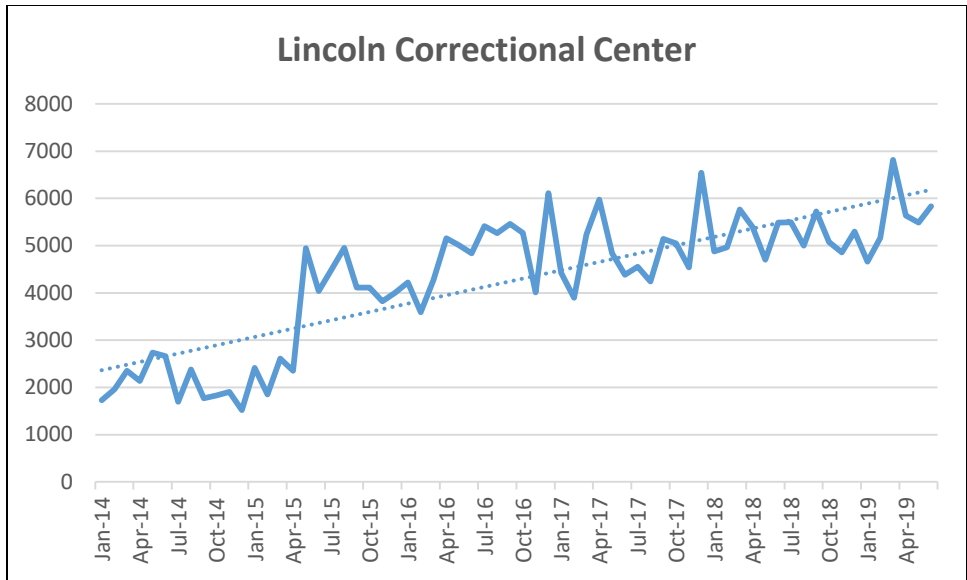

FIGURE 9

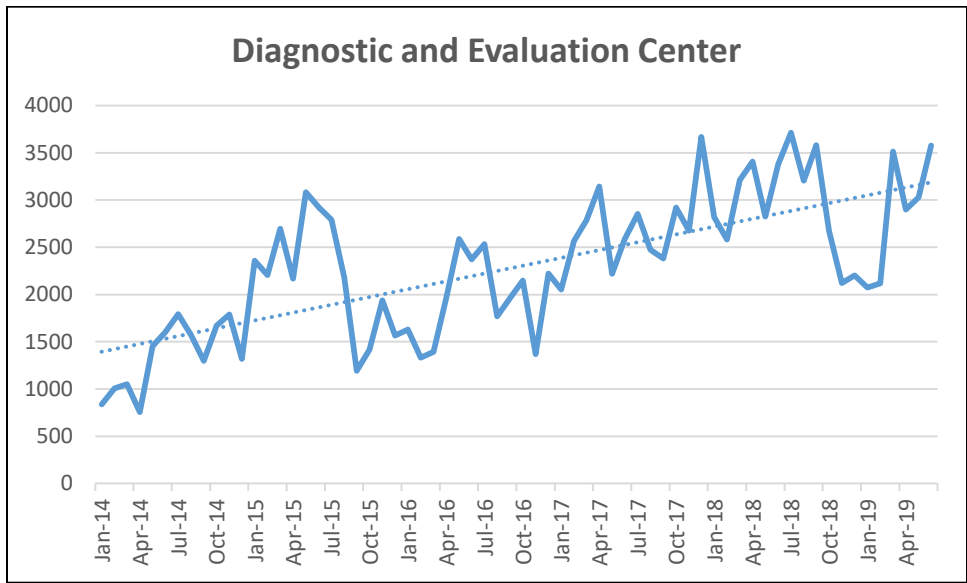

FIGURE 10

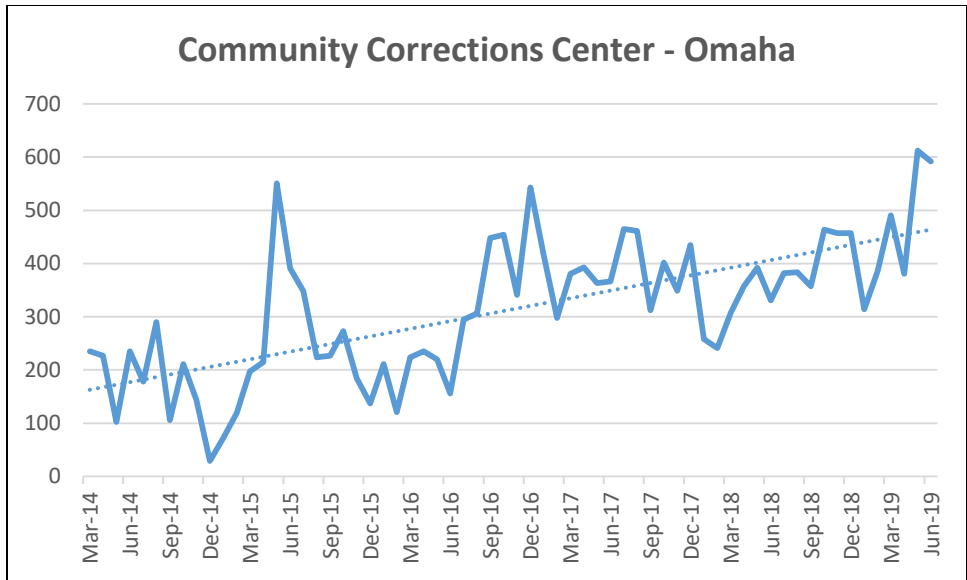

FIGURE 11

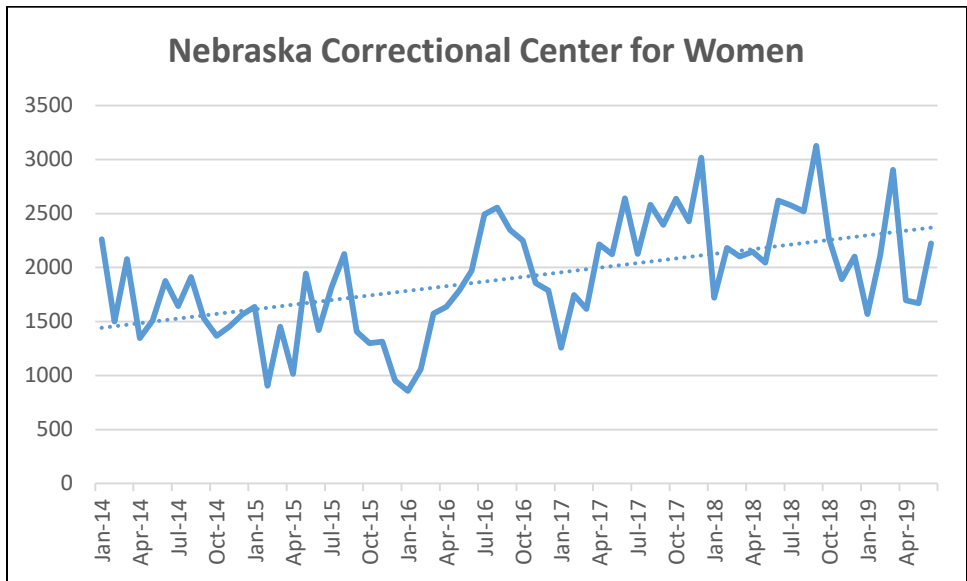

FIGURE 12

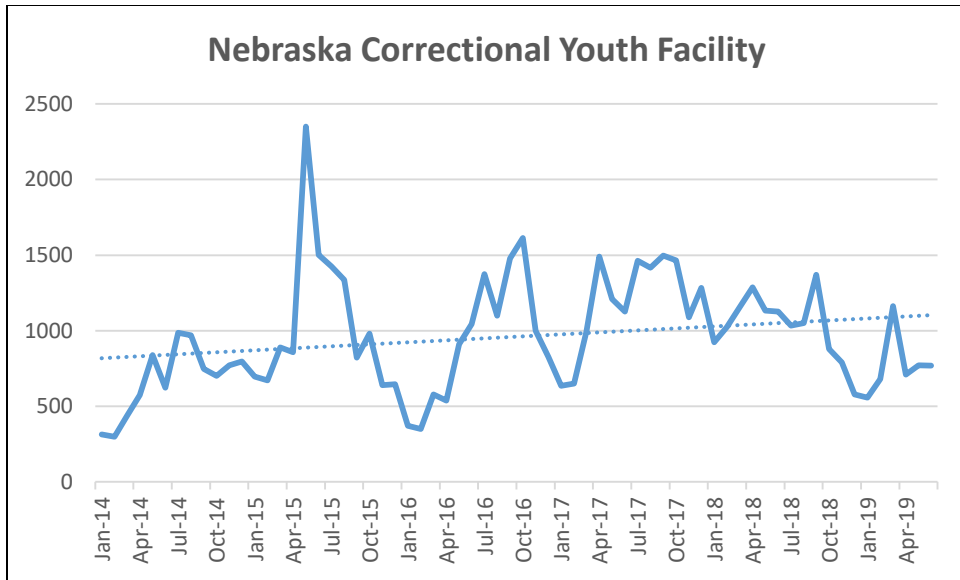

FIGURE 13

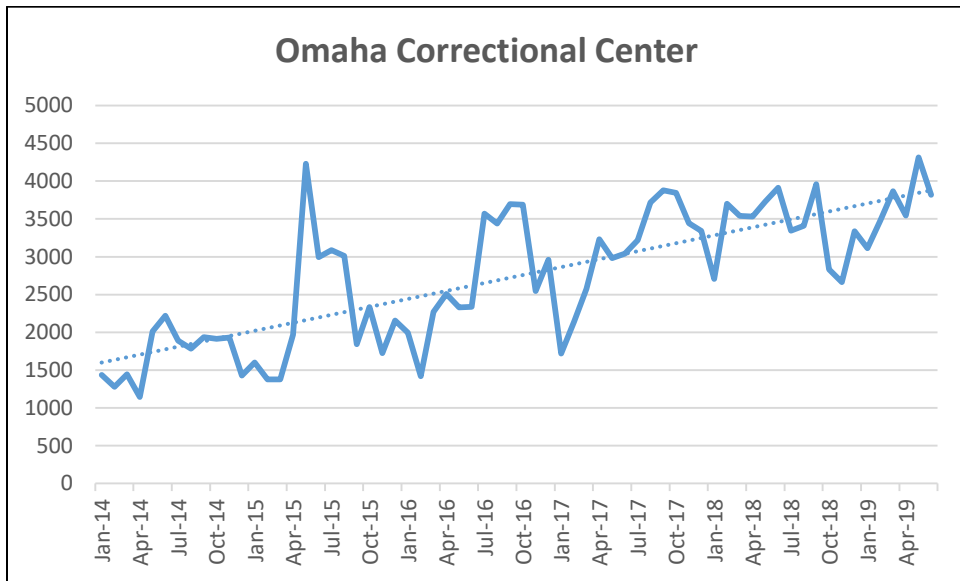

FIGURE 14

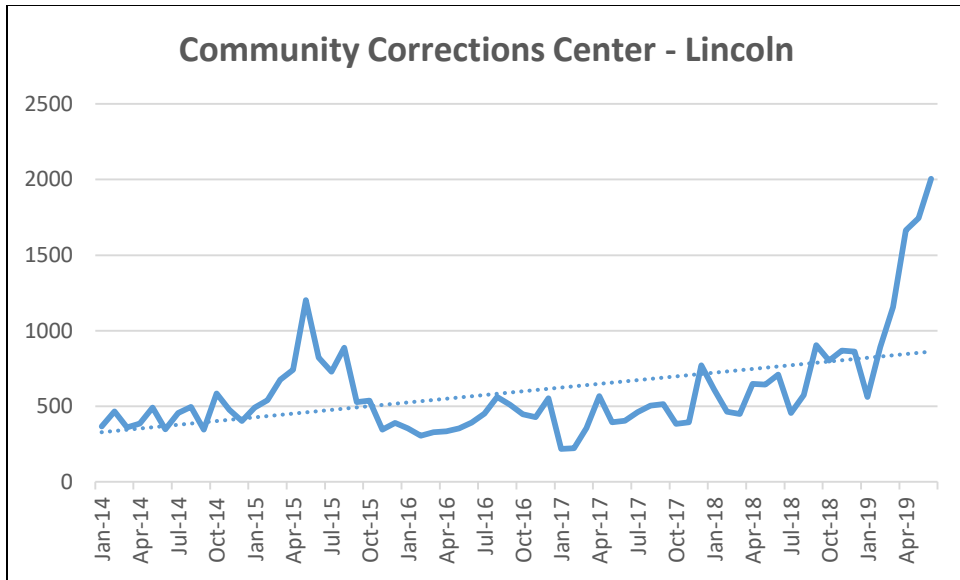

FIGURE 15

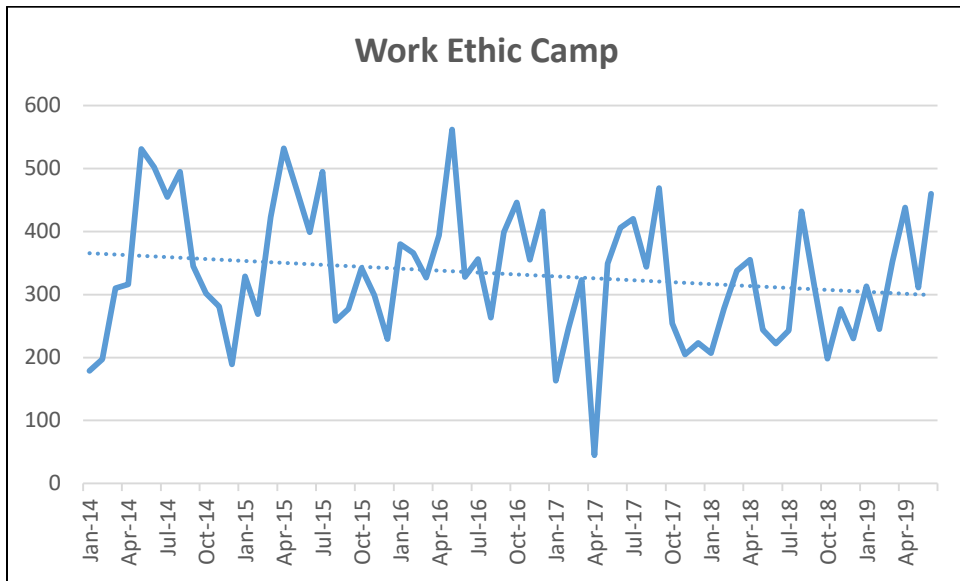

FIGURE 16

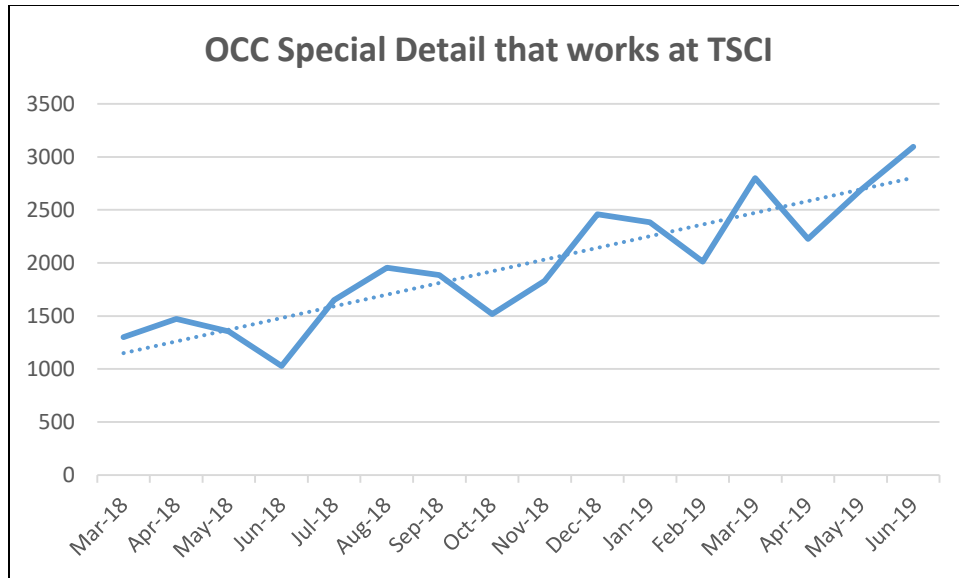

FIGURE 17

Out of the ten correctional facilities and the OCC Special Detail (that works at TSCI) only one (the Work Ethic Camp) has a trend line that is decreasing.

The amount of money spent on overtime for NDCS staff has increased dramatically. Overtime costs for all NDCS employees has almost tripled between FY2006-07 and FY2017-18, increasing from \$5.3 million in FY2006-07 to over \$15 million in FY2017-18, according to the 2019 Department of Administrative Services Personnel Almanac (Figure 18). In that same fiscal year, the Department of Health and Human Services had the second highest expenditures for overtime at \$6.35 million.

Straight time overtime takes place when an employee who is paid a salary and not eligible for overtime works extra hours at a facility. Instead of receiving their extra pay at a rate of 150% of their hourly wage they are paid their current hourly wage. Data from NDCS shows that over 5,000 hours of straight time overtime was paid out during FY2017-18 (Figure 19).

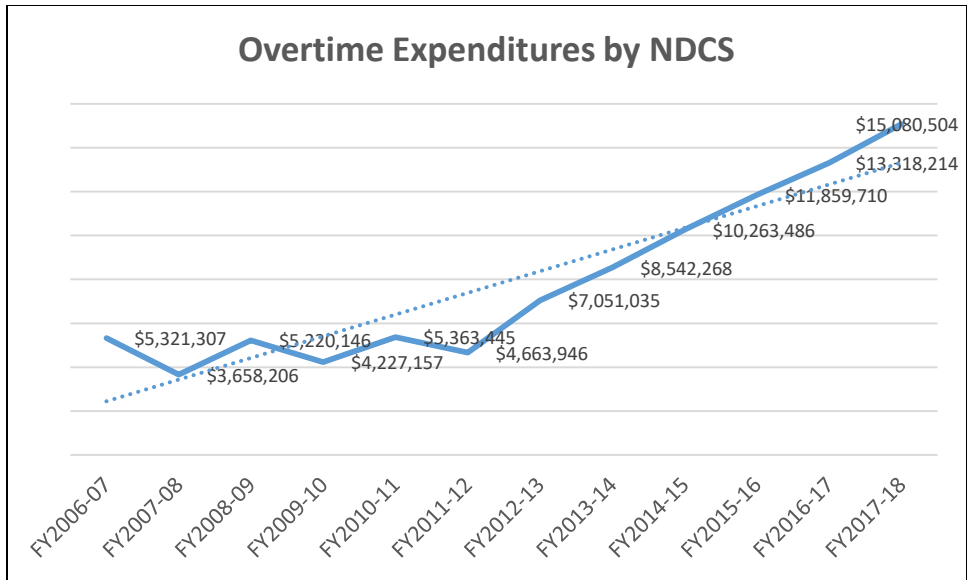

FIGURE 18: SOURCE 2019 DAS PERSONNEL ALMANAC

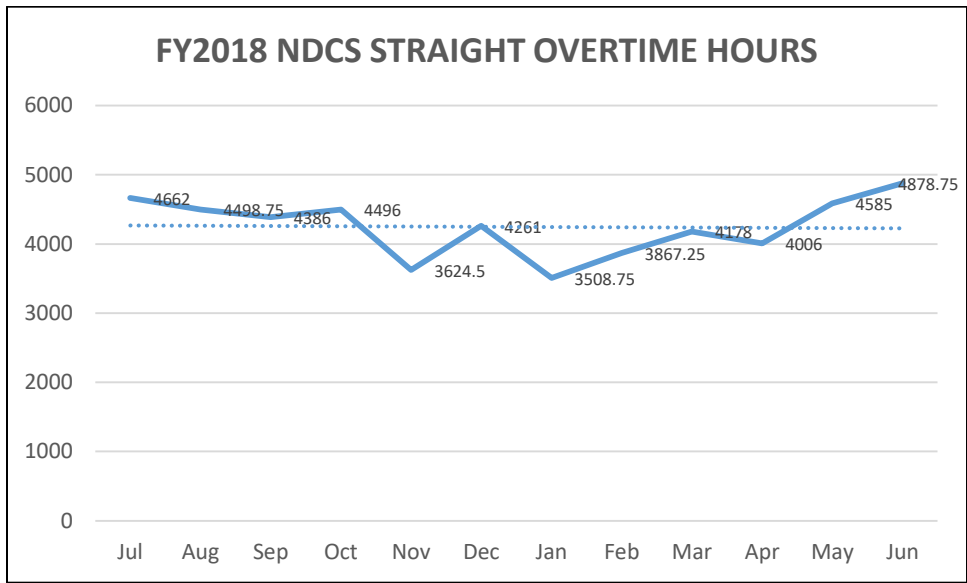

FIGURE 19

Mandatory and Voluntary Overtime

As shared in past reports, when staff work overtime hours they can either do so in a mandatory or voluntary manner. The simple difference is that mandatory overtime occurs when employees are required by NDCS to work extra hours that they were not scheduled to work, and where they do not typically have a choice in working those hours. Voluntary overtime hours are those worked by an employee as a result of their independent decision to do so. The view on mandatory and voluntary overtime is that there is a real difference, but at some facilities it is difficult to differentiate between the two categories. At facilities such as TSCI or NSP many individuals choose to work voluntary overtime in an effort to keep from receiving mandatory overtime. They also choose to work voluntary overtime due to their desire to assist their fellow employee who does not have the support around them that they likely desire. Employees may

also work voluntary overtime hours in the hope that someone will do the same when there is not the appropriate staffing levels and they need to avoid working overtime. As a result, the OIG decided in the past to only track total overtime hours for NDCS.¹⁸ The bottom line is that even though mandatory overtime may be going down in some instances that does not necessarily mean that this is a positive change in the correctional system.

Turnover

Turnover of protective services employees significantly increased from 2010 to 2017 but has decreased in 2018 and appears to be decreasing in 2019. Total agency positions are also predicted to turn over less in 2019 as well, based on projections made by the OIG.

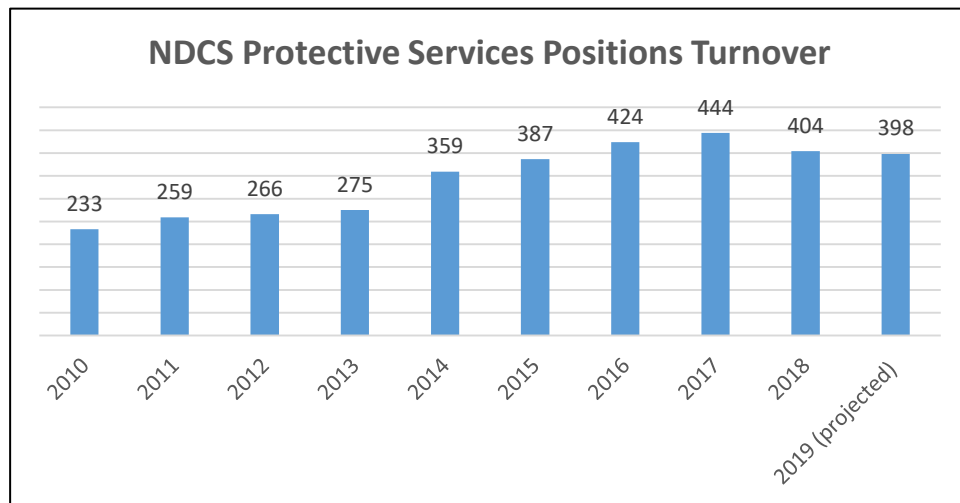

FIGURE 20

The 2019 DAS State Personnel Almanac is consistent with this data by showing a slight decrease in the total turnover rate for NDCS, although it is still higher than the rate from 2007 to 2015.

¹⁸ In addition, due to the way the system is constructed the number of mandatory overtime hours and voluntary overtime hours did not match the total overtime hours provided to the OIG.

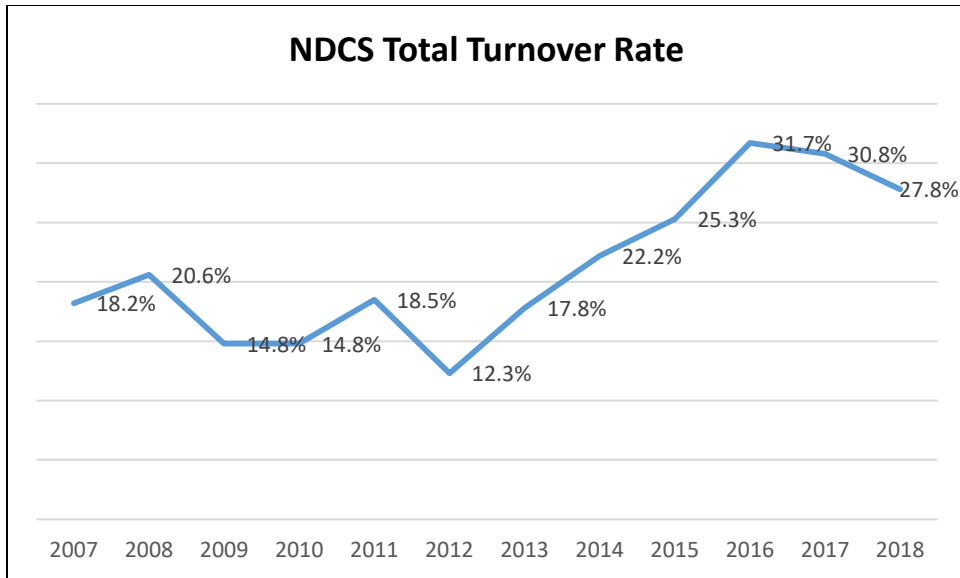

FIGURE 21: SOURCE 2019 DAS PERSONNEL ALMANAC

The 2019 State Personnel Almanac also reported that in 2018 NDCS had four positions that had higher turnover rates than 15%. In 2017, there were six positions that had turnover rates higher than 15% but Corrections Lieutenant and Corrections Unit Case Manager experienced a decrease in the turnover rate. Both of these positions had experienced a significant increase from 2016 to 2017 (Lieutenant increased from 2% to 23% and Unit Case Manager had increased from 14% to 22%).

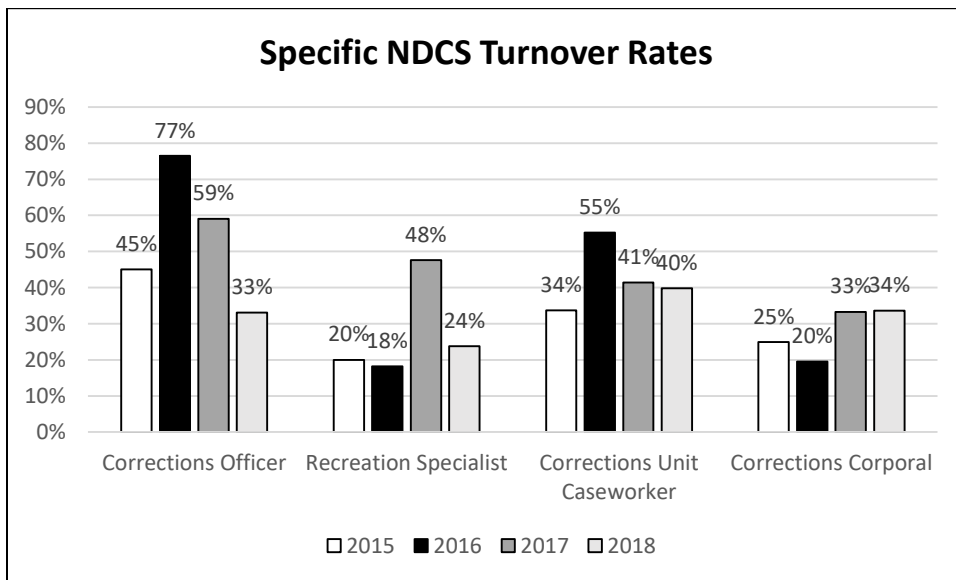

FIGURE 22: SOURCE 2019 DAS PERSONNEL ALMANAC

There are potentially multiple reasons for these decreases in turnover rates. As far as the significant decrease in the turnover rate for Corrections Officers, NDCS is now hiring many more individuals as Corporals instead of the entry level position of Corrections Officer. In addition, if positions are vacant then no one is in that position and able to turnover. While

turnover rates are important to look at the OIG can make the case that overtime and vacancies are more relevant pieces of data.

In the 2018 OIG Annual Report, the OIG shared that NDCS and the Nebraska Department of Administrative Services (DAS) calculated turnover rates in two different manners. NDCS bases their turnover rate on the number of authorized FTEs for NDCS. DAS bases their turnover rates on the number of people actually employed by an agency on December 31st of each year. As a result, DAS’ data results in higher turnover rates than those reported by NDCS.¹⁹ The OIG contacted NDCS about this difference and was told that both methods were acceptable and that it was important to have consistency and transparency. The OIG recommended in 2018 that NDCS change the way that they measure turnover so that it is measured like the rest of the state agencies but this recommendation was rejected by NDCS. The reason behind this recommendation that was shared in last year’s report was that it was based on a review of how many agencies or businesses track turnover rates, that using this measurement would also make the comparison between Nebraska’s turnover rate for state correctional positions and other state’s turnover rates for state correctional positions more of an “apples to apples” comparison.

Vacancies

As stated in past reports, vacancy data for protective services staff is somewhat more difficult to track due to changes in the way NDCS defines the actual number of vacancies. For this year’s report, the total number of vacancies as reported to the OIG by NDCS on June 30, 2019 are contained in the two charts below.

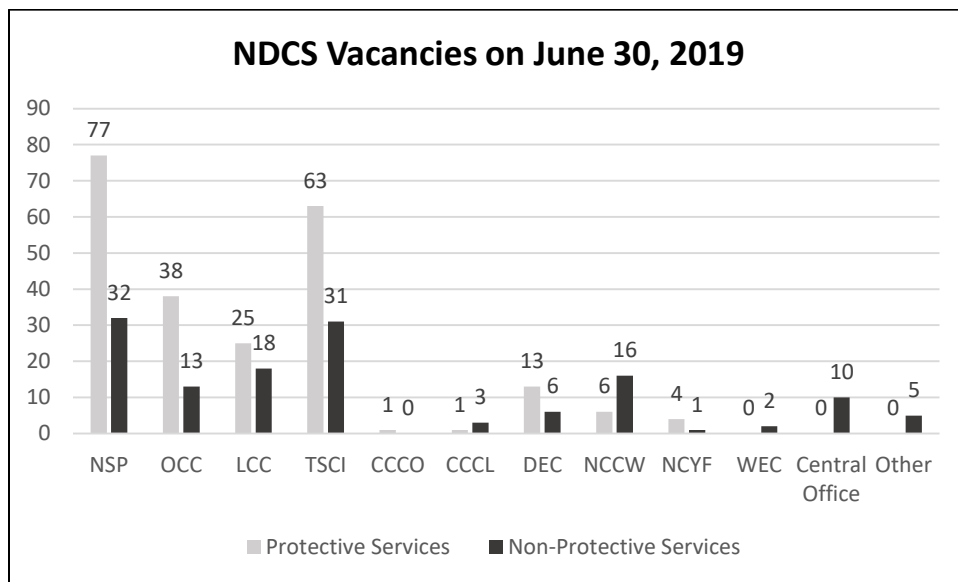

FIGURE 23

As mentioned previously, staff are being hired in Omaha to work at TSCI. These staff are compensated for their driving time and are not required to accept mandatory overtime. Since they are compensated for their driving time, they are essentially paid for three hours of driving and five hours of working if they are working an eight hour shift. TSCI has shifted 80 positions

¹⁹ This due to there always being a higher number of authorized FTEs that positions actually filled.

to the special detail. However, since they are only working five out of eight hours these 80 positions are essentially conducting the work of 50 employees. As a result there are 30 vacancies at TSCI that are unaccounted for in the data. NDCS should begin to account for this in their vacancy data so that an accurate and complete vacancy picture is provided to policy makers.

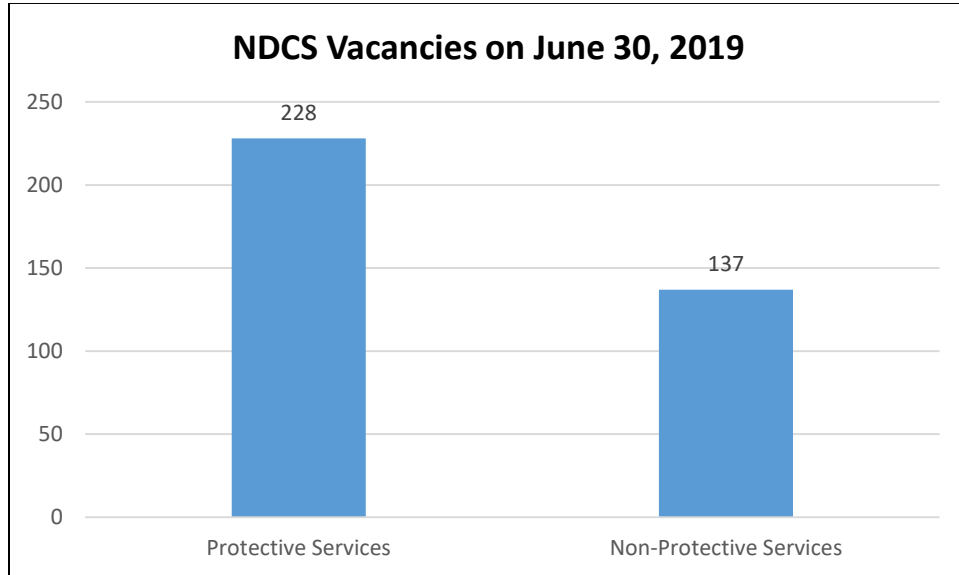

FIGURE 24

The State of Nebraska also compiles and publishes a quarterly State of Nebraska Vacancy Report. The latest version of this report is dated June 30, 2019. This report shows every current vacancy, the date the vacancy took place and salary information for that position. The number of total NDCS vacancies, according to these reports, has increased during the past year.

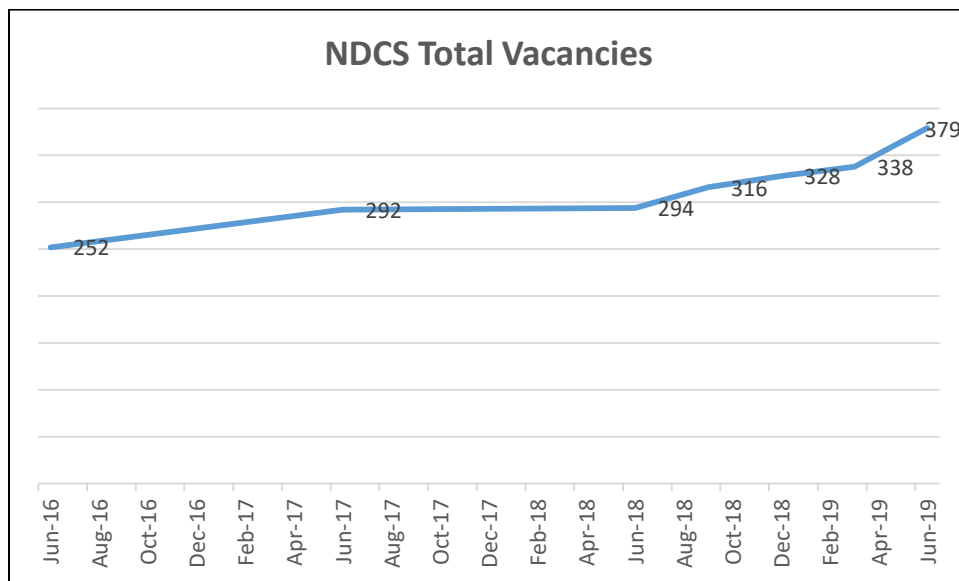

FIGURE 25: SOURCE STATE OF NEBRASKA VACANCY REPORTS

As shared in the 2019 OIG Annual Report, state law requires NDCS to conduct a full staffing analysis no later than 2020. This will provide critical information on whether there are other categories that need additional staff positions. These categories could be in such areas as administrative support, medical, recreation, maintenance and even higher ranked security and case management positions.

Health Services Staffing

As reported in the 2019 OIG Annual Report, NDCS had 29 Behavioral Health clinical vacancies in July 2018 (Figure 26).

NDCS Behavioral Health Clinical Vacancies ⁸								
	DEC	LCC	NCW	NSP	OCC	TSC	WEC	Total
Certified Master Social Worker				1	1			2
Chemical Dependency Counselor	1	1	1	2	2	1	1	9
Chemical Dependency Counselor Supervisor					1			1
Clinical Program Manager		1			1			2
Director of Social Work				1				1
Mental Health Practitioner II		2	2	1	3	1		9
Mental Health Practitioner Supervisor					1			1
Psychologist			1		1	2		4
Total	1	4	4	5	10	4	1	29

FIGURE 26

The most recent data shows an improvement in this area as the total vacancies in those areas were 21 vacancies in June 2019.

Staffing

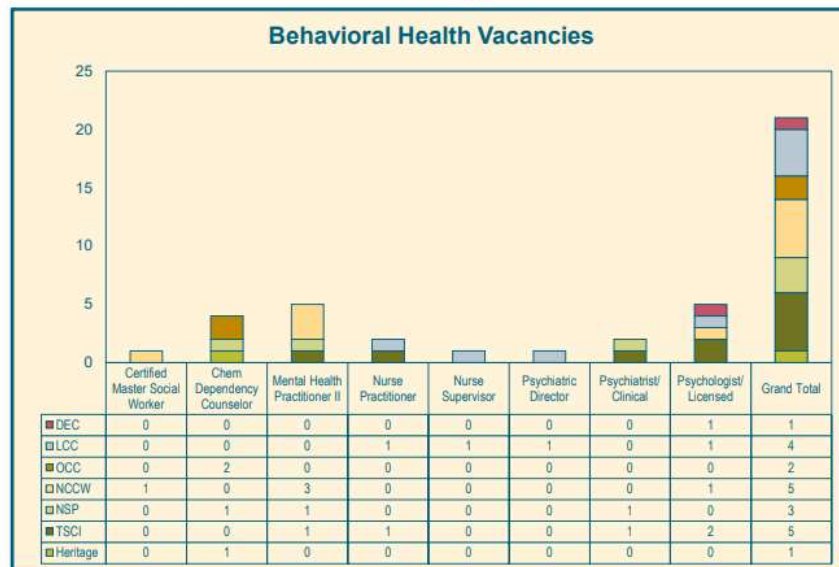

Calendar Year-to-Date Turnover (April-June 2019)

FIGURE 27

NDCS Recruitment and Retention Efforts

Since 2016 NDCS has attempted a variety of initiatives to impact the recruitment and retention of staff, including long-term efforts, bonuses, longevity raises, and transporting employees from one location to another.

As shared in last year's report, the OIG met with three leaders of NDCS in order to learn more about their efforts to recruit and retain staff. The following long-term efforts being made by NDCS were shared during that meeting:

- Leadership Academy for Supervisors: NDCS has established a new training program for supervisors;
- SMART Goals: Action steps taken to transform NDCS goals into reality. This is a program initiated in several state agencies in 2018;
- Daily Huddles: NDCS has thirty active huddles consisting of individuals who have been trained in Lean Six Sigma;²⁰
- Employee Positive Impact Council (EPIC): Each facility holds regular meetings of their EPIC group that focus on issues such as communication, employee engagement and improving interactions with the incarcerated individuals in their facility; and
- Process Improvements: NDCS is part of a state agency initiative that is focused on improving performance by removing waste, reducing variation and working as a team. Each NDCS employee is required to complete a one-hour online class related to this initiative.

NDCS has also continued their employee recruitment efforts through advertisements, career fairs, visiting high schools and recruitment efforts in other settings.

On October 2, 2017, Director Frakes announced two plans that were focused on TSCI and NSP. The first initiative was aimed at recruitment and provided a \$2500 bonus for the first 100 employees hired at those two facilities. The second initiative was aimed at retention and provided a merit/longevity pay increase for all employees at TSCI. Under this initiative, the incentive ranged from increases in pay of 2.5% to 10% depending on the years of experience for the employees. The press release announcing these initiatives stated the following regarding the Department's plans on how to pay for these endeavors:

The costs for these initiatives will be managed, in large part, through overtime cost avoidance. For example, every vacancy the agency fills (and doesn't have to staff with overtime), saves \$13,000/year. Over the course of a year, staffing essential posts with overtime at TSCI costs nearly \$1,000,000 more per year than if the vacant positions were filled with full time employees. Process improvement efforts are reducing costs and providing the ability to reallocate funds to these initiatives.²¹

It is not clear how NDCS funded these initiatives since overtime did not increase at either facility.

²⁰ Documents with greater detail regarding these three programs can be found in the OIG 2018 Annual Report

²¹ NDCS Press Release, October 2, 2017

On November 17, 2017 Director Frakes shared this statement regarding the recruitment retention:

The hiring bonus has been well received,” Director Frakes said. “As we give more future team members the opportunity to take advantage of this benefit, we hope to continue to decrease the vacancies and reduce the need for mandatory overtime at NSP and TSCI.”²²

NDCS eventually filled 96 of the 100 positions that were eligible for the \$2500 bonus. 71% of those staff (68 staff) were still employed on June 25, 2018. As of August 23, 2019, less than two years later, only 33% of those staff (32 of the 96) were still employed by the Department. In addition, vacancies and overtime increased at both facilities.

On April 22, 2019 NDCS announced several other efforts to address recruitment and retention.

First, \$3,000 bonuses would be provided to the first 100 new employees who stay at least a year at one of the four prisons that they indicated had the most significant staffing problems: TSCI, NSP, LCC and DEC. The positions that could receive a bonus included protective services staff as well as caseworkers, counselors, nurses and other medical providers. At the end of June less than 50 employees had been hired who would be eligible for the bonus. As of September 9, 2019 NDCS is still advertising using the \$3000 bonus.

Second, current NDCS employees would receive bonuses ranging from \$50 to \$400 if they recruit a new staff member. A new referral program was announced on July 31, 2019 by NDCS that will provide for a \$3000 bonus to current NDCS employees who successfully refer a new employee hired as a corporal at TSCI or NSP. This will continue until 100 corporals are hired at those two facilities. Under this proposal the current employee will receive \$500 when the corporal finishes the Staff Training Academy, \$1000 when the corporal finishes their probationary period, and \$1500 when the corporal completes their first year of employment.

Third, supervisors would qualify for bonuses of up to \$400 if a worker they supervise remains with the department at least a year. In addition, new labor contracts that started on July 1, 2019 provided for various longevity and merit pay increases for correctional staff.

In addition, the new contracts with NAPE and the Fraternal Order of Police (the two unions representing NDCS union staff) were implemented on July 1, 2019. The employees working under the NAPE contract received a 2% pay raise on July 1, 2019. If they had a satisfactory performance rating they then received an additional 0.3% pay raise. This will be the same on July 1, 2020. Some NAPE employees at TSCI, NSP, LCC and DEC received longevity bonuses that range from a 2.5% increase for one year of service to a 10% increase for ten years of service. This is not part of the union contract. The pay raises were similar for those under the Fraternal Order of Police (FOP) contract except that all FOP members received the longevity raises given to select NAPE members unless the individual did not have a positive performance evaluation.²³

²² NDCS Press Release, November 17, 2017

²³ Approximately 40 FOP members did not qualify for the additional raises due to their performance evaluations not meeting the correct standard.

One other initiative that was started by NDCS to assist staffing levels at TSCI and NSP was the hiring of individuals at OCC but assigning them to work at those two facilities. It started with 10-15 staff and they were split between the two facilities. Eventually all of the staff were shifted to TSCI. Currently there are approximately 70 staff (and ten vacancies) who are transported from Omaha to TSCI each day. They are paid for the three hours of travel time and work five hours at TSCI. The immediate impact is that this has provided some relief to the staff at TSCI.

Finally, NDCS undertook two other efforts this past year related to staffing. A project was undertaken in order to gain a better understanding of issues related to staff retention. A team was put together by Director Frakes to lead this project. This follows up a past OIG recommendation that stated: “Convene a work group on staff retention that includes people in positions throughout NDCS and individuals from outside NDCS.” Earlier this year, it updated the OIG on past recommendations and shared this regarding that recommendation:

Retention work group report shared. Project provided information consistent with other information collecting efforts over the years. Current initiatives to address compensation and leadership skills consistent with areas identified as being the greatest need.

Last fall, when the OIG learned that the work group was going to be formed Director Frakes was contacted and asked for more details about the effort. Director Frakes asked the OIG for input on the group and substantial input was provided by the OIG. As the work group moved forward with its work the OIG asked for a list of the members and information on their efforts. This request was denied and after inquiring again with Director Frakes in July 2019 the report from the group was released a few days later. The report of the work group provided information from a survey that they conducted with 469 NDCS staff. Among the conclusions in the report were that wages for some health staff are below market rates and that wage compression between represented staff and supervisors is an emerging issue.²⁴ The staff who worked on this effort worked together to develop the questions and to conduct the surveys with the help of other key staff. They reviewed the results and presented a thoughtful and comprehensive report to Director Frakes.

NDCS also contracted with Gallup, with support from a private donor, to begin an employee engagement exercise. 1524 NDCS staff responded to a survey from Gallup that had 12 questions that measure the most important elements of employee engagement.²⁵ It established a baseline for future surveys and also provides supervisors with additional tools for increasing employee engagement. Information on this effort was shared with the OIG in a special briefing led by the NDCS Director of Human Resources. This is a promising exercise but NDCS needs to utilize it in the months and years ahead to gain benefits from the exercise.

Wage compression is emerging as an area of concern as a result of the State of Nebraska providing additional pay and incentives to the unionized, non-salary staff. When this takes place, salaries for those staff start to catch up to supervisory salaries and when the non-salaried staff work overtime their pay increases. Meanwhile, the salaried staff may work more than 40 hours but are typically not compensated for that effort. In addition, NDCS needs to review the salary

²⁴ Attachment A: 2018 Retention Project

²⁵ <https://q12.gallup.com/public/en-us/Features>

structure of wardens, deputy wardens, other administrative positions and more to determine how those rates of pay compare with competitors. It is key that NDCS not only promote the best and the brightest but that they also are in a position to recruit the best and the brightest from outside the system. It is encouraging that two wardens were recruited from outside the NDCS system in recent years,²⁶ but the rates of pay for other positions should be reviewed so that they can recruit for those positions and also retain people in those positions, no matter if they were internal or external candidates. In 2015, the Director of NDCS was hired and his salary was 51% higher than the previous NDCS Director. At the time, the pay increase was supported by Governor Ricketts and explained in a news story regarding his hiring:

Ricketts said he saw no contradiction between his goal of limiting government and the steep increase in pay for the Department of Correctional Services director. He called Frakes' higher salary an "investment" in improving an agency plagued with problems. Those problems range from overcrowding to early releases of prisoners and a lack of programs to help inmates change in their lives. "We have to invest prudently and wisely to make sure we're doing a better job," Ricketts said. Getting someone who can chart a new course for state corrections should help Nebraska slow the growth of government, he said. It also should help boost public trust in government. "We're paying Director Frakes commensurate with his skills and his experience," Ricketts said. "Frakes has more than 32 years of experience in corrections, starting as a corrections officer and moving his way up. He comes from a system that has embraced prison reforms such as the reduced use of solitary confinement and increased community supervision."²⁷

The NDCS Director's salary is now nearly \$190,000. Comparable positions in Iowa and Kansas pay approximately \$140,000 and \$150,000 respectively. Harold Clarke, who leads the Virginia Department of Corrections, and has led state correctional agencies in Nebraska, Washington and Massachusetts is currently paid \$156,060. The difference in pay between Nebraska and other states could be used as an example when it comes to paying other salaried positions within NDCS so that high quality individuals with experience can fill these important positions.

Diversity of Work Force

The 2016 OIG report found that NDCS faced challenges regarding the diversity of their workforce and that 231 minority employees were employed by NDCS in 2014. This has increased in the years since and is currently at 315 minority employees, which is equal to 15.2% of its total employees. For some comparison the percentage of minority employees was only 9.3% in 2011 and was 12.8% in 2017. The number of NDCS minority employees has increased by over 36% increase since 2014 and NDCS should be commended for this improvement.

²⁶ Both from private prison systems

²⁷ https://www.omaha.com/news/nebraska/new-nebraska-corrections-director-frakes-getting-big-salary-bump-over/article_c837053e-0612-556a-8409-d94c55605af4.html

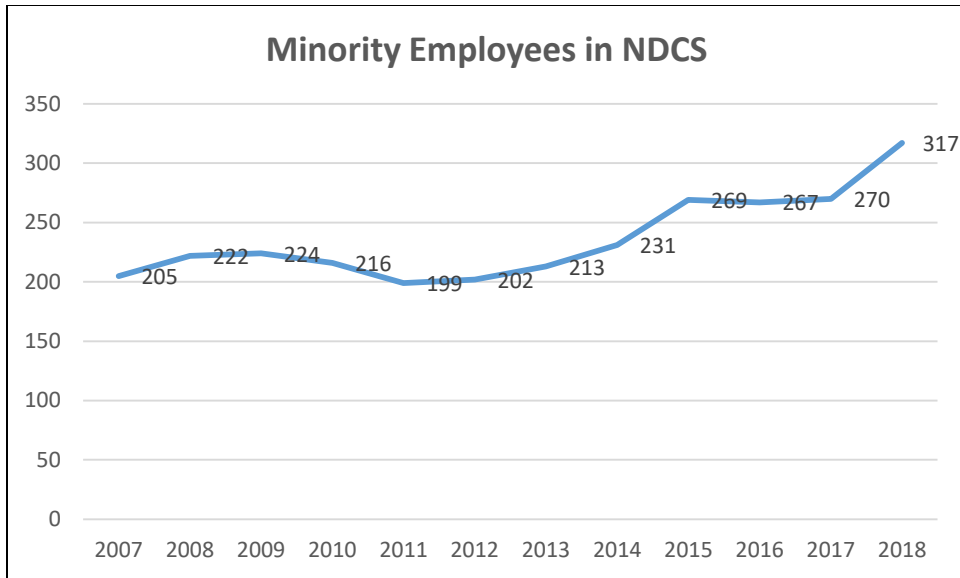

FIGURE 28: SOURCE 2019 DAS PERSONNEL ALMANAC

As stated in last year’s report, it is key that that NDCS continue to build upon their efforts to increase the recruitment and retention of minority staff, including staff who speak Spanish and other languages that are spoken by inmates in the NDCS facilities. One reason for the need for NDCS to increase recruitment and retention of minority staff is that this can result in building a pipeline that results in more minorities being promoted into leadership positions in NDCS. There are few minorities in leadership positions in NDCS.

Tuition Assistance Expenditures for Staff

One of the selling points that NDCS utilizes during employee recruitment is the ability of NDCS staff to utilize tuition assistance. For at least ten years NDCS has been the state agency that expends the most amount of funds on tuition assistance. While it is still the top agency in this regard (Transportation is second just head of Health and Human Services), the amount expended has recently decreased. Part of this decrease may be due to the fact that parole staff who were formerly under NDCS now are independent of NDCS.

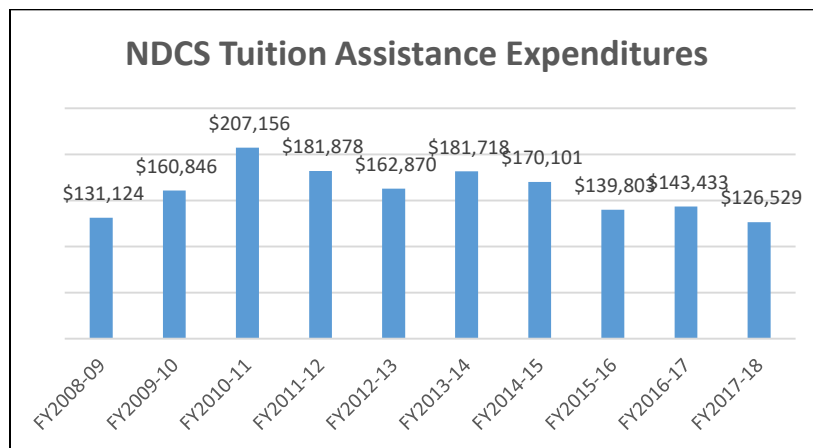

FIGURE 29: SOURCE 2019 DAS PERSONNEL ALMANAC

Other Ideas

Numerous ideas regarding staffing have been shared with NDCS during the past four years by the OIG. One suggestion recently made to the OIG was that NDCS consider hiring individuals who have a criminal history but have made significant changes in their lives and are qualified for the positions. While there may be some concern about hiring ex-offenders, they would likely bring a relatable background to their position and be positive role models for incarcerated individuals. Another suggestion recently provided to the OIG was that when Human Resources attends job fairs or other employment events that they bring along an actual facility staff member so that they can be part of the team that is recruiting individuals. These staff would possible be more relatable to applicants and directly answer questions on what it is like to work as a security staff member in a correctional facility.

New Normal

In each OIG annual report there have been sections titled “New Normal.” They discussed how when a situation gradually worsens over time each year becomes a new normal and the view (at least for some) becomes that it really is not that much worse than last year. However, if one were to take a step back and compare the current year to the situation five or ten years ago, then one would see that significant changes have taken place over that time period. Data shows this to be the case in overtime, turnover, overcrowding and other measurements. The 2016 OIG report stated the following:

The gradual worsening of these problems highlighted previously is something that needs to be remembered and focused on as change takes place in NDCS. It is important that people throughout NDCS take a step back and have a full understanding of the changes that have taken place over a period of five, 10 and even 20 years. This applies to vacancy rates, overtime rates, overcrowding, and turnover rates. NDCS, the Legislature, and other interested parties must look at change over a period of more than one or two years in order to accurately assess actual differences within NDCS.²⁸

As stated in past reports, this continues to be the case with NDCS.

28

[http://nebraskalegislature.gov/FloorDocs/104/PDF/Agencies/Inspector General of the Nebraska Correctional System/600 20160915-141014.pdf](http://nebraskalegislature.gov/FloorDocs/104/PDF/Agencies/Inspector%20General%20of%20the%20Nebraska%20Correctional%20System/600%2020160915-141014.pdf) (pages 19-20)

NSP AND TSCI UPDATES

The two facilities with the most significant staffing challenges, as seen in previous data in this report, are TSCI and NSP. However, there are some differences between the two facilities. During the past several weeks there have been many times that both facilities have been operating at or below minimum or critical staffing levels. When this happens the operation of the facility is impacted and results in many things, including visitation not taking place, gyms, library and education areas not being opened, meals being delayed, programs not taking place, and delays in medication being provided to inmates. It is also important to note that one significant difference between the two facilities is that TSCI is operating near the capacity it was designed to hold. NSP is operating at approximately 190% of its design capacity, making it a much more crowded facility.

Experience matters when it comes to correctional staff positions. This was made clear in 2015 after the first riot at TSCI. NDCS hired Tomas Fithian from the Washington Department of Corrections to conduct and write a critical incident review of the riot. Mr. Fithian wrote:

TSCI maintains a higher than normal vacancy rate. This review identified that 60 positions out of a total of 431 authorized are considered true vacancies, which drives significant overtime, recruitment, and retention issues...It is important to note that of the 210+ custody staff that are employed at TSCI, over 35% have less than two years of NDCS experience. Including custody staff with a hire date of 2013 to 2015, the percentage grows to nearly 45%. The impact on facility operations, including consistency and standardization, is greatly impacted by a large percentage of inexperienced staff.²⁹

In August, the OIG requested and received staffing information from TSCI and NSP.

At NSP, 118 of the 561 authorized positions at NSP are vacant (84 of the 324 protective services positions are vacant). Of the 240 protective services staff that were then employed at NSP, slightly over 35% had less than two years of NDCS experience. This is the same inexperience level found by Mr. Fithian at TSCI prior to the riot.

At TSCI, 96.5 of the 409.5 total positions at TSCI are vacant. There are currently 69 protective services positions vacant (169 filled out of 238) that are based in Tecumseh. Understanding this does get a bit tricky because 80 protective services positions for TSCI are actually classified under OCC and are the special detail positions that drive to Tecumseh each day and work approximately five hours of their eight hour shift as they receive compensation during their commuting time. At the time of the request, 69 of those 80 positions were filled. As a result, in total there are 318 protective services positions and there are 78 vacancies.³⁰ Mr. Fithian found that prior to the 2015 riot, 35% of those positions had two years or less of experience. That has now climbed to 48%, which is primarily due to the fact that 62 of the 69 OCC Special Detail staff have less than two years of experience.

At NSP there are other issues that have arisen including:

²⁹ 2015 Fithian Report, pages 29-30

³⁰ As noted previously, since those 80 OCC Special Detail positions don't work eight hours at the facility they are actually more comparable to 50 positions and that results in an additional 30 vacancies.

- The law library is closed repeatedly at NSP. The Ombudsman’s office has proposed having tablets available with law library materials on them that inmates can check out. The OIG has proposed having computers in each unit that have law library access. Neither of these suggestions that are aimed at assisting the inmate population have been accepted by NDCS;
- One inmate wrote: “It is hard to get the case workers and case managers to effectively perform their duties of helping people advance through the system because they are consistently forced to perform other duties such as custody staff, which overworks them and stresses them out and takes away from the normal tasks of their assigned duties;”
- A new 100 bed dormitory is being constructed at NSP. This will take additional staff to monitor the project and to work with the contractors;
- Requests for protective custody increased in August to approximately 45 inmates;
- Experienced staff have shared concerns about interns and trainees being placed in housing units without appropriate experience, training and supervision;
- Medical travel orders have been cancelled or postponed due to a lack of staff; and
- The number of misconduct reports dismissed because they are not heard within the seven day period as required in NDCS policy is much higher than in other facilities. For comparison, this happened 173 times in July 2019 at NSP but only 25 times at LCC during that same month.

Last October, the OIG submitted a supplemental report on NSP due to concerns about staffing, housing, and other issues within the facility. The report discussed positive and negative developments at the facility, as well as challenges to operating it as NDCS would like to operate it. Several observations and recommendations were made to NDCS in the report.

One observation shared that information on the disproportionate share of NDCS inmates in Housing Units 2 and 3 at NSP who were black inmates. The charts below show what that data was a year ago and what it is today. The numbers are basically the same. Additional reviews of the population in Housing Unit 4B, which is a modified operations unit that is not considered restrictive housing yet has a lot of the features of a restrictive housing unit, and the Segregation Unit, which is a restrictive housing unit that was built in the 1950s, also reveal some issues with disproportional populations.

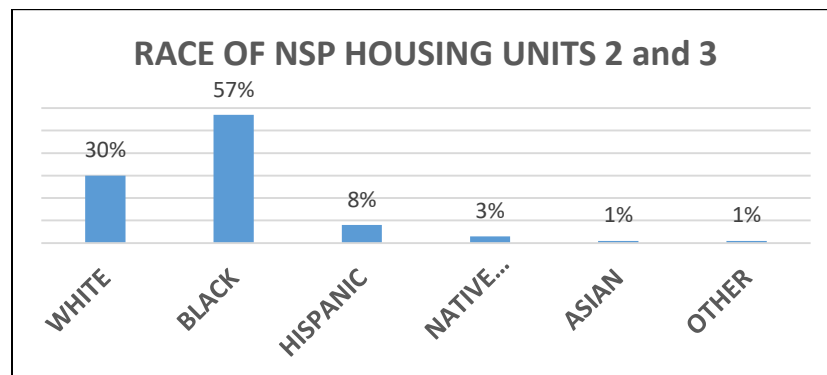

FIGURE 30

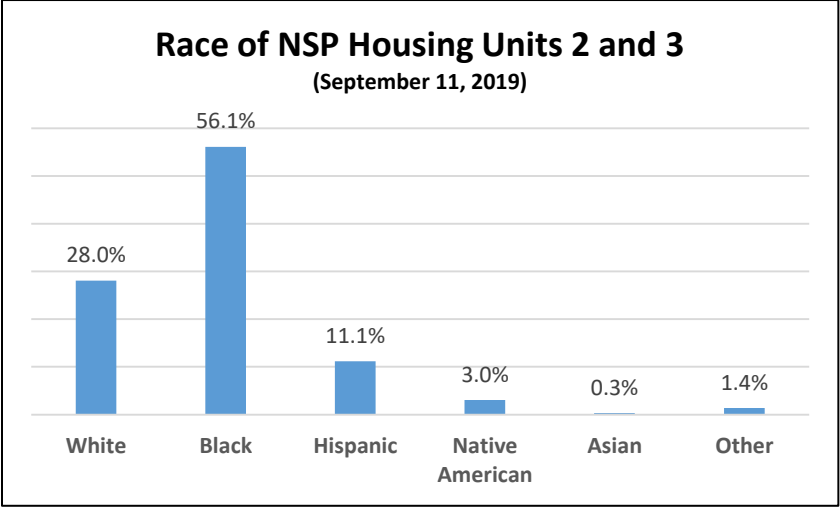

FIGURE 31

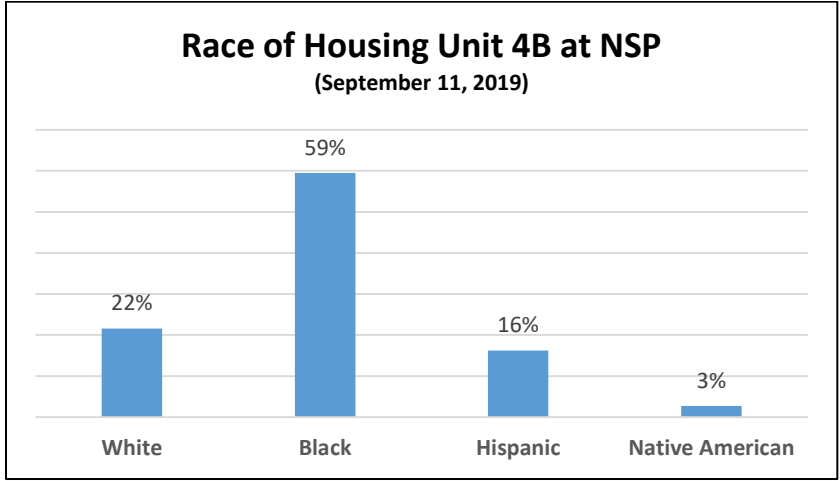

FIGURE 32

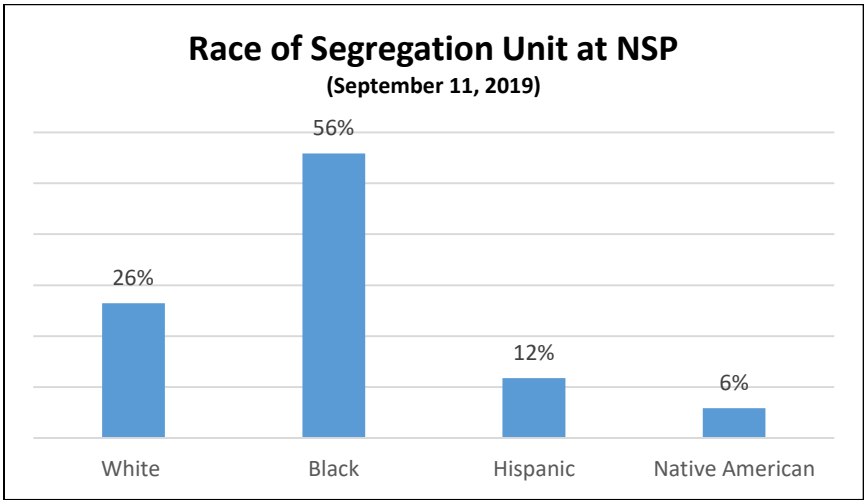

FIGURE 33

Other observations included:

- The unemployment or underemployment of those in the Housing Units 2 and 3;
- The impact, perceived or otherwise, of the tightening of the yard and movement restrictions;
- The potential need for a detoxification center at NSP which would allow for substance abuse users to voluntarily check themselves in to sober up and thereby reducing the demands of drugs within the facility;
- The need for increased access to the law library; and
- The need for involvement and communication between administration and staff who have “boots on the ground” and have to carry out changes.

The recommendations made to NDCS by the OIG in the report included the following:

- 1) Currently, staff at the Tecumseh State Correctional Institute have the opportunity to be paid more for merit and longevity reasons. This pay program should be provided to staff at NSP in an effort to reduce turnover and vacancies.
- 2) NDCS should review options related to the conversion of the external housing units into programming space and construct new minimum housing units that are rehabilitative and more efficient.
- 3) Review the need to construct a second indoor recreation area for the facility.
- 4) Place cameras in identified “blind spots” in the Internal housing units and review security camera needs throughout the facility.
- 5) Review the use of the kitchen area in internal housing units and determine whether they can be used as a vending area or a recreation area.³¹
- 6) Provide for access to a law library computer in Housing Units 2 and 3.
- 7) Develop a plan in the near future to address the nursing shortage. (Review past OIG recommendations if necessary.)
- 8) End double bunking in restrictive housing so that the ACA standards will be met.
- 9) Convene a short-term work group consisting of unit staff and inmates to discuss other options for creating day room space or out of cell opportunities within a living unit or connected to a living unit.
- 10) Establish a goal to “right-size” Housing Units 7 and 8 so that they can function in a safe and productive manner. If these facilities had 100 men in them instead of 200 men the environment would be much better for the staff and the inmates.
- 11) NDCS and the OIG should work together to conduct similar assessments of other state correctional facilities.³²

NDCS responded to the recommendations in July 2019 and the OIG issued a response to those responses in August 2019.³³

³¹ These are areas across from the staff offices in Housing Units 1-5 that were originally designed to serve food to the population.
³² https://nebraskalegislature.gov/FloorDocs/105/PDF/Agencies/Inspector_General_of_the_Nebraska_Correctional_System/679_20181011-082108.pdf (page 25)

³³ Attachment B: 2018 NSP Supplemental Report Recommendations Spreadsheet and NSP Report

In the fall of 2018 NDCS announced that they would be requesting \$15.2 million from the Legislature in order to expand the food preparation and dining area at NSP, as well as to increase programming space. This would have had an impact on the design capacity of the facility as well as the ability to deliver additional programs. However, this request was removed from the NDCS budget request and replaced with a request to construct a 384 bed high security unit at LCC at close to \$50 million.

September 2019 NSP Lockdown

On September 4, 2019 Director Frakes announced that he was “taking a no-holds-barred approach to stemming a recent uptick in assaults, drug exposures and contraband at the Nebraska State Penitentiary. The entire facility has been placed on lockdown since this morning.” He also stated, regarding the lockdown, “That will continue to be the case until further notice. During this time we will have staff members doing organized and intensive searches of housing units, looking specifically for alcohol, drugs, weapons and cell phones.”³⁴

On September 6, 2019 NDCS announced that the lockdown had ended and that the facility would step down to modified operations, meaning there would be limited and controlled movement within the facility. NDCS announced that “The penitentiary went into lockdown on Wednesday morning so that organized and intensive searches could be conducted of cells, restrooms, dayrooms and other spaces.” Director Frakes also said, “The decision to shut down activity across the facility was not spurred by any single incident. But, there was no doubt that strong and direct action needed to be taken based on the number of recent assaults and discovery of contraband.”³⁵

The OIG visited NSP on September 6th during the lockdown and observed cell searches in Housing Unit 3 and visited with staff in Housing Unit 4 and inmates in Housing Unit 5. As the OIG left NSP, two staff were discussing the searches and one was expressing his discontent with the fact that only part of Housing Unit 6 was searched before the inmates were allowed movement in that unit. Later that day, the OIG was contacted by staff members who expressed their concern that parts or all of some of the housing units had not been searched. The OIG was able to verify these concerns and on September 11th the OIG contacted NDCS and asked for their position on why those searches did not take place. They responded on September 12th by sharing that:

For safety and security reasons, the agency does not provide specific details on areas searched, when they are searched, how they are searched or why. Security strategies are shared on a need to know basis. This is necessary for good security management.

It is concerning that the entire facility was not searched and that entire housing units were not searched after NDCS publicly shared all of their concerns about the status of that facility and the negative impact that contraband was having at the facility. It is also concerning that NDCS acknowledges that they didn’t search those units but then states that it was part of their security strategy. It is difficult to comprehend how not searching entire housing units is a strategy that leads to a more safe and secure facility, for staff, inmates, and ultimately the public.

³⁴ Attachment C: September 4, 2019 News Release

³⁵ Attachment D: September 6, 2019 News Release

One final note on the lockdown. Information provided to the OIG regarding the status in Housing Unit 2 shared that even though the lockdown for the facility ended on September 6th it wasn't until September 9th that things returned to normal for those in that housing unit. According to this individual, on September 6th, 7th and 8th only 14 inmates were allowed to shower each day. During the non-shower times inmates were kept in their cells with no access to common phones, the email kiosk, hot water, ice or the microwave. Each meal was served in their cell. Housing Unit 3 had a similar experience. On September 7th and 8th the inmates in those two housing units were able to observe that inmates in Housing Units 1 and 5 were allowed movement, day room time, and access to other parts of the facility. The OIG will follow-up on this information in the weeks ahead.³⁶

As was previously shared, the incidents leading up to the lockdown in September 2019 were not unusual. However, it is important to revisit a part of the 2019 NSP Supplemental Report regarding an assessment that was completed by a former NDCS official at the request of Director Frakes. As shared in the supplemental report, the assessment included the following:

- *The staff member was instructed to conduct an assessment of NSP due to the overwhelming challenges regarding staff vacancies, inmate unruliness, low morale, and overall issues plaguing NSP;*
- *Staff interviewed ranged in age from 19 to 61 years old and service time ranging from 6 months to 28 years;*
- *Six inmates were interviewed during the process;*
- *Four themes emerged during the staff conversations:*
 - *Training;*
 - *Team consistency;*
 - *Treatment of inmates; and*
 - *Leadership.*
- *Two themes emerged during the inmate conversations:*
 - *Consistency between shifts; and*
 - *Treatment of inmates.*
- *Four findings and accompanying recommendations were made to Director Frakes and Deputy Director Sabatka-Rine as a result of these efforts:*
 - **Training:** *Staff relayed that training that they received at the Staff Training Academy is not relevant to what is endured once they graduate and go to a facility. More than often, a new hire is placed in the control center without any training and remains there for one to two weeks. Senior officers, Sergeants and Lieutenants also do not feel that it is their responsibility to teach, coach and mentor new hires, so new hires feel secluded from the team.*
RECOMMENDATION: *Recommend that NDCS find the best Sergeants and Lieutenants across the agency, bring them to NDCS (compensated) as a mentorship program to teach, coach and train supervisors.*

³⁶ On September 13-14th, NSP again went into modified operations due to operating below their critical staffing level. Housing Unit 4 was again shutdown. Visitation was cancelled. The library and gym were closed. NCYF ran below their minimum staffing level due to staff being sent to NSP. CCC-L also operated below their minimum staffing level due to having to send staff to a hospital to guard a NSP inmate. Staff at OCC were required to stay past their shifts due to staff being sent to NSP from OCC. It is unclear if anything else was impacted as NDCS had not notified the OIG despite a previous agreement to do so. This was all information obtained through various sources by the OIG.

- **Team Consistency:** *Every staff member that was spoken to relayed that going to a team concept would alleviate a large portion of issues and challenges. Rather than having many utility posts, where an officer works in different housing units daily, maintain a team concept, where all three shifts are the same individuals. This creates trust amongst the officers, consistency within the team, and will assist with maintaining order and discipline among the inmates, which was also a complaint from the inmate population.*
RECOMMENDATION: *Recommend that NDCS try a pilot program of the team concept. It had been done in the past and according to senior staff it worked categorically well.*
- **Treatment of Inmates:** *This finding was found between staff and inmates. Although I did not find any incident reviews (staff did say they did write it up), there are some staff who purposely treat inmates poorly and provoke inmates to conduct bad behavior. One incident described in the assessment was quite alarming but several staff and inmates shared that this was the norm throughout NSP.*
RECOMMENDATION: *Again, recommend a mentor program to alleviate this happening in the future. One example would be that NDCS initiate a mentor program based off the military program of assigning a 'sponsor' that would meet with new hires going through the academy at week two. This sponsor would be the primary point of contact for the new hire in the facility they would be assigned to and stay with them during the entire training or probation period.*
- **Leadership:** *This was the main theme throughout every discussion with staff that if remedied, would alleviate most, if not all the challenges NSP and NDCS face. Supervisors do not take the time to teach, coach, or train new hires, or sustain the training of senior staff. It is their opinion (field staff) that there is no leadership, only supervisors and managers. This permeated the facility to take on the role of coming to work, doing the minimal amount required and then go home.*
RECOMMENDATION: *Revise curriculum of the Leadership Academy to concentrate on senior leaders. Focus on taking care of staff, showing concern for their well-being, promoting professional development, along with focusing on internal development to make the individual a better leader. Also, recommended a mentorship program where NDCS brings the best leaders across the agency into NSP.³⁷*

As shared last year, the OIG finds this to be a credible assessment and that the recommendations appeared to be sensible strategies aimed at addressing the identified problems. The OIG would recommend an expansion of the recommendation that NDCS bring in the best Sergeants and Lieutenants across the agency as a mentorship program by also including Majors and utilizing former staff to assist in that effort.

There are some steps being taken at NSP that are encouraging. They recently held a job fair in their parking lot and did an excellent job of marketing it. This brought in some possible

³⁷

[https://nebraskalegislature.gov/FloorDocs/105/PDF/Agencies/Inspector General of the Nebraska Correctional System/679_20181011-082108.pdf](https://nebraskalegislature.gov/FloorDocs/105/PDF/Agencies/Inspector%20General%20of%20the%20Nebraska%20Correctional%20System/679_20181011-082108.pdf) (pages 21-23)

candidates for their facility. Their executive staff meet with new hires and staff during the staff training period and have also been speaking and recruiting at local colleges and other settings. There are also signs of stabilization and improvement in higher ranking security positions.

While most of this section is focused on NSP, it is clear that the OIG should conduct a similar in-depth review of TSCI sometime in the next year.

STAFF SURVEYS

The OIG has made use of the Google survey format to distribute a number of surveys to NDCS staff since December 2015. The surveys were never considered scientific. The true goal of these surveys was to collect much needed information and insight from those surveyed. The surveys found that many staff felt NDCS was not heading in a positive direction, that they did not look forward to going to work on most days, that they would not recommend a job at NDCS to a friend or family member, that the Legislature did not support NDCS employees and many other views. The surveys accomplished their goals and more.

This year the OIG did not send a survey to staff at NDCS primarily due to the amount of time that it takes to conduct such a survey and that NDCS was conducting two separate employment surveys. However, the surveys were highly valuable and this tool may be utilized in the future by the OIG.

In the 2018 OIG Annual Report, the OIG recommended that staff should be surveyed to see if the responses and results of the OIG survey were consistent with a past NDCS survey. Reasons for this recommendation included that research has shown that employee surveys are good tools for engaging employees since they provide employees with a chance to be heard. As mentioned previously the NDCS Retention Work Group did conduct something along those lines when they surveyed 469 NDCS staff in 2018/19.

INMATE POPULATION

As mentioned previously in this report, the overpopulation of NDCS correctional facilities continues into 2019. As of August 2019, NDCS was operating at approximately 157 percent of design capacity.³⁸ This is the same rate as a year ago but it is important to note that the population actually has increased by over 200 inmates but the system added 160 female community corrections beds. According to this measurement it remains one of the most overpopulated state correctional systems in the country. As a refresher, design capacity is the actual number of people a correctional facility was designed to serve, and provides a clear and absolute standard by which to measure a prison system's actual capacity (or degree of over-capacity) relative to the number of inmates that the system was designed to handle. These numbers in turn are a strong indicator regarding the system's ability to adequately manage and serve its inmate population.

The charts below show the gradual increase in the total population of inmates under the jurisdiction of NDCS, as well as the change in the design capacity under which the system has been operating. NDCS is expected to release new population projections by the end of 2019 due to signing a contract with a company to provide those projections. These projections will be important due to the fact that 384 new beds have been funded for LCC and an additional 100 beds have been funded at NSP. The projections will likely enable policy makers to determine whether any impact regarding design capacity will be realized. In other words, will the population continue to grow at a rate higher than those 484 beds? If so, then the system would actually be more crowded at the end of the construction of those beds. These projections will provide important and much needed information for NDCS and policy makers.

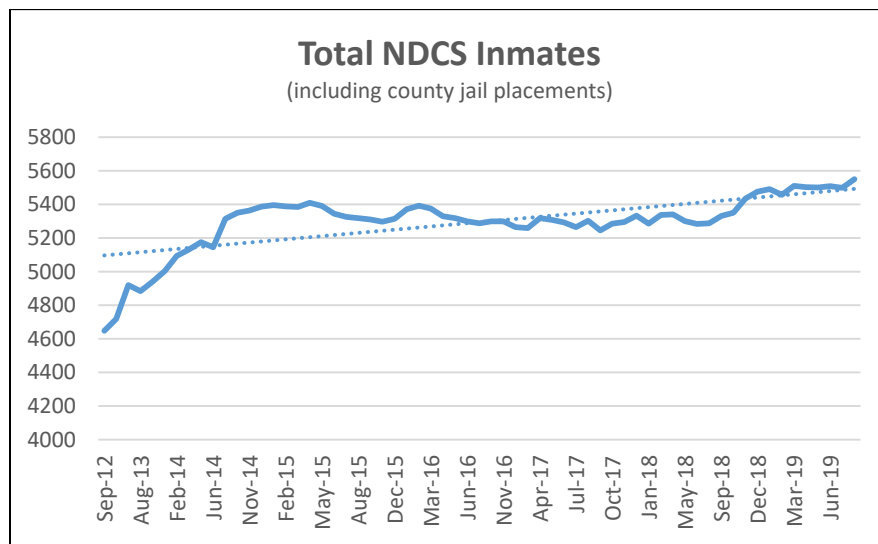

FIGURE 34

³⁸ This accounts for the 85 individuals who were state inmates but were residing in county jails.

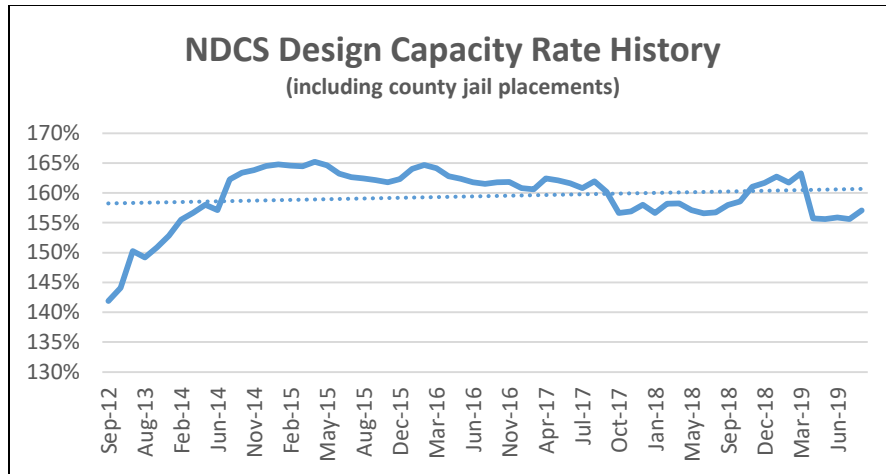

FIGURE 35

Recent populations at the facilities range from 57 at the Nebraska Correctional Youth Facility (NCYF) to nearly 1400 individuals at NSP. The corresponding design capacity has a range of 84% at NCYF to over 300% at DEC.

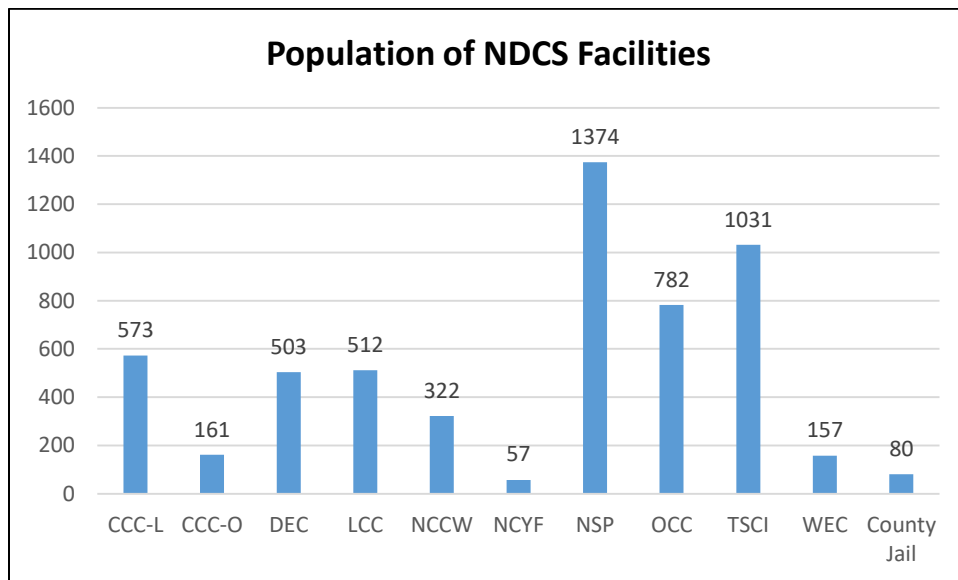

FIGURE 36

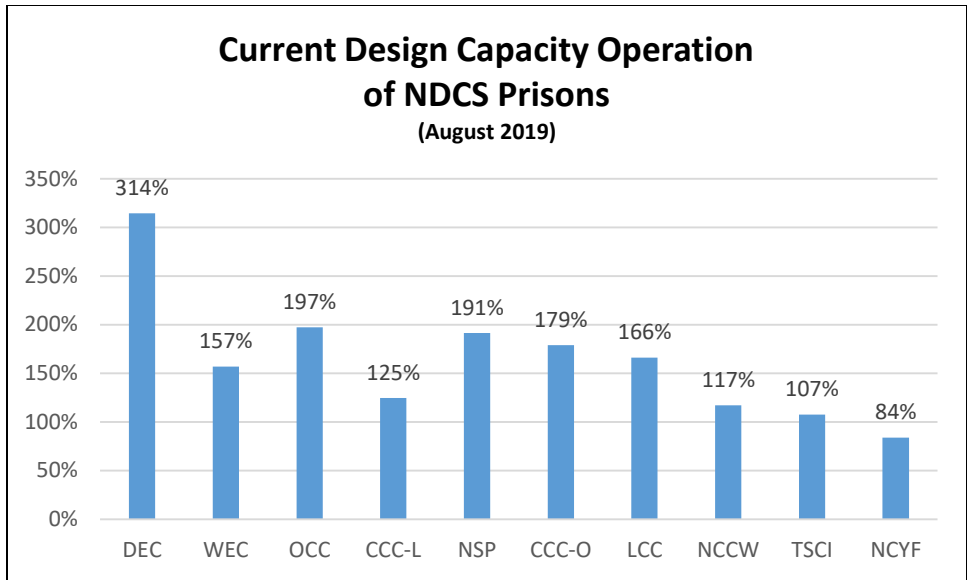

FIGURE 37

Marshall Lux, the former Ombudsman, used to separate out the adult male facilities that hold minimum to maximum custody inmates and group them. He did this to see what design capacity they were operating at as they contained most of the inmates in the system. As the charts below indicate, the initial grouping of these facilities show that they are operating at 165% of design capacity. However, when TSCI is taken out of the equation (since it is nearly impossible to operate them above 100% of their design capacity) this increases to nearly 200% of design capacity for the remaining facilities. The two facilities that currently hold female inmates are NCCW and CCC-L (160 beds of the total beds in that facility). In August 2019, when the two facilities are combined, they were operating at slightly above 90% of design capacity. This is mainly due to the fact that about half of the female beds at CCC-L at the time were empty.

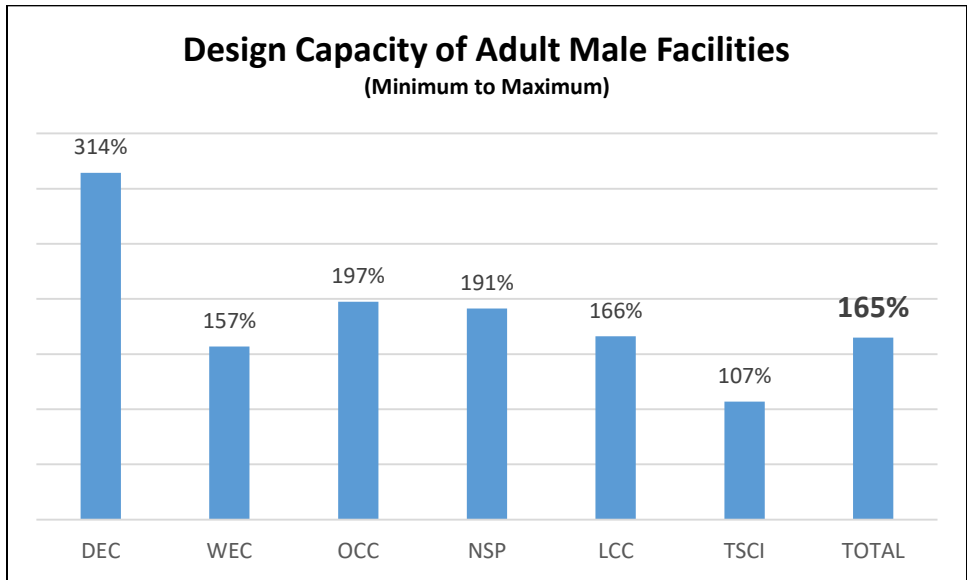

FIGURE 38

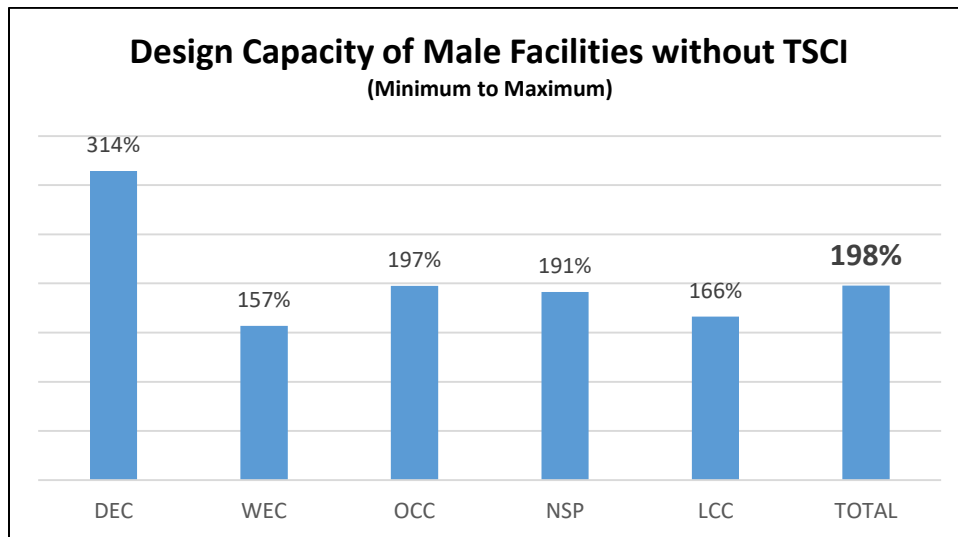

FIGURE 39

Incarceration Rates

As explained in the 2018 OIG Annual Report, there has been a perception on the part of some that since Nebraska’s correctional system is overcrowded that Nebraska must be incarcerating individuals at a higher rate than other states. Last year’s report shared that Nebraska had the 14th lowest incarceration rate in the nation in 2016. In 2017 this shifted slightly to the 15th lowest incarceration rate even though the number of people incarcerated in state prisons per 100,000 residents decreased from 283 individuals to 273 individuals. The national average was 471 people incarcerated per 100,000 residents in 2016 and this decreased to 440 people incarcerated per 100,000 residents in 2017.³⁹ Nebraska has a lower incarceration rate than any of its bordering states.

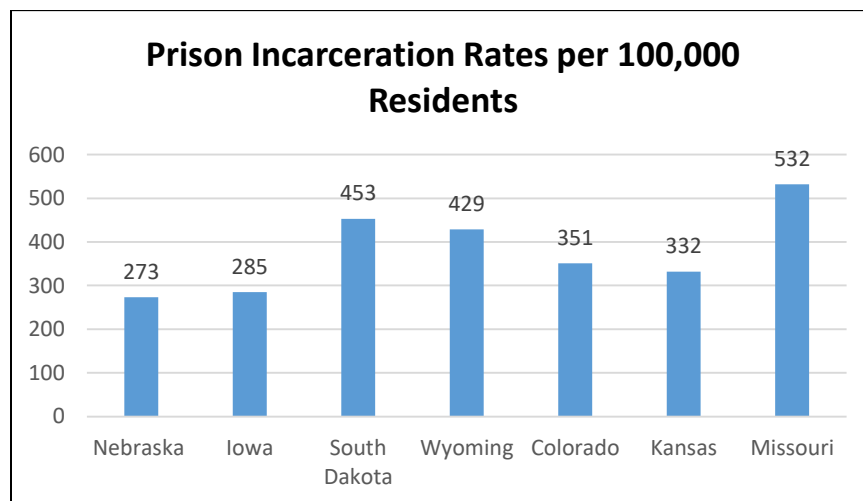

FIGURE 40: U.S. BUREAU OF JUSTICE STATISTICS FOR 2017

³⁹ www.sentencingproject.org

While Nebraska does compare well against our neighboring states there are other states that do have significantly lower incarceration rates. Reviewing the systems of those states may be worth the effort as incarceration rates are part of the prison population equation.

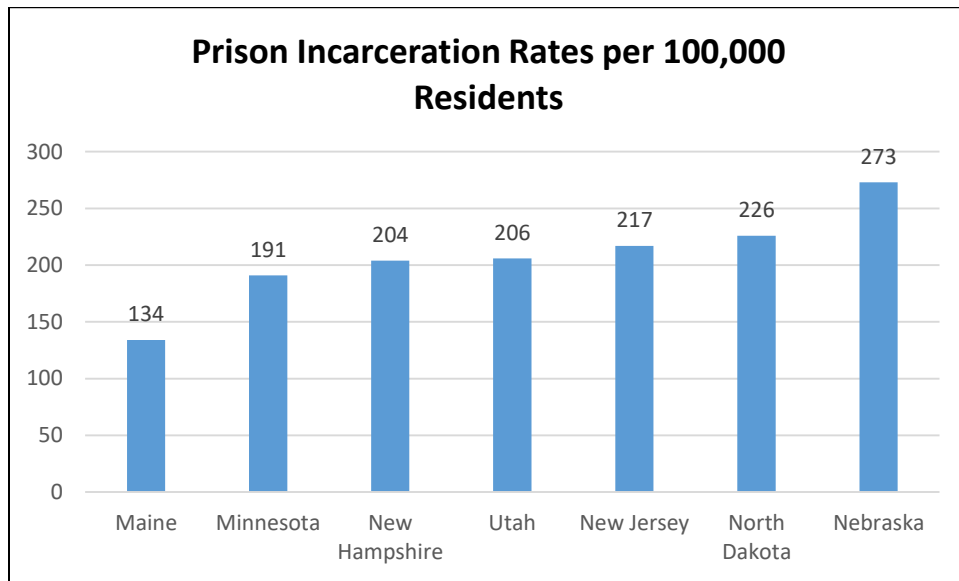

FIGURE 41

Within incarceration rate data there are discrepancies found when comparing different groups of people. Men are traditionally incarcerated at a much higher rate than women. Nebraska has the 10th highest racial disparity when comparing incarceration rates of black and white individuals. In Nebraska, a black individual is incarcerated at a rate 8.4 times higher than a white individual.⁴⁰ This is a slight drop from 2016 when it was 8.7 times higher. Nebraska had the same ranking for each of those two years (28th highest racial disparity) when comparing incarceration rates of Hispanic and white individuals. In Nebraska, a Hispanic individual is incarcerated at a rate 1.2 times higher than a white individual.⁴¹

Nationally, prison and jail incarceration rates have continually grown for over four decades. The growth in these rates can be found in the next chart.

⁴⁰ Ibid.

⁴¹ Ibid.

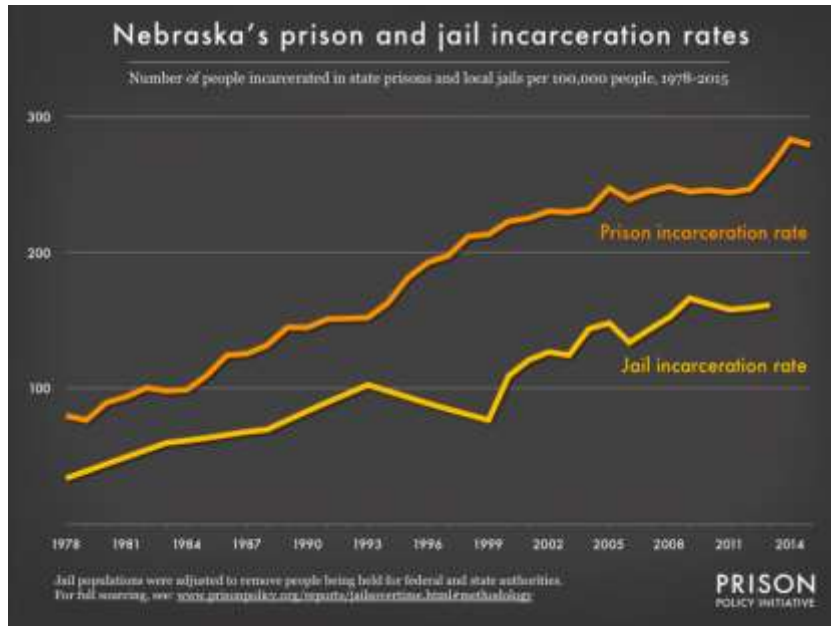

FIGURE 42

Crime Rates in Nebraska

When examining the changes in incarceration rates and prison population researchers will also compare these statistics to crime rates. The Nebraska Crime Commission tracks crime rates in Nebraska going back to 2000. These crime rate statistics include six measurements: Actual Total Offenses, Actual Violent Offenses, and Actual Property Offenses, and the number of each of those types of offenses per 1000 people living in Nebraska. The 2018 OIG Annual Report utilized data from the Commission from 2000, 2005, 2010, 2015 and 2017. Generally the crime rates decreased during that period, but have increased in the last few years, especially so in the cases of violent crime rates. The data for 2018 is not yet available but there is value in sharing the data from last year's report regarding Nebraska's crime rates.

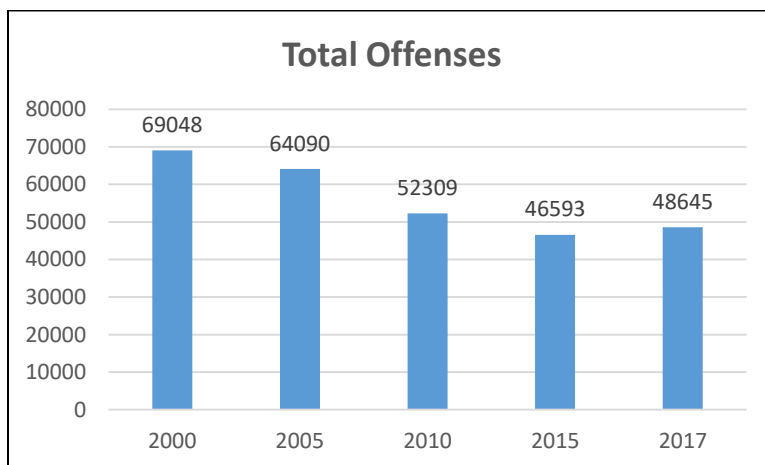

FIGURE 43

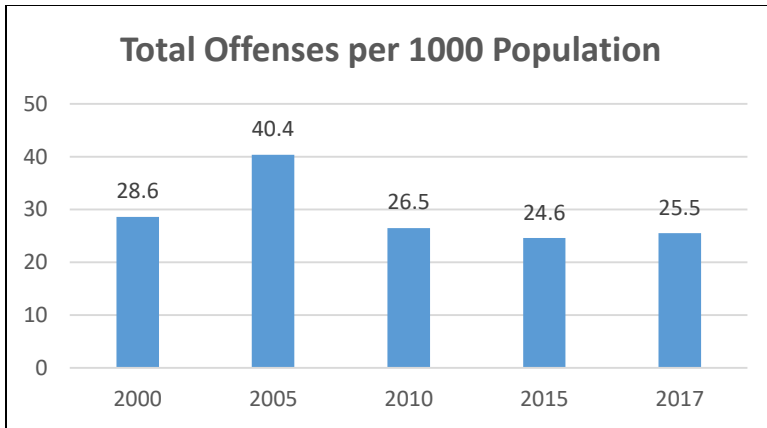

FIGURE 44

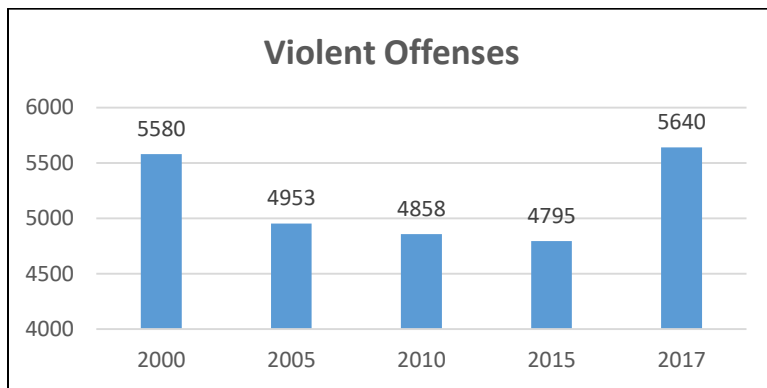

FIGURE 45

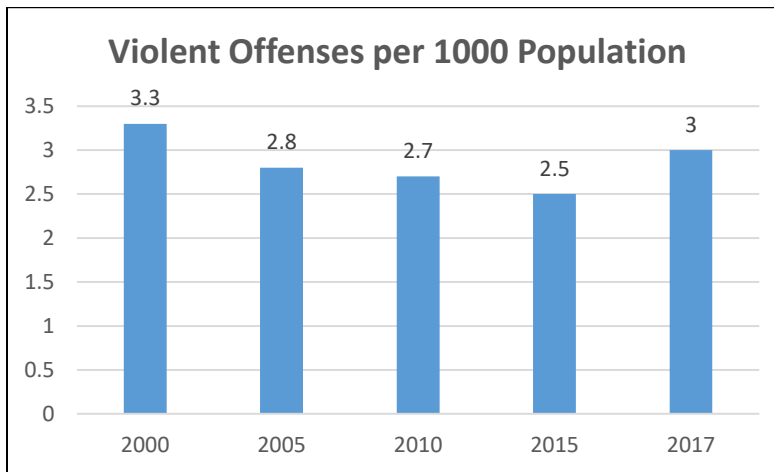

FIGURE 46

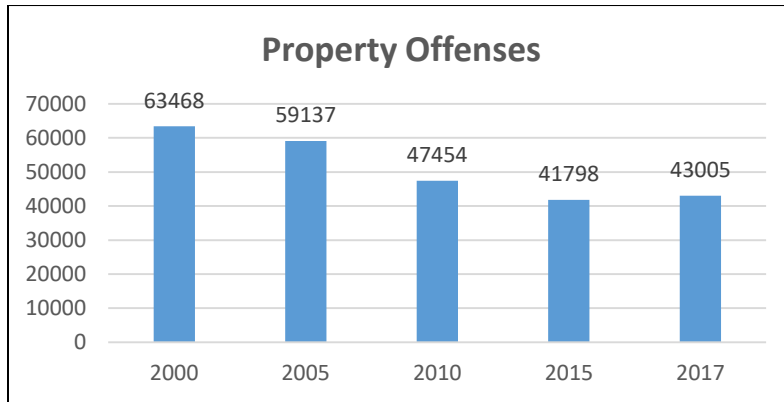

FIGURE 47

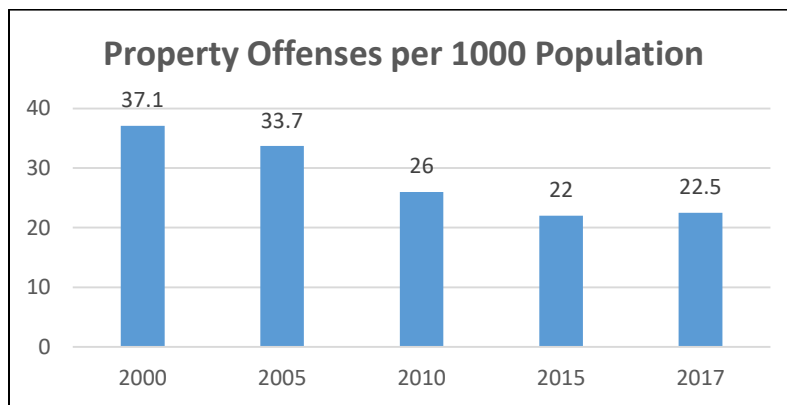

FIGURE 48

Correctional System Overcrowding Emergency Act

The Correctional System Overcrowding Emergency Act was enacted into state law in 2002 and the specifics for how it would be administered are found in **Neb. Rev. Stat. § 83-962**, which reads as follows:

83-962. Correctional system overcrowding emergency; Governor; declaration; when; effect.

(1) Until July 1, 2020, the Governor may declare a correctional system overcrowding emergency whenever the director certifies that the department's inmate population is over one hundred forty percent of design capacity. Beginning July 1, 2020, a correctional system overcrowding emergency shall exist whenever the director certifies that the department's inmate population is over one hundred forty percent of design capacity. The director shall so certify within thirty days after the date on which the population first exceeds one hundred forty percent of design capacity.

(2) During a correctional system overcrowding emergency, the board shall immediately consider or reconsider committed offenders eligible for parole who have not been released on parole.

(3) Upon such consideration or reconsideration, and for all other consideration of committed offenders eligible for parole while the correctional system overcrowding emergency is in effect, the board shall order the release of each committed offender unless it is of the opinion that such release should be deferred because:

(a) The board has determined that it is more likely than not that the committed offender will not conform to the conditions of parole;

(b) The board has determined that release of the committed offender would have a very significant and quantifiable effect on institutional discipline; or

(c) The board has determined that there is a very substantial risk that the committed offender will commit a violent act against a person.

(4) In making the determination regarding the risk that a committed offender will not conform to the conditions of parole, the board shall take into account the factors set forth in subsection (2) of section 83-1,114.

(5) The board shall continue granting parole to offenders under this section until the director certifies that the population is at operational capacity. The director shall so certify within thirty days after the date on which the population first reaches operational capacity.

In the 2016 OIG report, the OIG made a recommendation to NDCS to “Work jointly with the Office of Parole Administration (now the Division of Parole Supervision) and the Board of Parole to present a plan to the Governor and the Legislature detailing how a correctional system overcrowding emergency would be administered.” The same recommendation was made in the 2017 OIG report. The Legislature passed a law (LB 841) during the 2018 legislative session that required the development of that report by NDCS, the Division of Parole Supervision and the Board of Parole to describe how the emergency would be administered. The report was issued in December 2018. It was a short report with little to no data or information about future needs should the emergency be declared. It also provided the Legislature and the public with no idea regarding what the impact would be if the emergency was declared and carried out.⁴² The report gives the impression that there will be no change as a result of the declaring of an overcrowding emergency on July 1, 2020.

The next table provides additional data on the potential impact of the implementation of the overcrowding emergency. If the population of NDCS is at the same level in July 2020 as it was in August 2019, 1133 inmates (if the county jail inmates were in the state system) would have to be released to reach 125% of design capacity. In order to reach 140% of design capacity 603 inmates would have to be released.

⁴² Attachment E: NDCS/Board of Parole December 1, 2018 Report

Aug-19	
Design Capacity	3535
County Jail Inmates	80
NDCS Facilities Population	5472
Total Inmates	5552
% of Design Capacity (without county jail)	155%
% of Design Capacity (with county jail)	157%
Inmate Population at 140% of Design Capacity	4949
Number of inmates that need to be decreased to reach 140% of design capacity (including county jail)	603
Inmate Population at 125% of Design Capacity	4419
Number of inmates that need to be decreased to reach 125% of design capacity (including county jail)	1133

FIGURE 49: OVERCROWDING EMERGENCY DATA

One other data point that needs to be discussed is the number of inmates actually eligible for parole. This number is always changing but on September 12, 2019 there were 893 inmates past their parole eligibility date. The Board of Parole has had the opportunity in nearly every one of those cases to place those individuals on parole in the past. Some may have been placed on parole but had their parole revoked. The rest have yet to be approved for parole. When the overcrowding emergency is declared, it is likely that the Board of Parole will take a longer look at these individuals but there may be a reason that they have not previously been placed on parole.

Population Goal

Past reports have discussed the need by policy makers to determine the population goal for the state correctional system. Is the goal 150%, 140%, 125% or even 100% of design capacity? The 2017 OIG report stated that:

“Even at 140% of design capacity, the system will remain stressed and overcrowded. According to the Bureau of Justice Statistics, even if Nebraska reached a population level of 140% of design capacity, it would still be the fifth most crowded system in the United States.”

There would be many benefits related to reducing the population, many of which have been or will be described in this report. Reducing the overcrowding situation would not only make Nebraska’s prison system more manageable and likely more safe, but it would also provide more beneficial outcomes for those who are in the correctional system and eventually leave the system and reenter society.

FACILITIES

New Construction

During recent legislative sessions the Department has received funding for multiple building projects.

1. In September 2017 a 100 bed dormitory at the Community Corrections Center–Lincoln (CCC-L) was finished. It cost \$1.55 million and produced a building that is 7488 gross square feet. At this time, it serves men who are on work release. It typically stays close to its capacity.
2. A 160 bed addition to CCC-L was finished in 2019. It is a unit for women in community custody and also has separate offices, classrooms, cafeteria and a visitation area. An appropriation of \$26 million was provided for the project and the building is 57,018 gross square feet. This consolidated all female community corrections beds, meaning that there are no female community corrections beds in Omaha. It currently houses approximately 100 women.
3. A \$75 million project at DEC and LCC was funded in 2017. It will establish a Reception and Treatment Center that will connect the Lincoln Correctional Center (LCC) and the Diagnostic and Evaluation Center (DEC). It will include a 32 bed skilled nursing facility that will be used for seriously or chronically ill inmates, and will primarily replace the skilled nursing facilities at DEC and NSP. It will also include a 32 bed secure behavioral health unit that will be intended to meet the needs of inmate with acute mental health or behavioral health needs. The inmates who will reside in this unit will likely be moved from a mental health treatment unit at LCC. The expansion will also include a new kitchen for the two facilities as well new space for administrative and staff support, visitation, intake and release, and other custody operations.⁴³
4. Using funds that went unspent for the 160 bed unit at CCC-L NDCS will build a 100 bed minimum security dormitory at NSP in the future. Ground was recently broken on this project and it should be finished in 2020.
5. The Legislature appropriated \$49 million during the recent legislative session to fund a 384 bed high security unit at LCC. Ground has yet to be broken on this project.

Existing Facilities

As explained in the 2018 OIG Annual Report, each of the ten correctional facilities face challenges with the way that they are currently constructed. Some of them have an antiquated physical plant that presents challenges to maintaining safety and security. Others have significant overcrowding issues and several have building maintenance issues.

⁴³ https://corrections.nebraska.gov/sites/default/files/files/41/fy17_strategic_plan_progress_report_0.pdf (pages 18-19)

NDCS is facing a maintenance backlog of over \$60 million in projects.⁴⁴ This presents additional challenges since NDCS is only addressing a small fraction of those projects each year. As the facilities continue to age, even more infrastructure issues will emerge which will add to that backlog.

There are also numerous core support needs for facilities throughout the system. These include such needs as recreational space, educational classrooms, dining and food service areas, visitation space, offices, programming space, work sites and many other needs. Many recreational spaces are severely overcrowded and NCCW, a facility that houses minimum, medium and maximum custody female inmates, does not have an indoor recreation area. There are many other examples of needs throughout the system.

Future Projects

In the September 2016 update of the NDCS Strategic Plan, NDCS laid out a number of projects that could be considered in the future. These were described in the 2018 OIG Report and can be found on pages 48 and 49 of that report. They will also be included later in this report. One project that was not included in that list but that NDCS originally requested funding for last year was a \$15 million project to update and expand many core support areas at NSP. At the time of the request, NDCS shared the following information regarding the request:

The NSP expansion project will address food preparation and dining needs for the population. It will provide additional programming space to replace temporary structures that were built more than 30 years ago. The expansion of infrastructure and programming opportunities provides improved engagement by the population, leading to greater reentry success.⁴⁵

This request was rescinded in January 2019 by NDCS.

Right-sizing

If NDCS does make a decision to request additional beds in the future, they should attempt to “right-size” other facilities. In order to “right-size” a facility beds would be removed so that it would begin to operate at the size it was intended to operate. For instance, if rooms at CCC-O, CCC-L and OCC housed four men instead of eight men the facility and the staff could provide much better oversight and support for those who reside there. The same can be said at most every male facility throughout the system except for TSCI and NCYF.

⁴⁴ According to the Legislative Fiscal Office the total maintenance backlog is \$61,946,129 which includes: Deferred Repair \$45,061,239; Energy Conservation \$2,401,760; Fire/Life Safety \$5,648,630; ADA \$2,334,500; Corrections Capital Program 913 - Security System Upgrades \$2,500,000; and, Corrections Capital Program 914 - Infrastructure and Maintenance \$4,000,000.

⁴⁵ <https://www.corrections.nebraska.gov/ndcs-submits-biennial-budget-request-and-strategic-plan-reduce-agency-turnover-improve-parole> (September 17, 2018 NDCS Press Release)

ASSAULTS AND CAMERA COVERAGE

During the past few years, the issue of inmate-on-staff assaults has emerged as a significant concern as public awareness regarding the assaults increased. In the past, data provided by NDCS indicated a consistent increase in staff assaults and a decrease in inmate-on-inmate assaults. In the last two OIG Annual Reports concerns were expressed about the accuracy of the inmate on staff assault data. NDCS has agreed to report all staff assault to the OIG but there have been many occasions when this did not take place. However, it is the view of the OIG that this is not intentional but rather that there are systemic problems associated with the reporting, inputting and sharing of these incidents. In addition, the assaults are typically broken down into three categories, including “Serious Injury.” Cases have been shared with NDCS about individuals who the OIG believes meet the definition of serious injury but are not reported as having received such an injury. The data recently reported to the OIG by NDCS indicates that during the past three fiscal years inmate on staff assaults have decreased from 232 to 146 through the first 11 months of the most recent fiscal year.⁴⁶

In the past, NDCS had data on inmate on inmate assaults. In fact, as inmate on staff assaults were increasing NDCS pointed to a decrease in inmate on inmate assaults as a positive step. During the past two years NDCS has not been able to provide any data on these assaults to the OIG due to not allocating staff time to review reports related to those assaults. Inmate on inmate assaults are key indicators of a facility’s health and should be accurately reported to the OIG and policy makers.

The OIG, as a result of having access to the NDCS information system and due to the reporting of many assaults to the OIG by NDCS Central Office, does continually review reports and videos of assaults on staff and inmates. The most accurate source of the actual events of the incident are when it is captured on a body camera. A staff member’s body camera has close up video and audio of the incident. The institutional cameras do not have audio. In addition, the OIG, as expressed in past reports, has learned that there are many blind spots in facilities where the institutional cameras do not cover specific areas. A specific recommendation was made to NDCS by the OIG regarding areas of housing units at NSP. These have yet to be addressed. An incident recently took place in one of the blind spots previously shared by the OIG and important parts of that alleged assault were not recorded. A few weeks later, another serious assault took place at NSP and only a few seconds and portions of that assault were able to be viewed. The events leading up to that assault were not captured nor was the most serious part of that assault.

To assist with the accurate capture of inmate on inmate and inmate on staff assaults, NDCS should continually enhance their efforts to cover blind spots in their facilities with their institutional cameras and increase the use of body cameras. Currently, LCC does not have any body cameras in their facility. However, they have units in which there are frequent incidents with inmates who are suffering from a mental illness. Body cameras in those settings would likely assist the facility in not only capturing those incidents, but also in training staff on how to better respond to, as well as de-escalate potentially volatile situations.

⁴⁶ Attachment F: NDCS Staff Assault Chart, July 24, 2019

RESTRICTIVE HOUSING

The 2018 OIG Annual Report contained over 20 pages of information on restrictive housing. It is an excellent resource on restrictive housing history and practices in Nebraska.

NDCS Restrictive Housing Report

Nebraska state law requires NDCS to issue an annual report regarding restrictive housing no later than September 15th of each year. The 2018 report included a large amount of information on restrictive housing practices, including relevant data.⁴⁷ The 2019 report was released on September 13, 2019 and is similar in nature to the 2018 report.⁴⁸ A quick review of the report found that it a good resource that should be reviewed by those interested in this important issue. The OIG has requested a meeting with NDCS staff responsible for the report later this fall to discuss the contents.

Legislatively Created External Restrictive Housing Work Group

An external work group was created in 2015 thru the passage of Legislative Bill 598. The group has been led by Director Frakes since their first meeting on September 15, 2015.⁴⁹ In the past three OIG reports concerns were expressed about this group not having the impact that the Legislature anticipated when it came to advising NDCS on policies and procedures related to restrictive housing practices. Members had left the group and the number of people attending the few meetings of the group had dwindled. There also was little overlap between the work of the Internal Restrictive Housing Work Group and the external work group.

As a result, the OIG worked with the Nebraska Legislature to amend the membership of the group, adjust some responsibilities and sunset the work group on December 31, 2021. The membership will now include six external members instead of four plus one non-voting member from the Legislature’s Judiciary Committee. It also eliminated NDCS positions that had no role in restrictive housing. As this was taking place in the Legislature, the Work Group had their first meeting of 2019. At the meeting, Director Frakes changed the format of the meeting. In the past, he invited all attendees to participate and have a seat at the table. At this meeting, only official members were allowed to sit at the table and participate in the meeting. The next meeting was held the week before the law went into effect so only the four external members were a part of the meeting, along with the NDCS staff members.

At that meeting, Director Frakes announced that he planned to update the rules and regulations for restrictive housing. These went into effect in 2016 and have not been changed since that time. The OIG has previously submitted suggestions for possible changes to these rules and regulations, including:

- Further defining the programming plan (for those in restrictive housing) by adding: “As much as possible, programming shall be focused on the individual needs of the inmate in the restrictive housing setting. Having a program that is focused on the specific needs of

⁴⁷ https://nebraskalegislature.gov/FloorDocs/105/PDF/Agencies/Correctional_Services_Department_of/602_20180917-123641.pdf

⁴⁸ https://nebraskalegislature.gov/FloorDocs/106/PDF/Agencies/Correctional_Services_Department_of/602_20190913-170633.pdf

⁴⁹ This was the first corrections-related meeting attended by the OIG.

that individual will allow them to reenter general population more quickly and more successfully, as well as stay in general population in the future." This language would establish an emphasis on specific and individualized programming for inmates in restrictive housing instead of a one size fits all programming approach where an inmate might take the same program over and over and over again;

- Add a definition of “closed custody” since that has not been defined;
- Expand the definition of active STG (active involvement in a gang) so that “active” means X number of days of active gang involvement instead of having it be open-ended;
- Establish a peer mentor program in at least three facilities by no later than July 1, 2020;
- Add language regarding the MDRT process that would state: "The MDRT shall vote on each decision and the vote shall be a part of the restrictive housing record of an inmate so that the Director and other LTRH participants are able to better understand the decision that was made by the MDRT." Currently no vote is recorded or accounted for, when, by having such a record the Director or other parts of the LTRH system will be able to better understand whether or not there was consensus among the MDRT;
- Add additional language that states the following: "If a living unit within a correctional facility does not allow inmates to be out of their cell for an average exceeding six hours per day over a five day period than that living unit shall be designated as meeting the definition of a restrictive housing. Once that designation is made the living unit shall follow all regulations related to restrictive housing and any data that is collected for other restrictive housing units will also be collected for this living unit. Once a living unit that receives this designation allows inmates to be out of their cell for an average exceeding six hours over a five day period the designation shall be removed. The applying and removing of this designation shall be reported to the Deputy Ombudsman for Corrections and the Inspector General for Corrections;" and,
- Add a prohibition to double bunking in a restrictive housing setting.

These recommendations were shared with the external members of the work group and have been previously been shared with Director Frakes and past members of the work group.

Vera Report

In 2015, the Vera Institute of Justice (Vera) began to work with NDCS to assist NDCS in decreasing its use of segregation (restrictive housing). A report was issued on November 1, 2016. As reported in past OIG reports, Vera put forward 25 recommendations. These recommendations included such things as:

- Support staff as they adjust to a disciplinary process that no longer includes Disciplinary Segregation as a sanction, and ensure that they have adequate alternative tools to respond to misbehavior and incentivize positive behavior;
- Identify potential unintended consequences that may arise from the elimination of Disciplinary Segregation—such as the overuse of Immediate Segregation in its place—and implement strong safeguards to protect against them;
- Enact firm policies that prohibit placing youth, pregnant women, and people with serious mental illness in any form of restrictive housing that limits meaningful access to social interaction, exercise, environmental stimulation, and therapeutic programming;

- Further strengthen procedural safeguards for placement in Longer-term Restrictive Housing (a segregation category established by the new rule), to ensure that it is truly used as a last resort, only when necessary, and for as short a time as possible;
- Improve the conditions of confinement in restrictive housing units to reduce the negative effects of segregation, including by increasing out-of-cell time and recreation, minimizing isolation and idleness, and providing opportunities for rehabilitative programming;
- Create a step-down program to encourage and facilitate successful transitions from restrictive housing to general population;
- Expand the capacity of mental health care services and ensure a therapeutic environment within Secure Mental Health Units;
- Continue to explore strategies to address staff vacancies, turnover, and burnout; and
- Expand vocational, educational, and therapeutic programming and activities for the entire population, including those in restrictive housing.⁵⁰

Since it has been nearly three years since this report was submitted, NDCS should consider publishing a report that provides updates on the reaction and implementation of the Vera recommendations.

Restrictive Housing Population

One of the goals of the restrictive housing changes was to decrease the number of people placed in such a setting. In November 2014, the total number of inmates in restrictive housing units was 319 and the total number of inmates in protective management units was 310. In August 2018 the numbers had increased to 414 inmates in restrictive housing units, and 473 inmates in protective management units. In September 2019, there were approximately 350 inmates in restrictive housing units and approximately 500 inmates in protective management units.

Since the fall of 2016 the number of individuals kept in a restrictive housing unit for at least 180 days has increased as well. In September 2016 there were 62 individuals who had been in a restrictive housing unit for at least 180 days. In early 2018 it had increased to 185 individuals but had decreased to 158 individuals by August 2018. NDCS has continued to reduce this number and on September 1, 2019 it was at 119 inmates. This is a reduction from the high of 185 inmates but about double what it was three years ago.

Of the 119 inmates who have been in restrictive housing for 180 days or more, 10 inmates have been in restrictive housing for over 1000 days and a total of 45 inmates have been in restrictive housing for over two years. NDCS, in data provided to the OIG, indicated that 30 of these individuals have been diagnosed with a serious mental illness.

Close Management Units and Mission Specific Housing's Impact on Restrictive Housing

The population in restrictive housing has been most impacted by changes in other types of housing units. In 2017 NDCS established a new category of living units that were not restrictive housing, and yet not general population. They called them “close management units” and they existed at TSCI and NSP.

⁵⁰ <http://www.corrections.nebraska.gov/pdf/Vera%20Institute%20Final%20Report%20to%20NDCS%2011-01-16%20v2.pdf> (pages 4-5)

Inmates may be placed in Unit 4B at NSP for 60 days if they commit certain rules infractions. While there, they have just enough out-of-cell time so that they are not considered to be in a restrictive housing placement. They experience significant restrictions when it comes to their routine movement and other activities. In many ways, this is just a step below restrictive housing. If they commit infractions while in there the 60 day clock may start over. In addition, staff shortages have greatly impacted the quality of life in Unit 4B as they end up being placed on modified operations with limited or no movement due to a lack of staff.

Every three years, each correctional facility is audited by the American Correctional Association (ACA). The ACA has specific standards that are reviewed by their auditors for compliance. At the most recent external audit in 2018, the ACA found that NSP did not comply with the following standard:

Standard #4-4132

CELLS/ROOMS USED FOR HOUSING INMATES SHALL PROVIDE AT A MINIMUM, 25 SQUARE FEET OF UNENCUMBERED SPACE PER OCCUPANT. UNENCUMBERED SPACE IS USABLE SPACE THAT IS NOT ENCUMBERED BY FURNISHING OR FIXTURES. AT LEAST ONE DIMENSION OF THE UNENCUMBERED SPACE IS NO LESS THAN SEVEN FEET. IN DETERMINING UNENCUMBERED SPACE IN THE CELL OR ROOM, THE TOTAL SQUARE FOOTAGE IS OBTAINED AND THE SQUARE FOOTAGE OF FIXTURES AND EQUIPMENT IS SUBTRACTED. ALL FIXTURES AND EQUIPMENT MUST BE IN OPERATIONAL POSITION.

In the response to this finding by the ACA auditors, NSP submitted that “Inmates at NSP are confined in their cells for less than 12 hours per day. Inmates may leave their cells for approximately 12 hours a day with the exception of count times.” However, this clearly does not apply to the men in Unit 4B.

Unit 2B in TSCI holds individuals who have agreed to participate in The Challenge Program (TCP). TCP is a type of restrictive housing transition program that has three phases for those who meet NDCS criteria for participating in the program. The first phase takes place in restrictive housing. The last two phases take place in Unit 2B. It can take up to a year or longer to complete the three phases. Once again, there is limited movement and out-of-cell time for the men in these units and it also may be considered as just a step below restrictive housing. It is not a general population unit.

LCC recently made changes to units with mentally ill inmates. Previously, inmates in these units had very little out-of-cell time and were considered in the restrictive housing population. Recent changes converted restrictive housing beds to limited movement beds and changed the secure mental health unit to a skilled mental health facility. This is a work in progress but concerns about out-of-cell movement and restrictions have been shared by individuals in those settings. NDCS has indicated that these individuals receive at least four hours of out-of-cell time per day but earlier this year an inmate in that setting filed a grievance due to his not getting enough out-of-cell time. The response to the grievance was, “Unit and Behavioral Health staff report that you are having an opportunity for at least 10 hours a week out of your cell for yards, showers,

groups, day room time, and individual time.”⁵¹ He appealed the first response to the grievance and the response to the appeal was:

*Records show that you are being offered out of cell time a significant amount of hours per week. You are at the level that you will be offered up to four out of cell hours per day and up to 24 hours out of cell per week. You are not getting consistent time out of your cell but this is improving each week. Please continue to be patient as the C-2 program is still making changes and improvements on a consistent basis. I am receiving reports from the staff to see where we are at. I will address with them and will have the Unit Manager come up with a plan of action. Please give me some time to check on this.*⁵²

As expressed previously, the changes to this unit are new and it is evolving. It is key that NDCS continues to monitor the out-of-cell times in the settings at LCC, but also at the other units which fall somewhere between restrictive housing and general population. This is demonstrated when reviewing Title 72 of the Nebraska Administrative Code and its definition of general population:

*002.04 GENERAL POPULATION. All inmate housing areas that allow out-of-cell movement without the use of restraints, a minimum of six (6) hours per day of out-of-cell time, and regular access to programming areas outside of the living unit.*⁵³

Many of these individuals are currently residing in a setting that is not accurately defined by NDCS.

Double Bunking

In the past two OIG reports the OIG recommended that NDCS end the practice of double bunking in restrictive housing units for a number of reasons, including the safety of the two cellmates and the impact on their mental well-being. The previous Warden at TSCI ended the practice of double bunking there but it continues to take place at NSP.

As mentioned previously, every three years, each correctional facility is audited by the ACA. At the most recent external audit in 2018, the ACA found that NSP did not comply with the following standard:

ACA Standard 4-4141: All cells/room in segregation provide a minimum of 80 square feet, of which 35 square feet is unencumbered space for the first occupant and 25 square feet of unencumbered space for each additional occupant.

The following is directly from the 2018 audit:

FINDINGS:

The restrictive housing at NSP do not provide the minimum square footage in either total cell space (80 sq. ft) or unencumbered space (35 sq. ft).

⁵¹ May 31, 2019 Inmate Grievance

⁵² Ibid.

⁵³ https://corrections.nebraska.gov/sites/default/files/files/1/title_72_nebraska_administrative_code_chapter-1_restrictive_housing.pdf (page 4)

FACILITY RESPONSE:

Waiver Request

NSP was granted a waiver from the Commission during the panel hearings in 2015. NSP restrictive housing in the Control Unit has 62 square feet, with 37.10 square feet of unencumbered space.⁵⁴ There has been no change in the architectural design of the 59-year-old Control Unit. As in the past, there is no reasonable option to increase the size of cells in this building.

Restrictive housing cells in Housing Unit #4 also fall short of the minimum 35-square feet of unencumbered space per inmate. These cells are 78 square feet in size and are dual occupancy with a total of 45.13 square feet of unencumbered spaces. Divided by two occupants each individual has 22.56 square feet of unencumbered space.

While NSP continues to operate over its rated capacity, efforts are made each day to maintain the highest quality of life, health and safety for inmates and staff. Every step is taken to mitigate the effects of the increased population in an active, professional and caring fashion. Architectural modifications to increase the size of cells are not feasible given the physical layout/construction of the housing units; therefore, a waiver is being respectfully requested for this standard.

AUDITOR'S RESPONSE:

The auditor agrees with, and support of, the waiver request. There was no indication of any negative effects on the inmates in these housing units. Rather, the observation of these inmates indicated satisfaction with the space afforded.

The previous version of ACA Standard 4-4141 simply said, "All cells/room in segregation provide a minimum of 80 square feet, of which 35 square feet is unencumbered space." It would appear to not even consider the placing of two inmates in a restrictive housing cell. If it did then it may have been implied that the 35 square feet of unencumbered space should be doubled if there were two inmates in that cell, for a total of 70 square feet of unencumbered space.

The Auditor's response is interesting. First, the auditor agreed with and supported the waiver request about one year after the murder of an individual who was double bunked in a restrictive housing cell in Nebraska. The next sentence stated that there "was no indication of any negative effects on the inmates in these housing units." It is surprising that this was their conclusion due to the fact that two men are made to reside in a cell for 23 hours per day in conditions that do not meet the ACA standards. It is difficult to believe that the auditors surveyed those who lived in these rooms. The final sentence stated, "Rather, the observation of these inmates indicated satisfaction with the space afforded." This is a general and broad statement that does not match up with the experience of the OIG. One of the goals of the ACA is to "Develop standards that are based on valid, reliable research and exemplary correctional practice."⁵⁵ The OIG, despite

⁵⁴ These cells only contain one inmate.
⁵⁵

http://www.aca.org/ACA_Prod_IMIS/ACA_Member/About_Us/Our_History/ACA_Member/AboutUs/AboutUs_Home.aspx?hk=0c9cb058-e3d5-4bb0-ba7c-be29f9b34380

repeated efforts, has never found any research that supports double bunking in restrictive housing settings.

In the 2018 NSP Supplemental Report, the OIG again recommended that the practice of double bunking end “so that the ACA standards will be met.” In July 2019 NDCS responded by stating “ACA standards do not prohibit double bunking in restrictive housing.” In the 2018 NSP Supplemental Report, the OIG never indicated that the ACA standards stated that but rather focused on the compliance with the square foot standard described previously. This was shared with NDCS in August 2019.

It is also important to note that at an External Restrictive Housing Work Group meeting on December 17, 2015, Director Frakes stated in regards to restrictive housing practices: “If it is determined that the Department is not in compliance with the ACA standards we will look into what will need to be done. The goal is to have 100% compliance with ACA standards.”⁵⁶

The OIG agrees with Director Frakes and will once again recommend that the practice of double bunking in restrictive housing be ended so that the ACA standards will be met.

Placements

There are six criteria for placement in longer term restrictive housing and they are found in the following table which compares snapshots from 2017, 2018 and 2019.

Restrictive Housing Placement Criteria Usage	Snapshot on August 30, 2017	Snapshot on June 30, 2018	Snapshot on August 22, 2019
Serious Act of Violent Behavior	51.20%	48.60%	67.30%
Recent Escape or Attempted Escape	1.30%	0.80%	0.50%
Threats of Actions of Violence	17.90%	13.00%	8.90%
Active Membership in a STG (gang)	12.30%	17.10%	18.30%
Incitement or Threats to Incite Group Disturbances	1.80%	1.80%	1.00%
Presence in GP Will Create a Significant Risk of Harm	15.60%	18.60%	3.70%

FIGURE 50

While it is encouraging that the final category has decreased over time, questions should be raised regarding the significant increase in the first category. It is likely that the upcoming restrictive housing report by NDCS will address these placements.

⁵⁶ Meeting minutes from the December 17, 2015 External Restrictive Housing Work Group meeting

The Role of Intelligence

NDCS has a division within its agency specifically devoted to intelligence gathering (“Intel”). This has developed and grown over the past few years, and as explained in the 2018 OIG Annual Report appears to have become much more involved with day to day operations of NDCS, especially in determining who enters and leaves restrictive housing units. These concerns still exist and have been shared with NDCS leadership. Last year, the OIG recommended that NDCS review the operations of Intel and possibly utilize outside entities to assist with this effort, in order to determine whether changes need to be made to improve this division, so that it more closely adheres to standards of fairness. This was not acted upon.

Peer Support Pilot Program

NDCS, as required by their rules and regulations, established a peer support pilot program at NSP in 2018. The intent of the program is to train qualified inmates to be peer supports for their fellow inmates, especially those in restrictive housing. This was an idea promoted by members of the original external restrictive housing work group, and supported by Director Frakes. It is a promising program that is currently being implemented at TSCI as well.

The Challenge Program

The Challenge Program (TCP) was referenced earlier and is described in much greater detail in the 2018 OIG Annual Report. The three phases consist of taking Moral Reconciliation Therapy (MRT), the Challenge Series, Thinking for a Change (T4C) and Getting It Right. Together these last three phases should take approximately 52 weeks or one year to complete. The intent behind TCP is to transition inmates who meet certain requirements back to general population. This is a worthwhile intention and is somewhat modeled after transition programs that exist in other states.

As expressed in the past, there have been concerns raised regarding TCP. First, NDCS continues to have a difficult time convincing those inmates selected for the program to complete it. NDCS has shared that there are some inmate gangs who attempt to dissuade individuals from taking the program. There is also a belief by some inmates that they have to provide information to the Intelligence Division in order to participate or that others will think they did do that before entering the program. They also have a concern that they will spend up to a year in a setting that could be considered “Restrictive Housing Lite.”

Previously, it was mentioned that this setting falls between restrictive housing and general population and that it needs to be better defined. Another concern is that even though the TCP program is designed to assist inmates with transitioning into general population, they have relatively few chances to begin this transition. Their movements and privileges are quite limited. Many inmates appear to be willing to wait out NDCS to see if they will be released from restrictive housing without going through TCP. However, NDCS has made it clear that they will not be able to be removed from restrictive housing if they do not accept their placement in TCP. As a result, a stand-off exists and some inmates continue to linger in restrictive housing. The OIG has made several recommendations in the past that would assist NDCS in addressing this conflict.

Modified Operations

For the past few years, NDCS has reacted to incidents in various housing units by placing them under “modified operations.” As a result, movements and privileges in these units are restricted in various ways and to various degrees. When this takes place, these units begin to operate more like a restrictive housing unit than a general population unit. In the past, the OIG has suggested that if a housing unit is placed into a lockdown or other similar status, and meets the definition of a “restrictive housing” unit, then the restrictive housing regulations go into effect after a certain number of days under that status.

Blue Rooms

During the past few years, a “blue room” has been in operation at NCCW. It is a cell that was turned into a room which female inmates can visit during times of stress or agitation. It is based on similar efforts in other states, and is configured so that when the inmates go there they watch videos during which they feel as though they are walking through a nature setting. The room is painted blue, and also has a mural. The furniture was bought by the Warden, and is comfortable and adds to the calming and safe environment. The intent of the room is to calm the person down who is in there. One of the benefits of this is that it could keep the inmate involved from having to enter a restrictive housing setting by giving them some time to calm down and get their emotions under control. It is a positive attribute of the facility and those who led the way on this effort should be commended.

The OIG recommended that these “blue rooms” could be expanded to other facilities throughout the correctional system. NDCS has begun to implement plans to expand the use of “blue rooms” in other facilities.

Programming Needs

The 2018 OIG Annual Report stated that there was limited programming available for inmates in restrictive housing and that most of the programming available are individual programs which may be repeated many times by frequent visitors to restrictive housing. The OIG suggested that consideration should be given by NDCS to reviewing the short term programming that is offered to inmates in order to make it more individualized and effective and that if NDCS is going to continue the practice of placing inmates in restrictive housing for long periods of time, then consideration should be given to providing more intensive programs to this population. NDCS is now providing the Violence Reduction Program (VRP), which is a clinical program required for some inmates in order to be paroled, in restrictive housing in TSCI and NSP. They have also begun to implement other programs in those settings. Although the OIG recommended that clinical programs like VRP be provided if NDCS was going to continue its practice of keeping inmates in restrictive housing for longer periods of time, there is a concern that having these programs could keep someone in that setting longer than necessary. For instance, one inmate knows right now that he will be in the January class of VRP. He wants to take the program. However, NDCS needs to continually review whether or not these programs actually inhibit someone from moving out of restrictive housing.

Serious Mental Illness

A consistent challenge for NDCS is how to treat inmates with a serious mental illness, particularly those who have been placed in restrictive housing. The Legislature passed

Legislative Bill 686 this past session. It bans the placement of individuals with a serious mental illness in a restrictive housing setting beginning on March 1, 2020. This mirrors a recommendation from the Vera report.

Direct Releases from Restrictive Housing

The OIG requested data on direct releases from restrictive housing from NDCS and received data that was quite helpful in understanding this practice. In the most recent fiscal year there were 37 individuals who were released directly from restrictive housing to the community. The OIG reviewed those releases and found that only 13 had been in a restrictive housing setting for more than 30 days prior to release. However, there were three individuals who had been in for 598 days, 607 days and 878 days. Another seven individuals had been in a restrictive housing setting between 126 days and 266 days prior to release.

The OIG also looked at whether or not NDCS was releasing people to a different setting within 30 days of release so that it would look like individuals were not being released directly from a restrictive housing setting. There has been a perception that this practice takes place. The OIG found that this rarely takes place and that many of those who are removed from restrictive housing within those last 30 days had requested protective custody. Only 12 individuals in this category had been in restrictive housing for more than 30 days prior to their being released from restrictive housing. Of those, only four had been in restrictive housing for more than 100 days.

One concern regarding these direct release inmates was that there were several who had not received the clinical programming recommended for them. This may be an issue that NDCS takes a longer look at in order to assess what they can do differently for this population.

TSCI SMU Issues

During the past year there have been a number of issues taking place at the restrictive housing units at TSCI, including staff assaults and doors opening unexpectedly. Staff and inmates have expressed numerous concerns about the situation in those units. Steps have been taken in the units by increasing the number of cameras and changing the way doors are opened. However, there are other concerns that still exist including the ability of inmates to pop open hatches on their cell doors, the race makeup of some units, the continual cancellation or delaying of the very limited out-of-cell recreation time, and the inconsistency of restrictive housing reviews. These are issues that the OIG is currently examining and a report related to the situation there will be released later this year.

Colorado

In April 2019, the OIG visited three correctional facilities with James Davis and Jerall Moreland from the Ombudsman's office and Kasey Moyer and Jason Witmer from the Mental Health Association. Mr. Davis, Ms. Moyer and Mr. Witmer were all members of the External Restrictive Housing Work Group at the time of the visit. The visit took place after the OIG participated in a webinar on changes to restrictive housing practices in Colorado. The OIG reached out to Rick Raemisch, the Executive Director of the Colorado Department of Corrections to learn more about their efforts and was invited to visit Colorado.

The first two facilities visited were the Colorado State Penitentiary (CSP) and the Centennial

Correctional Facility (CCF) in Canon City. CSP is a facility that is primarily a restrictive housing prison. CCF is a facility for inmates with a mental illness. The third facility visited was the Sterling Correctional Center (SCC) near Sterling. SCC is a 2500 inmate facility that has a variety of custody levels, including high risk restrictive housing inmates.

Reform of the restrictive housing system in Colorado was brought about by the leadership of Mr. Raemisch and his predecessor, Tom Clements. Mr. Clements began the reform but was actually murdered by a former restrictive housing inmate at his home. Mr. Raemisch was then hired and continued the efforts that were being made. More details on their reform efforts can be found at <https://www.safealternativestosegregation.org/webinar/rethinking-restrictive-housing-whats-worked-in-colorado/>.

The purpose of the fact-finding visit to Colorado was to gain a better understanding of the extent of their reforms and to learn whether there were lessons to be learned that could apply to Nebraska's restrictive housing system.

Key observations of the group were:

- All inmates were provided at least four hours of out-of-cell time each day, or at least the opportunity for that time. If they chose not to utilize the time it was documented.
- Within the restrictive housing system there were different levels of care/security and inmates promoted through those levels.
- As an inmate promotes or progresses through those levels, they receive more congregate time with other inmates, eventually being in activities with up to 16 individuals.
- It is expected that no one will be in that setting for longer than one year and that during that year an individual will receive at least one cognitive program.
- Inmates at all levels have the opportunity to take classes (even with chrome books and the internet) that cover a variety of subjects.
- Leadership at the facilities shared that it was important to have buy-in from the staff about their restrictive housing efforts and that training for restrictive housing begins early in the training process.
- The mental health facility also has levels to promote to and congregate activities.
- The physical plants at CSP and SCC are more conducive to the out-of-cell congregate activities than at TSCI or NSP in Nebraska.
- Colorado provides extensive reports on their efforts and these reports are available to the public.
- The leadership at all three of the facilities were open and transparent regarding the past and current challenges in their facilities.
- A main theme from the leadership teams were that once the decision was made to commit to reform they needed to instill the correct culture in their facilities, educate and engage the staff and the inmates, and understand that there would be negative occurrences and challenges along the way.

The trip was informative and valuable. The OIG would recommend that NDCS leaders and Legislative leaders make a joint visit to Colorado to learn more about their experiences.⁵⁷

Summary

Restrictive housing is a complex matter. It is necessary to utilize it at times because a correctional agency is charged with the safety and security of the inmates and staff and individuals need to be separated from the general population for those reasons. However, more and more evidence points to the negative impacts on the individuals placed in those settings and there are questions regarding the effectiveness of restrictive housing. Correctional systems across the country are looking more closely at their restrictive housing systems and initiatives in other cities and states. National organizations such as the Vera Institute of Justice are closely studying this subject. While the OIG has concerns about the length of time that individuals are placed in restrictive housing, the reasons for those placements, the lack of interaction within that setting and the impact of that setting on one's health, physical and mental, there is also an understanding that two well-meaning people may have different views on how a restrictive housing unit should operate.

There have been some positive steps taken to improve Nebraska's restrictive housing system. Additional programming and the presence of mental health staff is a strong positive. The review system, at first glance, seems like a thoughtful and sound system, but there are parts of it that are not correctly administered. Bringing peers into the system is a constructive step. Director Frakes' direct involvement in some cases is appreciated.

However, as shared in last year's report, the OIG is concerned about Nebraska's restrictive housing system. The role of the Intelligence Division in deciding who enters and leaves restrictive housing needs to be better understood. The lack of a pathway out of restrictive housing for many individuals needs to be rectified. Having ten individuals in that setting for over 1000 days is problematic. Many times it seems that individuals who appear to be excellent candidates for removal from restrictive housing are not removed unless the OIG or the Ombudsman's office intervenes. The growth of individuals placed in restrictive housing for more than 180 days was decreased only after the tripling of this increase was made public by the OIG. NDCS has not utilized the statutorily created External Restrictive Housing Work Group in an effective manner and has not consistently followed up on issues raised in those meetings. Staff in these settings can become fatigued and negatively impacted by that environment.⁵⁸ Reviews by facility and central office staff should follow the NDCS regulations and be more meaningful. In this case, a meaningful review "means an impartial review of the relevant facts, opportunity for input by the affected inmate, specification of the reason(s) for the confinement, and a fair opportunity to achieve the desired result."⁵⁹ If more meaningful reviews begin to take place this could be measured by the attendance of inmates at the facility level reviews.

As more is learned about the impact of restrictive housing on the inmates placed there, additional changes in the use of restrictive housing and restrictive housing practices will take place across

⁵⁷ Reports from the Colorado Department of Corrections can be found at <https://www.colorado.gov/pacific/cdoc/departmental-reports-and-statistics>

⁵⁸ Vera has begun researching this important issue - <https://www.vera.org/projects/restrictive-housing-impact-officer-wellbeing>

⁵⁹ Attachment G: August/September 2018 Article from the *Correctional Law Reporter*

the country and in Nebraska. It is important that as changes are made and the system is improved that stakeholders of the system be welcomed to contribute to these changes by NDCS.

CONTRABAND

Contraband in correctional facilities may consist of a number of categories of items, including drugs, weapons and cell phones. Preventing the introduction of and the detecting of these items can assist staff in preventing the illegal use of drugs, the committing of other crimes and various violent activities. Contraband can be used in a number of ways, including as substitute currency within the correctional facility. The sources of contraband can also vary. Items can be thrown over fences, dropped by drones, smuggled in by visitors or staff, created out of items already in the facility, or stolen from the facility.

Over the past two years NDCS has implemented several efforts to reduce the smuggling of contraband into state prisons. These efforts were included in last years' report:

Recently, the NDCS Chief of Operations shared with the OIG some of the efforts made regarding searches. They included:

- *Discussions were conducted at monthly executive level meetings relative to improving basic security practices, including staff searches;*
- *Review of front entrance procedures at the facilities and more attention being provided to ensuring consistent adherence to policy/procedure;*
- *Reconfiguring of the front entrance at LCC;*
- *Reviewing and revising of the list of staff prohibited items;*
- *Rewrite of cell phone policy;*
- *Unannounced staff searches at all facilities by a special team;*
- *New expectations for the number of staff searches that are to be conducted at each facility along with a new recording system of those searches;*
- *More attention given to visitor searches, including the forming of a work group in early 2018 to develop a visitor dress code; and*
- *Specific to visitor searches, procedure assessments/systems checks are routinely conducted to ensure consistency in compliance with policy and procedure.*

Contraband Tracking

In the 2018 OIG Annual Report, it was reported that NDCS did not have a system of tracking contraband items. Since that time, contraband discoveries are included in monthly facility reports. One issue with this data collection is that NDCS has indicated that when large quantities of contraband are found (for example, a soccer ball thrown over a fence may have several phones and drugs) those are turned over to the Nebraska State Patrol. The OIG has requested data from the Nebraska State Patrol regarding the contraband seized and turned over to their agency but has not received it. NDCS has informed the OIG that they do not receive that information either.

Contraband Continues

Despite the efforts described above, contraband is still a significant problem in the correctional system. This was highlighted by Director Frakes recently when discussing the situation at NSP. This was also discussed in an OIG memo to the Judiciary Committee on August 18, 2019.⁶⁰ However, it varies from facility to facility. Currently, K2 is a significant issue at CCC-L and

⁶⁰ Attachment H: August 18, 2019 OIG Memo to Judiciary Committee

NSP. Illegal alcohol seems more prevalent at NSP and TSCI. Weapons are more of an issue at TSCI and NSP. Cell phones are found more often at NSP. Some facilities have little problem with contraband. LCC seemed somewhat immune to contraband (at least compared to NSP and TSCI) but recent reports seem to indicate an increase in K2 and cell phones.

On August 24, 2019 NDCS issued a press release stating that NSP had been placed on modified operations due to two incidents. The first was a serious inmate assault. The second was 11 inmates being treated for being under the influence of K2.⁶¹ Earlier in the month there was a day with at least 15 inmates treated for being under the influence of K2. This was not reported to the media and the facility was not placed on modified operations. The number of incidents with K2 is quite high at NSP and the OIG is attempting to gain a better handle on the depth of the problem.

There have been recent news accounts regarding staff or visitors who have been caught bringing in contraband. The OIG is also reviewing this information on a regular basis, as well as reviewing what cases are being referred to either the local county attorney or the Nebraska State Patrol.

Other Solutions?

In the past, the OIG asked NDCS staff through surveys for ideas on reducing contraband. These suggestions were provided to NDCS. However, new attempts at negating the flow of contraband may be necessary.

A recent review of search records at one facility found that there was not a lot of variance regarding the timing of the staff searches. It may be more effective to vary the times of the searches in facilities that are not doing that already. One individual suggested that all incoming deliveries to a facility be run through one building on the periphery of the facility. This would include such things as laundry, canteen, kitchen necessities, etc. Dedicated search staff would go through everything coming into the facility. The monitoring of searches of staff, visitors and items at each entry to a facility could be increased and the review times could be varied as well.

Reducing demand for contraband can also assist in impacting the flow of contraband, especially drugs. The 2018 OIG Annual Report discussed having immediate interventions for those found using drugs such as K2. This, along with providing substance abuse treatment earlier in an inmate's sentence, are steps that could be taken to assist with reducing demand.

Surveying staff and inmates on how best to reduce the flow and usage of contraband would likely reveal some interesting and thoughtful suggestions.

⁶¹ Attachment I: August 24, 2019 NDCS Press Release

DEATHS AT NDCS

Each year there are a number of deaths that take place at NDCS. The OIG is required to review these deaths and the circumstances surrounding them. NDCS promptly shares information with the OIG when an inmate dies and provides any reports, videos or other documents regarding the death when requested by the OIG. As a result all deaths of inmates in the custody of NDCS were appropriately reviewed during the past year by the OIG.

Suicides

So far in 2019, two inmates have committed suicide while residing in a correctional facility. After both suicides, the OIG reviewed pertinent information and video related to the suicide, including utilizing the NDCS Internal Critical Incident Report (ICIR) that were completed for each suicide. These suicides, as well as information on attempted suicides and suicide data, will be shared in a separate report later this year.

2016 Suicide Follow-up

In 2016 there was a suicide in the restrictive housing unit at TSCI. An ICIR was completed for that suicide (the OIG was invited to participate in that ICIR and was a member of the ICIR team). The ICIR made many recommendations, some of them are similar to the ones related to a 2018 suicide. Last year, some of these recommendations and the action that was actually taken after that are found in the following table:

TABLE 2

RECOMMENDATION	ACTION/RESPONSE BY NDCS
Consideration should be given to installing audio recording capabilities in the SMU galleries.	This is not fiscally feasible at this time.
Additional video surveillance cameras at the opposite ends of the SMU galleries should be installed.	This will continually be reviewed as new upgrades continue.
After a traumatic event, Mental Health/Victim Assistance contacts should be scheduled during the shifts that the involved staff work.	TSCI has been using our own staff for this purpose...
The Johnson County Emergency Responders (911) were not called for 7 minutes after the initial report. Correctional staff should be trained to recognize acute injury or illness that requires lifesaving emergency care and to immediately notify 911.	Staff are trained about emergency procedures during in-service, pre-service, SMU and OJT training.
A security assessment should be completed to evaluate the adequacy of the night lighting in each cell.	It was determined that night-lighting is sufficient. Staff can supplement night-lighting with flashlights when needed.
Remove the second bunk and cabinet from all SMU cells.	This will not be done. Double bunks will stay in SMU at the present time. ⁶²
Feedback from the attendees of a...debriefing...recommended additional training with an adult size/weight faux inmate to use the hook knife and practice the safe method to sever the noose while concurrently assisting the inmate to the ground.	TSCI does possess these...AIII Ilic is going to plug this into In-Service beginning July 1, 2017.
TSCI Administrators should request to pilot Electronic Time Check Cell Observation technology to replace hand written observations of 30 minute checks.	Per Cpt Morris he has received information that although he submitted a proposal for electronic cell checks at TSCI, Central Office is looking into a more

⁶² The inmate who committed suicide in 2016 in SMU hung himself from the upper cabinet just like the inmate who committed suicide on April 28, 2018.

	comprehensive electronic cell check logging system Department-wide...Although this is not fiscally viable at this time, it will be considered when the budget improves.
--	---

Since last year, some of those recommendations have been acted upon. NDCS recently contracted for electronic cell check technology that will be used in the restrictive housing units at TSCI and additional cameras were installed (as a result of other incidents) in the units.

Suicide Work Group Efforts

As reported in the 2018 OIG Annual Report, after two suicides and multiple suicide attempts in 2018, NDCS established a work group to look at suicides. The OIG was asked to participate and became an active member of the work group. The work group met several times and made several recommendations. The following recommendations were made with the intent of implementing them last year:

- Creating a brochure on suicide that will be distributed to inmates and in visiting areas for friends and family;
- Making changes to the staff training manual;
- Streaming a suicide prevention video in all facilities;
- Utilizing an additional screening tool at transfer times and intake; and
- Advertising a telephone number that people can call when they are concerned about a loved one who is in a state correctional facility so that staff can initiate action related to the contents of the call.

There were several other excellent ideas discussed but it was decided that these were the ones that should be addressed at the current time. The work group took their work seriously and their work product was excellent. However, the OIG is in the process of investigating suicides in 2019 and was informed by NDCS that only one of these changes was implemented – the establishment of a telephone number to call for people concerned about their friends or family members. The OIG actually tried calling the number and did not always reach a live person. This was relayed to NDCS and was resolved. The OIG tried it again after this and reached a live person. The OIG will test it again prior to the release of the investigatory report on the 2019 suicides.

VOCATIONAL/EDUCATION

In 2017, the LR 127 Committee report included the following two statements:

The Department and the Legislature should work together to increase opportunities for inmates to acquire vocational or other skills during incarceration that will help ensure their success upon reentry to the community.

The LR 127 Committee believes that the desire expressed by inmates for more work and vocational skills opportunities should be pursued. There is reason to believe that increasing such opportunities will assist in both managing the inmate population, and in preparing inmates for a successful return to the community. Both of these outcomes are essential to the success of Nebraska's justice system.⁶³

The OIG remains in agreement with these statements. The only change that has been observed regarding this has been some slight changes due to the grants provided through the Vocational and Life Skills Grant Program. Several ideas and suggestions have been shared regarding this in the past, including the following suggestions from last year's OIG report:

When visiting correctional facilities the OIG meets a number of incarcerated individuals who have many ideas on how to improve the correctional system. One such individual is David W. He has been in the correctional system for a number of years, but has put his time in prison to good use. He is aware of a number of initiatives that have taken place in other states, and has shared those with the OIG. One of these initiatives is The Last Mile project in San Quentin State Prison in California.⁶⁴ The program trains inmates in the technological arena so that they can build skills that are needed when they return to society. In 2014, The Last Mile started an inclusive computer coding curriculum so that participants can learn how to become computer programmers. According to The Last Mile there is anticipated to be a shortage of over one million software engineers by 2020. They overcame the challenge of not having the internet in their facility by creating a programming platform that simulates a live coding experience. The Last Mile continues to expand their curriculum and has branched out to other correctional facilities in California. San Quentin is also the home of the San Quentin Prison University Project which received a National Humanities Medal in 2015 for their work educating inmates. A RAND Corporation study showed that "inmates who took classes had a 43 percent lower likelihood of recidivism and a 13 percent higher likelihood of getting a job after leaving prison."⁶⁵

Another initiative the inmate shared with the OIG is the Hudson Link program. This program provides college education, life skills and re-entry support in New York and in the past 20 years has awarded over 600 degrees utilizing nine colleges. It is located in six correctional facilities in the State of New York. The recidivism rate for those who go

⁶³ https://nebraskalegislature.gov/pdf/reports/committee/select_special/cso/2017_lr127.pdf (pages 27-28)

⁶⁴ <https://thelastmile.org/>

⁶⁵ "Turn Prisons Into Colleges." New York Times. March 7, 2018

through this program is less than two percent and the cost of the program is approximately \$5000 annually per inmate.⁶⁶

One suggestion provided to the OIG was for the Legislature to create an Education and Employment Work Group. The Work Group would consist of NDCS staff, but more importantly, representatives of the Nebraska Department of Labor, businesses community, higher education (especially community colleges), formerly incarcerated individuals, reentry organizations and others interested in these areas. The Work Group would then be assigned tasks, including the assessing of the current state of education and employment training within NDCS, reviewing leading edge efforts happening in other states and making recommendations to the Governor and the Legislature by the end of 2019. An example of this effort that should be reviewed is the work of Senator Dwite Pedersen in 1991. Senator Pedersen, along with Senator John Lindsay, introduced Legislative Resolution 477 that year and convened a group of stakeholders that reviewed the activities of the Correctional Industries program within NDCS and conducted a number of analyses of the program and related issues. The OIG would urge those interested in this area to review the LR 477 Report.⁶⁷

Another idea comes from former Governor Tommy Thompson of Wisconsin. Earlier this year, Governor Thompson put forward a proposal to create a “Second Chance Skills Institute” in Wisconsin by converting a prison (or possibly building a new one) into a job and skills training facility for future parolees. The Institute would work with state government, employers, unions, businesses and others to identify needed skills and to provide instruction and support. Governor Thompson wrote an article on his idea and one the more interesting quotes from the article was this, “Looking back, I regret not spending more time considering, ‘What does tomorrow look like for that parolee, and can we work together to help provide the necessary tools to reap a new opportunity.’”⁶⁸ One possible location for such an institute could be the conversion of the 600 minimum beds at NSP. These overcrowded dormitories which were supposed to be temporary housing decades ago could be “right-sized” and made into a specialized unit that inmates would strive to enter. Other possibilities could be to convert part of OCC into such a facility or build a stand-alone facility in either Douglas, Lancaster or Sarpy Counties. If a stand-alone facility were to be built it could end up being a facility that is actually two facilities in one. One part could be the job and skills training institute and the other part could be a therapeutic facility in which clinical programming could be delivered in a therapeutic setting to minimum custody inmates before their parole eligibility date. Should this be considered by policy makers there would be a number of options available to move forward on this proposal.

⁶⁶ <http://www.hudsonlink.org/>

⁶⁷ LR 477 Report

⁶⁸ “Tommy Thompson: Help solve Wisconsin’s coming labor shortage by rehabilitating prisoners”

UPDATE ON ASSESSMENT TOOLS

Over the past few years, NDCS has undertaken two different projects to attempt to improve its assessments of inmates. The Department's classification tool is designed to determine an inmate's custody level, and the STRONG-R is a risk assessment instrument.

Classification Tool

The purpose of a classification tool is to match the needs of an inmate with the resources in a correctional facility. As a result of the use of the tool, an inmate is classified at a particular level, which may be community custody, minimum custody, medium custody or maximum custody. At various times, the tool can be utilized to determine whether or not an inmate's appropriate classification has changed. A new classification tool was developed for NDCS and implemented in 2017.⁶⁹

The purpose of this new tool was twofold. First, they needed a more accurate tool because the previous tool had so many overrides and was so outdated that it was not accurate any longer. Second, a new tool, as explained by Director Frakes, would give them important data that would show what their future needs were when it came to the construction of any new beds.

In that 2016 legislative hearing, Director Frakes said the following about the new tool and the data shared above:

I've also brought in...I put an internal team together to re...I won't say redesign but to update our classification tool. Then we've contracted with UNO to validate that tool. Then we will train our staff and apply that to our population so that we can get a much cleaner assessment of the makeup. As today, actually, seems like the time to hand this out. (Exhibit 3) This is not to scale. That's a disclaimer. It's just a nice visual representation. So based on our current classification tool today, 31 percent of our population lands at max custody, about 30 percent at medium custody, about 28 percent at minimum, and 11 percent at community. Part of what we know is that the community population is very much driven by bed space. You can't get community custody until a bed is available for you to go into it. After we apply, after we get the tool validated and apply it, my hope is that we land in a distribution that's much closer to the pyramid triangle on the right-hand side. About 15 percent of the population should fall at maximum custody, about 35 percent in medium, 35 percent in minimum, and at least 15 percent in community. Without that information, today I know, based on the data we have, that we can support another 160 community custody beds, so I felt very comfortable asking for that funding. But until I get a better assessment and get a true understanding of the makeup, I can't tell you today what additional beds should or shouldn't be built without doing this. And I said I'm not going to do that.

In 2017, the Department provided the OIG with data regarding the implementation of the new classification tool. The initial results showed a dramatic change in custody classifications for the male population (significant shift to community custody classification). These results were

⁶⁹ <https://www.unomaha.edu/college-of-public-affairs-and-community-service/nebraska-center-for-justice-research/documents/hamilton-kigerl-ndcs-classification-final-report-2016.pdf>

reviewed by a committee and the results were revised by the committee. The results of the two results are in the table below.

TABLE 3

	Initial	Reviewed
Maximum	3.50%	1.70%
Medium	8.80%	11%
Minimum	2.30%	20%
Community (including Minimum 3B)	85%	66%

Last year, the OIG stated, *“It is imperative that NDCS continue to work with this classification tool in an attempt to improve it and have it become more accurate and better understood.”* As a result, the OIG requested updates on the results of this tool during the past year and the data was difficult to obtain. During the past few months the OIG has met with NDCS staff to learn more about the tool, reviewed a number of cases regarding the tool and also discussed with inmates their experience and perception of the tool. It is the understanding of the OIG that the tool is being modified due to concerns with the results of the tool. A main concern expressed regarding the tool is the inability of the tool to capture an accurate and complete picture of the inmate.

In his 2016 testimony that was shared previously, Director Frakes said this, *“But until I get a better assessment and get a true understanding of the makeup, I can't tell you today what additional beds should or shouldn't be built without doing this.”* Three years later NDCS does not have the information that Director Frakes said he needed to make decisions on the types of beds the NDCS system needs. Since that time, the Legislature has approved 100 minimum beds at NSP and 384 high security beds at LCC.

One additional concern that seems to be an increasing issue is the role of the central office in determining the actual placement of an individual after they have been assessed by the classification tool. The Ombudsman’s office and the OIG have seen a substantial increase in cases from inmates who object to their final classification status that is determined by a team in the central office. Along with that, there have been a significant number of complaints regarding the length of time for an appeal of that decision to be completed. These are two issues that will continue to be monitored by the OIG in order to determine if additional action needs to be initiated.

NDCS has stressed that they are continuing to address the concerns that exist regarding the classification tool and the OIG will be receiving an update on these efforts in October from the Deputy Director of Programs.

STRONG-R

On July 1, 2016 NDCS began to implement a new risk and needs tool for their population called the STRONG-R (Static Risk and Offender Needs Guide – Revised). The STRONG-R is an actuarial risk assessment tool that is used to predict recidivism, determine custody levels, and determine the needs of inmates coming into the correctional system. The tool was originally

utilized by NDCS and Parole but due to concerns about the usefulness of the tool Parole selected a different tool, the ORAS (Ohio Risk Assessment System).

The contract for the STRONG-R originally established that it would run through December 27, 2018, and that Vant4ge would be paid \$476,200. The contract was amended by NDCS and the cost of the total contract increased to \$621,032 according the Department of Administrative Services.⁷⁰ In the 2018 OIG Annual Report, it was shared that the OIG contacted NDCS in August 2018 to seek more information regarding the upcoming Request for Proposal, and was informed that they had not made any decision to step away from Vant4ge and that the contract has two three-year renewal options available.⁷¹ Therefore, this contract had the potential to not be put out for bid at that time. On August 29, 2018 the OIG sent a letter to Director Frakes asking him to consider issuing an RFP for several reasons. He indicated that he appreciated the recommendation by the OIG, and that they are considering all of their options.

NDCS extended the contract for six months in December 2018 at a cost of \$37,500⁷² and recently renewed the contract for three more years for a total cost \$529,600.⁷³

⁷⁰ <https://statecontracts.nebraska.gov/Search/Index>

⁷¹ Attachment J: Letter from the OIG to NDCS regarding the Vant4ge contract

⁷² Attachment K: NDCS contract extension with Vant4ge

⁷³ Attachment L: NDCS contract renewal document with Vant4ge

ESCAPE UPDATES

McCook Work Ethic Camp Escapes

Last August, there were two escapes from the Work Ethic Camp (WEC) in McCook. The details regarding those escapes were shared in the 2018 OIG Annual Report. After the escapes, the OIG found two obvious concerns regarding these two escapes. First, the wire on top of most of the fence surrounding WEC was a few strands of barbed wire instead of razor wire. It was found that WEC had requested adding razor wire in the past but those requests had been denied by NDCS. There is now razor wire on the fence. Second, one of the escapes was not captured on video due to a significant blind spot that was not covered by the institutional camera. This has been addressed as well by WEC leadership.

Community Corrections Escapes

Over the past few years there has been more attention paid to individuals who reside in the community corrections centers in Omaha and Lincoln who either don't return from work release or leave the facility and do not return. As this became more of an issue the OIG recommended to NDCS that they notify the OIG and the public regarding these escapes. Public notification brings attention to their escapes and also can gain assistance from the public as their return to custody is sought. This goes along with the existing practice of law enforcement notification. NDCS implemented this recommendation. In most cases, the individual returns or is caught by authorities. The OIG has reviewed many of these cases and found that the circumstances behind each one can be quite varied. Sometimes individuals are in the community and take some action, such as drinking or using drugs that they know will get them in trouble. They then do not report which actually creates additional difficulties for them. Other individuals decide that they just want to leave and return to their previous life. Others have various reasons for why they decide to escape from custody. In many of these cases, the individuals are charged with escape and receive an additional sentence. Recently, one inmate set up a plan to leave. He carried it out despite being about a month away from being fully released. Unfortunately, this wasn't the first time that someone acted like that in Nebraska's system.

PROGRAMS

As shared in previous OIG reports, programming is a key part of the correctional experience and can have a major influence on overpopulation. The programming at NDCS can be divided into three categories: clinical, non-clinical and other.

Clinical programming is provided by a trained clinician and focuses on three main areas: violence/anger, substance abuse and sexual offender treatment. The two clinical programs that are currently being provided in NDCS for violence/anger are: (1) the Violence Reduction Program, and (2) Anger Management. The two clinical programs that are currently being provided in NDCS for substance abuse are residential and non-residential substance abuse treatment programs. The two clinical programs that are currently being provided in NDCS for sexual offenders are iHelp (inpatient) and oHelp (outpatient).

Non-clinical programming does not need to be provided by a trained clinician, but those that do provide it must have received the appropriate training. The two most significant non-clinical programs currently being provided at NDCS are Moral Reconciliation Therapy (MRT)⁷⁴ and Thinking for a Change (T4C).⁷⁵ These are both evidence-based cognitive behavioral programs that generally assist individuals in making better decisions. These programs are not required by the Board of Parole in order to qualify for parole but they are recommended by NDCS, primarily through the use of the STRONG-R.

Programming can not only help to provide inmates with what they need to make better life choices, but it can also assist a housing unit, facility or correctional system in operating in a more safe and efficient manner. If inmates receive programming that assists them with making better decisions, then it impacts those around them, which then impacts a facility and eventually a correctional system.

Programming can also influence the number of inmates in the correctional system. Many times an inmate will not be paroled if they need certain clinical programming and they have yet to receive it. In addition, some programs can assist inmates in changing their behavior so that they will make better decisions, and receive fewer misconduct reports, which can also impact their good time. There are times when an inmate is recommended for a clinical program in order to be paroled, but is not allowed to participate in that programming due to their behavior. The OIG has reviewed a number of cases where an inmate, who has been recommended for the Violence Reduction Program or Anger Management, acts out in a violent or angry way. Due to this behavior they are then not allowed into the program, even though that program may possibly assist them with changing that behavior.

During the past year or longer the OIG has witnessed improvements in the expansion of the violence related programs as well as a decrease in the wait for sex offender assessments and programming. These are positive improvements.

⁷⁴ <https://www.ccimrt.com/>

⁷⁵ <https://nicic.gov/thinking-for-a-change>

Data

In 2017, the OIG met with NDCS staff and an arrangement was made so that NDCS would provide the OIG with average population data for program participation on a quarterly basis for 18 different programs. This was in conjunction with NDCS efforts to continually track some of this data in an electronic database. The OIG received the first quarterly report from NDCS on March 29, 2017, and NDCS is now including this data in the NDCS quarterly data sheets that are produced by NDCS after an arrangement was made between NDCS, the OIG and Senator John McCollister. Instead of recreating the data for this report, it is attached as a document to the report for the review of the reader.⁷⁶

Areas of Concern

Earlier this year, it was learned that the inpatient sex offender program at LCC will be moved to OCC in January 2020. The OIG and the Ombudsman's office have worked jointly to gain a better understanding of this decision after being contacted by individuals concerned about the move to OCC. Some initial concerns include, but are not limited to:

- Safety for the program participants on the open yard at OCC;
- Possibility that placing the program at OCC disrupts the needed flow of inmates into and through a minimum custody facility;
- Loss of staff if the program moves from Lincoln to Omaha; and
- Housing program participants in a unit that has eight people living together in a cell rather than two people living together in a cell.

The review of this move is still being assessed by both offices.

As shared previously, currently inmates that enter NDCS have their needs assessed. One recommendation that could result from this assessment is the need for domestic violence programming. NDCS used to provide this program but they no longer do. Instead, inmates with a need for this program are not able to participate in a domestic violence program until they are paroled, and only then if it is a condition of their parole, or participating in work release. Inmates with this identified need who "jam" their sentence do not have to take it once they are released. Parole does offer domestic violence programming in both their Omaha and Lincoln offices. These classes have room for 12 students at a time. If an individual wishes to take it in the community through a community provider it can last up to 36 weeks and the cost is between \$60 and \$100 per session. In June 2019 approximately 600 inmates in NDCS custody had been recommended for domestic violence programming. For community safety reasons, NDCS should consider re-starting this program.

Substance Abuse Program

One of the most important clinical programs in the correctional system is the substance abuse treatment program. Concerns have been expressed to the OIG about the type of programming being provided and how it does not meet the needs of the individuals that go through the program. Prior to the submission of this report, the OIG met with Director Frakes to go over the potential contents of the report. Upon expressing concern about the state of the substance abuse

⁷⁶ Attachment M: NDCS Quarterly Data Sheet, April-June 2019

treatment program and the need to update it, Director Frakes shared that NDCS was reviewing the program and would be assessing its effectiveness. This is very encouraging. As part of this review, the OIG would recommend that NDCS include community treatment providers in the discussion as relationships between NDCS and community providers could be very effective. The review should also examine any issues with attracting and retaining staff for the program and share any findings and recommendations to Director Frakes.

Staffing

Since 2016, the Division of Behavioral Health has improved their staffing levels. Supervisory and psychologist positions are consistently filled but there are still challenges in recruiting and retaining mental health therapists, substance abuse counselors and support staff. This was also identified as a challenge in the Retention Work Group report. Future needs could include additional staff for the sex offender programs, additional substance abuse counselors to expand the delivery of treatment and additional positions at NCCW due to the high rate of mental illness in the female population. Consideration should also be given to expanding substance abuse treatment staff to the community corrections centers to assist inmates who relapse while on work detail or work release. Staff would also be assisted if there were additional programming and office space as those types of spaces are a challenge throughout the system.

Clubs/Social Groups/Non-NDCS Programs

There are a number of other groups that meet within NDCS facilities that are not considered to be NDCS programs. However, many of them have a significant value to institutional life and culture, and are desired by the inmate population. Some are groups begun by the inmates themselves, and others may be run by volunteers or other groups from outside the facilities. There are many examples of positive events taking place that have the purpose of providing supports, guidance or some type of skill to those willing to participate.

For decades there have been a number of social groups or inmate clubs that meet on a regular basis at the facilities. However, according to veteran inmates, these opportunities have declined over the years due to changes in yard practices and security measures. There are a number of these veteran inmates who have shared with the OIG the positive impact that these have had on their lives and they would like to see an increase in these opportunities in the future. The OIG plans to attend more meetings of these clubs in the next year, especially after attending a particularly thought-provoking meeting of the Harambee Club at OCC earlier this year.

COMMUNITY CORRECTIONS

NDCS has two facilities designed to house inmates who are eligible to work outside the NDCS facilities, the Community Corrections Center-Lincoln (CCC-L) and the Community Corrections Center-Omaha (CCC-O). Until recently, these two facilities housed both male and female inmates.

Expansion

In September 2017, CCC-L expanded by 100 male beds when a dormitory style housing unit was opened. This was funded by legislative action in 2016 at a cost of approximately \$1.8 million. Male inmates reside in their housing unit and it primarily consists of men who are near their release date and are on work detail.⁷⁷ A 160-bed female unit at CCC-L was opened earlier this year. This unit is a separate building that includes a separate food service unit, an expanded canteen and additional offices and program space. In the past month, NDCS closed the 20 female beds at CCC-O, which will allow CCC-O to expand their male population by the same number. In addition, the previous female unit at CCC-L converted to a male unit which resulted in an expansion of male beds at CCC-L by approximately 84 beds. This project cost slightly more than \$20 million. The new female unit at CCC-L is a modern facility that will serve this population well. However, past population projections have indicated that many of these community custody beds will be empty due to there not being a need for 160 female community custody beds. Should these 160 beds be filled, it is likely that NDCS will have changed how they classify female inmates and there will be a valid concern about the readiness of the women sent to that unit.

As stated in past OIG reports, the OIG still has concerns regarding the elimination of female community custody beds in Omaha. According to NDCS data, over 34% of the women in Nebraska's correctional system are from the metro Omaha area and the closing of these beds will not allow these women to begin the transition process from prison and back into society in their home community. When they are discharged from CCC-L they will then have to restart the employment process when they move to Omaha. In contrast, if they were able to serve the end of their sentence in Omaha, then they would be able to rebuild relationships with their children, who many are expected to parent once they are released, and find other supports such as housing, treatment options, employment and education.

Other Community Custody Options/Innovative Ideas

In the past, the OIG presented information to Director Frakes and the Legislature regarding other options for inmates who have been classified as community custody and are eligible for work release opportunities. This information has been included in past reports and in testimony before the Legislature. A group of stakeholders is currently meeting as a result of the introduction of Legislative Resolution 223 and they will be looking at various options for the future of NDCS, especially in the area of community corrections. The Sherwood Foundation in Omaha has convened a group for about three years of a number of stakeholders and they are working on the issue of re-entry which also impacts community custody options and other areas of release and

⁷⁷ Work release is when an inmate works in the community for a private employer. When someone is on work detail they pay \$12/day to NDCS for rent. Work detail inmates receive a very small wage from NDCS for their work within the facility or for another state agency.

treatment. The OIG served on this committee until earlier this year. Nothing should be off the table as these discussions take place.

Last November, the OIG sent a letter to Lt. Governor Mike Foley and Senator Anna Wishart due to their interest in the rehabilitation of those in the correctional system. The letter shared a suggestion that was provided by one of the Vocational and Life Skills Program grant recipients regarding the establishing of a state policy to encourage the hiring of previously incarcerated individuals. Examples from New York and North Carolina were shared with these two policy makers that had been quite successful at encouraging employers (government and private) to consider formerly incarcerated individuals for jobs. These are programs with very little cost but that can help remove the stigma from formerly incarcerated individuals and assist with their successful return to their community.⁷⁸

Re-Entry Services

The Vocational and Life Skills Program was established by the Legislature in 2014. It is a grant program that contracts with community groups to provide reentry services for individuals who are about to leave or have left the custody of NDCS. The first grant cycle began in early 2015, and the second began on July 1, 2016. The third grant cycle began on July 1, 2018.

Approximately \$7 million is provided to grant recipients during the two year grant cycle. The grant recipients are offering services in areas throughout Nebraska, including a combination of programs, such as housing, employment services, education, and vocational training. In addition, more services are being provided within the correctional facilities by these groups. To give the reader a better idea about the work of these grant recipients some of these groups have provided information to the OIG regarding their efforts. These are included as attachments to this report.⁷⁹ NDCS also publishes quarterly reports on this program.⁸⁰

As part of the NDCS reentry effort, NDCS reentry specialists meet with inmates at least three times during their incarceration. These include contacts during the beginning, middle and end of their sentences. The purpose is to work with the inmates to establish a reentry plan. Parole has also created its own reentry positions that go into the correctional facilities to work with inmates that are about to be paroled.

⁷⁸ Attachment N: November 11, 2018 letter from the OIG to Lt. Governor Foley and Senator Wishart

⁷⁹ Attachment O: VLS Grant Information Summaries

⁸⁰ The most recent VLS report can be found at https://nebraskalegislature.gov/FloorDocs/106/PDF/Agencies/Correctional_Services_Department_of/490_20190722-134727.pdf.

COUNTY JAIL PROGRAM

NDCS continues to contract with a number of county jails to house state inmates. NDCS pays a contracted rate to each county jail for each inmate housed there, and the sole purpose of this program was to assist with the overpopulation issue. Although NDCS previously announced that the program would end on June 30, 2017, it did not, in fact, end as planned. NDCS has not requested funding for this program after June 30, 2017 but instead uses other correctional funds from other sources for this purpose. NDCS suggested to the OIG in the past that they hoped to end the use of this program when the new housing unit was opened at CCC-L but this only slightly impacted the population in the county jail program.

In 2018, the OIG met with county jail staff and the state inmates who resided in most of the county jails that maintain contracts with the state. Concerns were shared with the OIG and these were shared with NDCS. Earlier this year, the OIG visited three of the county jails and was told that after the information was shared with NDCS that several improvements took place.

Throughout the history of the program, NDCS has indicated that they would like to send inmates to these jails who have recently entered the custody of NDCS. Many times it has been stated by NDCS that the intent is to keep the inmates there for approximately 90 days before returning them to a state correctional facility. Earlier this year there were cases brought to the attention of the OIG regarding inmates who had been there for periods longer than 90 days. This was brought to the attention of NDCS and several inmates were moved as a result of this notification. There are some inmates who wish to remain in the county jail and have volunteered to stay past 90 days. However, there were others who were not moved despite the efforts of the OIG. NDCS was resistant to these transfers and indicated that the inmates had not requested to move. The OIG contacted the county jail and found out that they had been requesting such moves for at least two months. NDCS eventually agreed that this was the case and moved those individuals into a state correctional facility. Recently, another case of someone who has been in the county jail for over 180 days was brought to the attention of the OIG. This was shared with NDCS and they indicated that his transfer had been scheduled and he was actually transferred to NSP the next day. When inmates are sent to the county jails (and many are resistant to such moves) they have typically been told that they will be there no longer than 90 days. The OIG has confirmed this in the past with county jail staff, NDCS staff and the inmates. It is important that NDCS monitor the lengths of stays at county jails so that individuals do not exceed this established placement goal.

INMATE LETTERS

During the past four years, the OIG has received numerous letters from inmates in the state's correctional system. They come from all facilities and cover a multitude of issues. The OIG has improved the responsiveness to these letters during the past year. However, the letters and cases opened as a result of those letters, has increased during the past year. In 2018, there were 162 cases opened as a result of a letter from an NDCS inmate. So far in 2019 there have been 164 cases opened as a result of a letter from an NDCS inmate. This does not take into account the number of issues looked into by the OIG after being approached by inmates during one of the numerous visits to correctional facilities.

The letters are valuable in that they provide information on issues within the correctional system. At times the OIG will refer the inmate to the Ombudsman's office, but ask that person to keep them updated on their situation. The challenge of responding to all of them in a timely manner will always exist but it is important that if someone contacts the OIG that they should then receive a response.

Some of the more interesting letters are ones that provide insight and then suggestions on how to improve the justice system. Innovative ideas arrive all the time in the mail and are also shared with the OIG while visiting facilities. For example, a group of inmates sentenced to life sent a proposal to the OIG and senators regarding individuals with life sentences. They drafted a potential piece of legislation called the Fair Act Treatment Proposal. It is their proposal to set up a mechanism for those sentenced to life to be given another chance after they have served a significant number of years and have completed all of their recommended programs. It is a thought provoking letter and proposal.⁸¹

⁸¹ Attachment P: July 15, 2019 letter and proposal from Crescent Willie Tucker

ISDP (Inmates Sentenced to the Death Penalty) CONCERNS

A group of inmates who are on death row contacted the OIG to express concerns regarding their living conditions. The OIG met with half of the inmates on death row at TSCI after receiving their request. They voiced concerns about their living conditions including:

- Being split into two groups and the impact that this has on their out-of-cell time;
- Their outdoor recreation area is dissimilar from the general population yard including the fact that they do not have weight machines;
- Cells in their unit were stripped out so that would have other uses but those were not completed;
- Due to their being in the Special Management Unit with restrictive housing inmates when there is no movement in that unit due to actions of those inmates they are impacted and have their movement restricted, including no access to their own yards;⁸²
- Being housed in that type of unit has an impact on their mental health conditions;
- The rule book for ISDP is not consistent with the post orders for that unit; and
- Law library access has decreased.

It was a productive meeting and the OIG forwarded these concerns to the appropriate NDCS executives for their review. The OIG recently asked the Deputy Director of Prisons if any of these concerns have been addressed or will be addressed.

⁸² In addition to an outdoor yard for congregate activities, each cell opens up to a private space that has an exterior opening.

NDCS STRATEGIC PLANS

In October 2015, NDCS released their first strategic plan for 2015-2017.⁸³ This was an eight page document that is required by state law that was passed in 2015, that required NDCS to utilize a strategic planning process for future budget requests. In this plan, NDCS named five “Leading Goals” and had outcomes, strategies and measurements associated with each of those goals. The plan discussed evidence based practices, operational capacity versus design capacity, behavioral health needs and a capital construction six year plan. The plan did indicate that changes would be made to CCC-L to add female beds and to revise the core services. This has been accomplished. It also discussed the LCC/DEC Regional Treatment Center proposal. A portion of this was funded and it is still moving forward. The rest of the report discussed the six year plan for FY2018-2021. The table below has the plans and the status of those plans.

TABLE 4

Future Consideration, FY 2018-2021	STATUS
WEC: Add 100 minimum beds at WEC and reduce the dormitory capacity to 160 beds (from 200). Increase core services to support an operating capacity of 260 minimum custody beds.	No progress.
NCCW: Consider separate housing for female juvenile inmates. Increase core services to support an operating capacity of 360 beds, all custody levels	No progress.
NSP: Consider reduction of existing dormitory capacity from 600 to 480 beds, as well as the addition of 120 minimum custody beds. Replace existing segregation unit with a functional Restrictive Housing Unit that includes programming space. Increase core services to support an operating capacity of 1350 beds.	100 minimum beds are being added to NSP but it is not clear if those will reduce the current dormitory capacity due to overcrowding. Segregation unit is still in operation and core services have not been changed.
CCC-O: Site could support an additional 100 male community custody beds. Increase core services to support the increased operating capacity of 250 beds.	No progress.
OCC: Expand and improve core services to support an operating capacity of 792 beds.	No progress.
TSCI: Potential for addition of 100 new maximum custody beds if the overall population custody levels warrant the need for higher custody beds.	This was attempted by double bunking a portion of the Special Management Unit and designating it as General Population. Eventually, these units were changed to restrictive housing units.
Provide space for parole hearings, parolee services, Parole Administration, and the Parole Board adjacent to the largest NDCS community reentry center, CCC-L.	Parole Administration moved to their own location.

⁸³ https://www.corrections.nebraska.gov/sites/default/files/files/39/ndcs_strategic_plan_2015.pdf

In 2016 a Progress Summary was released regarding the 2015 plan.⁸⁴ It contained additional information and updates of the previous plan. It also revealed that each “Leading Goal” would include three outcome measures that would be metric documents that provide snapshots of the status of outcomes and goal completions.

In September 2016 another strategic plan for 2015-2018 was released but it was nearly identical to the first strategic plan.⁸⁵

In October 2017 the NDCS Strategic Plan Progress Report for Fiscal Year 2016-2017 was released.⁸⁶ The plan contained data on the Violence Reduction Program, the Vocational and Life Skills Program, mission specific housing beds, and restrictive housing population and general information on non-clinical programs and other NDCS initiatives. It did not include any information or updates on the six year capital construction plan or many specifics regarding 33 measurements related to the “Leading Goals” mentioned in the first two plans.

In September 2018 the 2019-2023 Strategic Plan was released by NDCS.⁸⁷ The plan shared planned outcomes of NDCS. Many outcomes are listed in the plan, including that NDCS will reduce the number of workplace injuries by 50%, that one-third of process improvement projects will originate from QDIP boards, that 100% of NDCS team members will achieve 3.2 or higher on performance evaluations, and that agency turnover will be reduced to 18%. However, in many cases there are little specifics on how these outcomes will be achieved. For example, the plan shares that in the most recent calendar year the turnover rate was 27.6% and it states that “While total turnover has climbed since CY 2012, the rate of increase has slowed.” It lists strategies that may assist with turnover but some of these, such as reducing mandatory overtime and eliminating staff assaults, are somewhat easy to list but very difficult to enact. Capital construction is discussed in the plan, including future considerations.⁸⁸ It provided updates on the projects currently underway and provides information on the FY 2020-21 NSP core services request and future considerations after that project.⁸⁹ The future projects are listed in the next table.

⁸⁴ https://www.corrections.nebraska.gov/sites/default/files/files/39/strategic_plan_progress_summary_2015-2016.pdf

⁸⁵ https://www.corrections.nebraska.gov/sites/default/files/files/39/ndcs_strategic_plan_2015_-_2018_updated_september_2016.pdf

⁸⁶ https://www.corrections.nebraska.gov/sites/default/files/files/41/fy17_strategic_plan_progress_report_0.pdf

⁸⁷ https://www.corrections.nebraska.gov/sites/default/files/files/41/2019-2023_strategic_plan_final.pdf

⁸⁸ The first two plans had the six year capital construction plan but plans after that focused only on projects that had received funding.

⁸⁹ The NSP core services project would have updated several core areas of NSP for a cost of \$15.2 million. This request was rescinded by NDCS during the 2019 legislative session.

TABLE 5

FUTURE CONSIDERATIONS	STATUS
Nebraska State Penitentiary (NSP): Construction of an 80-bed high security restrictive housing unit could replace the existing 36-bed Control Unit (opened in 1955).	No request yet.
Lincoln Correctional Center/Diagnostic and Evaluation Center (LCC/DEC): A program statement for two living units, each housing 192 maximum security inmates (384 design beds), has been completed. This project could address agency needs for high security housing, allow for the conversion of LCC to full medium custody and contribute to meeting agency capacity needs.	\$49 million for the project was funded by the Legislature in the 2019 legislative session.
Omaha Correctional Center (OCC): Future needs include expanding the family visiting area, medical services area, food service and programming space.	No request yet.
Work Ethic Camp (WEC): A program statement has been completed to address essential services such as intake/medical/recreation. Adding to the warehouse could provide adequate storage of supplies needed to operate the facility. Completion of these projects could allow for expanded bed space in the future.	No request yet.
Nebraska Correctional Center for Women (NCCW): Remodeling living units, expanding programming space and upgrading security may be needed.	No request yet.

In December 2018 the NDCS Strategic Plan Progress Report for Fiscal Year 2017-2018 was released.⁹⁰ It reiterates the five strategic goals that had been previously called “Leading Goals” and shares that each goal includes outcomes with multiple measures to ensure consistency and progress. There is more data regarding the goals in this report but there again was no information on the six year capital construction plan shared in the first strategic plan.

The OIG would recommend that the next strategic plan provide detailed information about each of the outcomes, strategies and measurements associated with the strategic goals to provide a more complete picture of what is taking place within NDCS. The OIG would also recommend that if goals are shared in the plan that details should be provided on how those goals are going to be achieved by NDCS.

⁹⁰ https://www.corrections.nebraska.gov/sites/default/files/files/270/2017-18_strategic_plan_progress_report.pdf

NDCS RESEARCH DIVISION

NDCS is not just correctional facilities. There are many other parts of NDCS that support their mission. The OIG is beginning to reach out to those other support areas to learn more about what they do to support NDCS. Earlier this year, the OIG communicated with the NDCS Research Director to learn more about the Research Division. Below is a description of their roles and responsibilities that was shared with the OIG by Dr. Abby Carbaugh.

Research Division Roles and Responsibilities: I also wanted to provide you with a short summary of the work that happens within the Research Division and the responsibilities of each of my teammates.

- 1. Research Director: The Research Director is responsible for the supervising all members of the Research Division and, when necessary, ensuring work is completed in their absence. The Research Director is also responsible for running high-level, complex analyses to ensure the Agency Director and his leadership team have the information available to them to aid in daily facility management and departmental strategic planning purposes; producing legislatively required statistical reports related to mandatory discharges and restrictive housing; and serving as a representative on a number of internal (e.g., Multidisciplinary Review Team, IT Governance Committee) and external (Seamless System of Services, CJIS Advisory Committee) workgroups. The Research Director also works in collaboration with external researchers interested in studying various aspects of NDCS to ensure their research questions and methodologies meet appropriate ethical standards, and to provide assistance in producing datasets and contextualization for the quantitative data provided.*
- 2. IT Business Systems Analyst: The IT Business Systems Analyst is primarily responsible for the development and maintenance of user requests for reports/iBots to be built in OBIEE, or for basic information requests. This person also is the point of contact for national reporting, such as ASCA's PBMS data (no longer active), BJS annual reports, Social Security Administration monthly reports, and other national data collection programs. The person in this role also monitors location history records for their accuracy, and performs other data auditing tasks, as needed.*
- 3. Data Auditor: The Data Auditor is charged with identifying discrepancies in data entry and generating reports to assist staff in cleaning up records with missing, illogical, or otherwise erroneous data. The person in this role also helps ensure information is easy to find by eliminating redundant or outdated reports and ensuring the dashboards are clear and concise. A secondary function of this position is to assist the IT Business Systems Analyst in responding to data requests and creating automated reports for end-users.*
- 4. Program Analyst: The Program Analyst works closely with the clinical and non-clinical program staff to monitor program data entry, as well as maintain OBIEE reports regarding waiting lists, enrollments, and completions. The person*

in this role is in charge of compiling the data for the Quarterly Programs Report and incorporating feedback from the Program Managers regarding any interpretations of trends or procedural changes that have occurred since the last report. As the need arises, this person assists in responding to one-off data requests, though, the primary job responsibilities revolve around program-related requests.

5. *Research Analyst: The Research Analyst works on projects that involve more in-depth analysis and reporting. Typically, the person in this role uses reports and tools outside of OBIEE (e.g., Access, Excel, Stata) to complete their analyses. Generally, the person in this role focuses on broad departmental topics, such as staffing issues (e.g., assaults on staff, vacancies and turnover rates), risk assessment (e.g., STRONG-R risk distributions, generating lists of people with reassessments coming due), and population trends. As the need arises, this person assists in responding to one-off data requests, though, the primary job responsibilities revolve around more in-depth analyses of issues related to strategic planning.*

6. *Ph.D.-level Intern: This position is currently vacant. When it is filled, the person in this role assists with higher-level causal data modeling, and developing the logical sequences for analyses for requests that are complex or involve data with subtle nuances that could be overlooked if not all factors are accounted for. In addition to some of the day-to-day tasks, the majority of this person's time is expected to be spent working on an in-depth research project of NDCS's population, programs, or services, that would meet his or her dissertation requirements. NDCS benefits by receiving a solid evaluation project, the student benefits by receiving access to data for their dissertation and agency staff who can provide clarifications and context for the data, and both parties benefit by building a relationship that can be leveraged for future research needs.*

The OIG appreciates the information provided by Dr. Carbaugh and looks forward to working with her team to gain a better understanding of NDCS issues.

CENTRAL OFFICE WORK ENVIRONMENT

During the past two years there have been a number of individuals who have left employment from the NDCS central office. The people in these positions vary from purchasing to human resources to budget to reentry and many more areas that are key in the success of NDCS. Some individuals have reached out to the OIG during their employment or after their employment and have expressed concerns about the work environment in central office. The OIG has also met with others who did not experience a difficult work environment or chose not to share their experiences.

There have been two primary concerns expressed to the OIG. First, that in many areas they are short-staffed. NDCS' responsibilities have expanded yet the number of employees providing support in those areas has not increased. To some, this impacted the ability to carry out their duties and responsibilities in a timely, efficient and productive manner. Second, multiple people expressed concerns about the environment in which they are employed, including a top-down management style where input is discouraged. They also have shared other concerns about the environment with the OIG.

There have been enough concerns expressed to the OIG over the past two years that it is recommended that the Governor or Director Frakes bring in an independent and external review team to review the employment conditions in the central office area. This review could determine whether the issues raised with the OIG actually exist and if so to what extent, and whether or not action can be taken to address those issues so that the work culture can improve. A review like this should be welcomed so that any concerns can be addressed in a positive manner and assist NDCS in moving forward.

DIVISION OF PAROLE SUPERVISION

In 2015, the Legislature passed Legislative Bill 598 to transfer the administration of the Division of Parole Supervision (Parole) from NDCS to the Board of Parole effective July 1, 2016. The transition to the Board of Parole was made on July 1, 2016.⁹¹ The Director of Parole Supervision is Julie Micek.

It has now been three years since Parole was placed under the Board of Parole. Many changes have taken place and the OIG visits with staff of Parole on a regular basis and also communicates with members of the Board of Parole when necessary. Parole has been extremely open and transparent with the OIG.

Each year, the OIG has asked Director Micek if she would be willing to prepare a document that discusses the activities of the Division of Parole Supervision during the past year, along with any successes, challenges, and plans for the future. Director Micek provided a report again this year.⁹² The report provides a quick overview of the activities of the Division. The Division's Annual Update 2019 will be published in the near future.

One of the activities of the Division this past year was presenting to the Council of State Governments about EBP (evidence-based practices) implementation. It shares their growth in the use of EBP starting from the Justice Reinvestment Initiative in 2014 and continuing to the present day. Their presentation provides information about their commitment to this process.⁹³

On December 31, 2018 the Division released their annual report on parole revocations.⁹⁴ The report is attached and provides information and data on parole revocations, including:

- 58% of all review of parole hearings were due to a law violation and the remaining 42% were prompted by technical violations;
- Narcotics possession or refusal to be tested is the most prevalent parole violation;
- 396 individuals had parole revocation hearings in FY 2018 and parole was revoked in 89.6% of those cases;
- Parole hearing counts and outcomes by date;
- Data on the number of violations per client before a parole hearing was held; and,
- Demographics on parole clients who have a review of their parole hearing.

The Division also provided a great deal of statistical information to the OIG as part of the response to the request for information. This information will be thoroughly reviewed and analyzed and will be part of a special report on parole that will come out by February 1, 2020.

Summary

As shared in the 2018 OIG Annual Report, the Division of Parole Supervision has taken significant steps in the past few years but many challenges remain as they attempt to move

⁹¹ The transition report can be found at http://nebraskalegislature.gov/FloorDocs/104/PDF/Agencies/Parole_Board/585_20160603-101354.pdf

⁹² Attachment Q: Report from Director Micek

⁹³ Attachment R: Division of Parole Supervision's PowerPoint presentation to CSG

⁹⁴ Attachment S: 2018 Annual Report on Parole Revocations

forward. In the past year, the OIG has not been contacted by either a Parole staff member or a parolee with any concerns regarding Parole and its practices. Last year, the OIG followed the case of a person who had been recently released on parole in order to learn more about the parole process. The OIG had met this individual during his lengthy stay in restrictive housing. He was paroled after being removed from restrictive housing and completing the Violence Reduction Program. The OIG maintained contact with the parolee, his family and the parole officer during his time on parole. He successfully completed parole in early 2019.

RECOMMENDATIONS

Throughout the report there were many observations made by the OIG that resulted in these specific recommendations.

The following are recommendations by the OIG:

- The OIG would strongly recommend that the Governor, the Legislature and NDCS work together and create a comprehensive task force that will conduct a strenuous in-depth examination of the staffing problems facing NDCS.
- The OIG would recommend that the Governor, the Legislature and the Judiciary work together and create a comprehensive task force that will address the correctional overcrowding issue by seeking and implementing solutions.
- NDCS should include information on the OCC Special Detail only filling a percentage of an entire position in their vacancy data.
- NDCS needs to review the issue of wage compression between salary and non-salary staff, as well as the salary structure of wardens and other administrative positions.
- NDCS should review the possibility of hiring individuals with criminal histories.
- NDCS should include facility staff at staff recruiting events.
- NDCS should bring in experienced and respected Sergeants, Lieutenants and Majors to assist with mentoring the current NSP staff. Consideration should be given to utilizing retired staff as mentors as well.
- Nebraska has a low overall incarceration rate but has the 10th highest racial disparity ranking when comparing incarceration rates of black and white individuals. Nebraska policy makers should more closely examine this issue in order to determine what can be done to focus on that disproportionate incarceration rate, and what are the consequences of having such a high disparity rate.
- NDCS should develop a long-term plan for addressing and financing their maintenance backlog and for the development of appropriate and needed core support services throughout the system.
- NDCS should track and report all inmate on inmate assaults.
- NDCS should expand the use of body cameras, especially at LCC.
- NDCS should task each facility with generating a report about institutional camera blind spots and determine how and when to address those areas.
- NDCS should consider publishing a report and sharing it that provides an update on the reaction and implementation of the Vera restrictive housing recommendations.
- NDCS should end the practice of double bunking in a restrictive housing setting in order to comply with ACA standards.
- NDCS leaders and Legislative leaders should make a joint visit to Colorado to learn more about their restrictive housing reforms.
- NDCS should collect data on contraband turned over to the Nebraska State Patrol that is not shared with NDCS or the OIG.
- NDCS should review data and timing of staff searches in order to determine whether changes can be made to make them more effective and less predictable as well as review the possibility of having dedicated search staff that examine everything brought into the facility via truck.

- NDCS should reinstate domestic violence programming.
- NDCS should review the effectiveness of the delivery of the substance abuse treatment programs and consider working jointly with community treatment providers to improve and enhance the program. The review should also examine any issues with attracting and retaining staff for the program.
- Nebraska should take steps to enact state policies that encourage the hiring of previously incarcerated individuals.
- NDCS' next strategic plan should provide detailed information about each of the outcomes, strategies and measurements associated with the strategic goals to provide a more complete picture of what is taking place within NDCS. If goals are shared in the plan then details should be provided on how those goals are going to be achieved by NDCS.
- The Governor or NDCS should bring in an independent and external review team to review the employment conditions in the central office area.
- Parole should continue to review the capabilities of expanding their role to provide re-entry services and community corrections opportunities.
- Parole should continue to work with the Office of Probation Administration to jointly use community resources, including the day reporting centers.

Status of Past NDCS Recommendations

During the past three years, the OIG has made numerous recommendations to NDCS. At the request of the OIG, NDCS recently provided the OIG with an update or feedback on those recommendations. The recommendations are attached to this report.⁹⁵

⁹⁵ Attachment T : NDCS Recommendations Spreadsheet, July 2019

OIG RESOURCES AND GOALS

As the OIG enters the fifth year of the existence of the Office, there are a number of goals and expectations for the work ahead. One of the challenges facing the OIG is the lack of additional staff to assist with the work. Over the past four years the demands on the OIG have significantly increased and the result is that the OIG has to prioritize issues and understand that there will be issues or parts of the correctional and parole systems that will not be able to be closely examined due to a lack of time or resources. There are significant issues that are not reviewed or investigated due to the lack of resources for the OIG. Should the Legislature decide to provide an additional staff member(s) to assist the OIG the investment will be well-spent.

The goals for year five of the OIG are similar to previous years although some of these have not been met in recent years:

- Attend an inmate council meeting at each facility;
- Continue to increase interaction with NDCS staff, including job shadowing;
- Provide detailed special reports or updates on specific issues;
- Conduct a more in-depth review of Parole and provide it to policy makers by the end of 2019;
- Conduct a survey of the employees of the Division of Parole Supervision;
- Continue to maintain contact with each program that receives funding from the Vocational and Life Skills Program;
- Conduct at least one survey of inmates at a facility;
- Continue to communicate with policy makers and be responsive to their requests for information; and
- Always be open to suggestions for improvements.

CONCLUSION

Completing an annual report is a quite an endeavor. It is an eye opening look at all of the activity that is taking place within and around our correctional and parole systems in Nebraska.

This report has been filled with information and data in an attempt to share as much with the reader as is possible so that they understand the activities of NDCS and Parole. It has been the hope of the OIG that these annual reports will not only provide such an understanding but can also be a resource for those interested in these areas. This fourth annual report does not go into as great of detail as the 2018 OIG Annual Report but between the two reports the reader has access to a great deal of information.

The OIG would again like to thank all of the individuals who have contributed to the contents of this report. Contributions have been made by countless individuals including NDCS staff and administrators, Board of Parole members, Division of Parole Services staff and administrators, community members, current and former incarcerated individuals, the Ombudsman's office, Nebraska Senators, legislative staff and many others.

A

2018 RETENTION PROJECT

Nebraska Department of Correctional Services (NDCS)

Published July 2019

Introduction

At the request of Director Scott R. Frakes, a project was undertaken to gain a comprehensive understanding of issues that contribute to teammate retention at NDCS, as well as factors that might serve to cause employees to leave their jobs. Comparisons were made across facilities and job types in response to particular questions related to future employment at NDCS, including factors that would prompt employees to stay or leave and changes that teammates felt essential in order to remain with the agency.

Methodology

The process consisted of questioning 469 teammates individually by a team of mid-level and frontline staff members. The interview process was largely informal, allowing respondents to provide a variety of responses to follow-up questions.

In-person, confidential interviews were conducted across all NDCS facilities with the exception of Central Office. Those facilities include the: Community Corrections Center-Lincoln (CCC-L), Community Corrections Center-Omaha (CCC-O), Diagnostic and Evaluation Center (DEC), Lincoln Correctional Center (LCC), Nebraska Correctional Center for Women (NCCW), Nebraska Correctional Youth Facility (NCYF), Nebraska State Penitentiary (NSP), Omaha Correctional Center (OCC), Tecumseh State Correctional Institution (TSCI) and Work Ethic Camp (WEC).

Subjects were interviewed one-on-one. Respondents represented a wide cross section of job classifications and shifts within those facilities. The objective was to have at least 30 percent of teammates from each facility complete the interviews. That was followed by qualitative analysis of the results and issuance of this report.

Analysis

Of the 469 teammates interviewed as part of this project, 57 percent (**Table 1**) indicated they would be working at NDCS in the next five years. Twenty-four percent said they did not feel they would still be with the agency and 19 percent said *maybe*.

Table 1 Do you see yourself working for NDCS in the next five years?

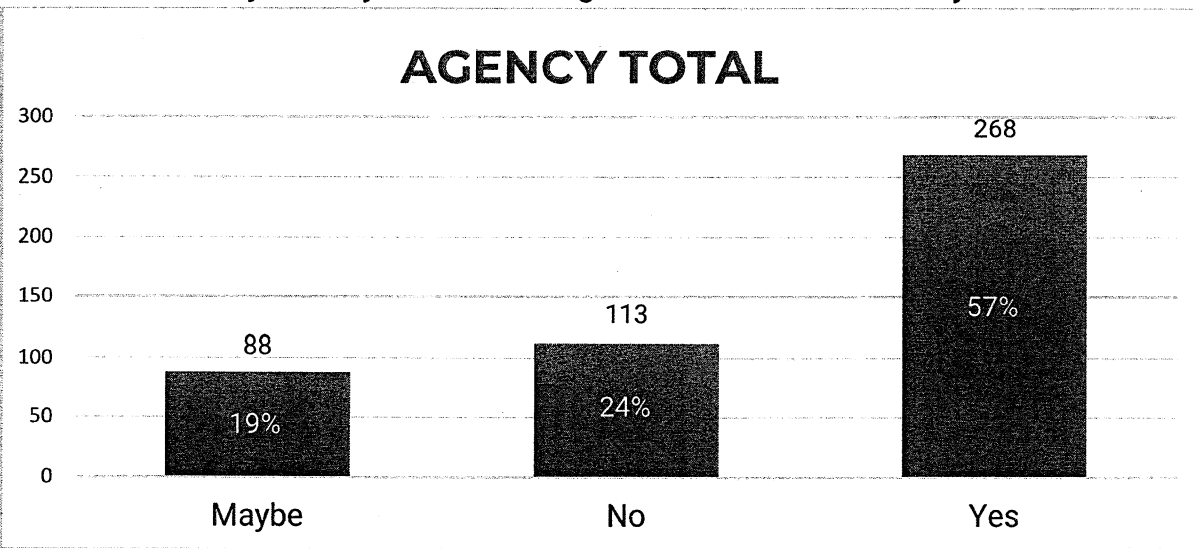

There were 469 responses to the question, “Do you see yourself working for NDCS in the next five years?” Responses were categorized as: yes, no and maybe. Anyone who responded with “I don’t know” was categorized as “maybe.”

In order to gain more context from the *yes*, *no* and *maybe* responses, each teammate was asked to provide further explanation related to their particular response. Answers varied widely, but several key themes were identified within each category (*yes*, *no* and *maybe*). In order to capture all of the responses provided by each teammate, every response was recorded and included in the total. For example, among teammates who indicated they would continue to be employed in five years, if they had multiple reasons for remaining on the job, each response was noted and included in the tally.

Overwhelmingly, people who said they would continue to be employed (**Table 2**), indicated that enjoyment of their job was a key reason. That response was followed by having good co-workers and pay.

Table 19

If you could change anything, what would it be?

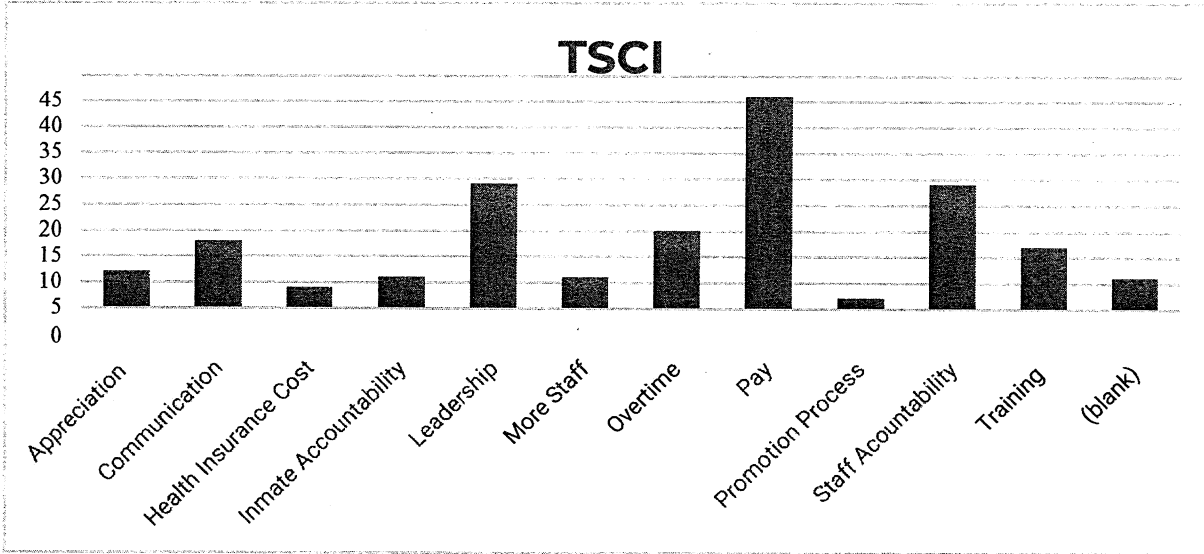

Examining the breakdown across job duties, again, a pay increase was the top recommendation to the question, “If you could change anything, what would it be?” That was true among custody staff, food service, maintenance, recreation specialists, and unit staff. The only group of teammates for which pay was not ranked highest was warehouse staff. Admittedly, that response group consisted of only four individuals. Two people advocated for leadership changes, one person indicated pay and the fourth person said inmate accountability would be a recommended change. The sample size may have been too small to clearly differentiate what would be the top priority. Across most jobs, staff accountability and leadership were top suggestions for change.

When asked specifically about recommended changes pertaining to leadership (Table 20), across all respondents, having a better immediate supervisor was the top selection. The other suggestions (improved communication, increased administrative presence, more appreciation and more support) all ranked about the same as a follow up choice.

Table 20

If you could change anything, what would it be?

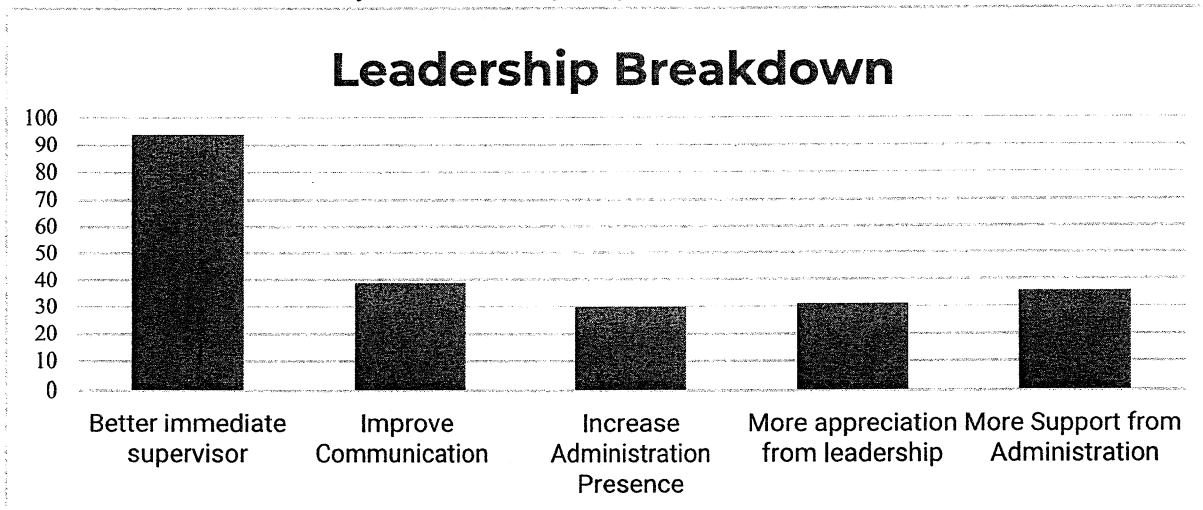

Conclusion

This survey was designed to identify factors that would influence the decision by teammates to remain employed at NDCS as well as solicit ideas for change. While a majority of people saw themselves working for NDCS in five years, among those who said *maybe* or *no*, they indicated that in order to remain, pay increases would be required.

Of those who said they would stay, the primary reason was enjoyment of the job. Pay was a lesser consideration (behind having good co-workers). Among the facilities included in the survey, only two had more *no* than *yes* responses as to whether they would continue to be employed in five years. Across job classifications, the majority of teammates indicated they would stay.

When asked to provide input on changes related to retention, many people indicated that an increase in pay was necessary, which correlates to the top reason people feel they will not remain with the agency or are contemplating leaving NDCS. With regard to that question, employees were able to provide multiple responses – and they also placed heavy significance on leadership, staff accountability and overtime.

As noted in this report, pay increases were not yet negotiated at the time teammates were questioned. Having those increases in place might have impacted responses related to pay. For instance, it may have resulted in a greater shift to leadership, accountability or other factors as suggestions for change.

Next Steps (by Director Frakes)

Improvements to compensation and leadership were the top areas of improvement identified by respondents. Despite significant progress in 2019, compensation remains a leading issue. Over 20 percent of the staff do not have a longevity component as part of their pay.

Wages for health care/behavioral health care staff are below market rates for several job classes. Wage compression between represented staff and supervisors was impacted by the recent contract agreement with the Fraternal Order of Police (FOP). The agency must continue to work on addressing compensation issues as part of its retention strategy.

NDCS announced a major staff initiative in 2019, focusing on staff engagement. Working in partnership with Gallup, the agency is focused on implementing tools and approaches for supervisors. While compensation is important for retention, money alone does not lead to employee engagement. Staff engagement is directly linked to the leaders for whom they work. The primary retention focus for the next 12 months will be increasing staff engagement using the Gallup Q12 process and the Clifton StrengthsFinder tools.

My thanks to the people who took part in designing and carrying out this project. The lessons learned about methodology and implementation were just as valuable as the information gathered by talking with staff.

2018 NSP Supplemental Report Recommendations	Status/Response July 2019	OIG Response (August 18, 2019)
Currently, staff at the Tecumseh State Correctional Institute have the opportunity to be paid more for merit and longevity reasons. This pay program should be provided to staff at NSP in an effort to reduce turnover and vacancies.	Addressed through contract negotiations and agency initiatives	This is an encouraging development. It is something that could have been done much earlier as the situation at NSP worsened but at least it is now being addressed.
NDCS should review options related to the conversion of the external housing units into programming space and construct new minimum housing units that are rehabilitative and more efficient.	While NSP does need more programming space, it is more cost effective to build new rather than remodel the existing space	At some point, the external housing units will see the end of their lifespan as residential housing units. This was shared in the report, as was the original belief by then NDCS Director Harold Clarke that they would not be able to function as living units for the entirety of their lifespan.
Review the need to construct a second indoor recreation area for the facility.	Too many competing construction needs with higher priorities	This is still a concern that needs to be addressed at some point.
Place cameras in identified "blind spots" in the Internal housing units and review security camera needs throughout the facility.	Review and upgrading of camera security systems is an on-going process	A recent assault in Housing Unit 4 demonstrated that the concern with "blind spots" still exists.
Review the use of the kitchen area in internal housing units and determine whether they can be used as a vending area or a recreation area.2	Use of the dining hall for pro-social activities is an option available to the facility, based on available staff supervision resources	The report meant the areas in each housing unit that were originally designed as a type of kitchen or food serving area. The OIG should have provided more details when presenting this recommendation. It is my understanding that there are discussions taking place on this issue at NSP.
Provide for access to a law library computer in Housing Units 2 and 3.	Current access is adequate	This is still a valid concern that could easily be addressed. Many times, inmates in those housing units have their movement restricted or access to the law library is restricted due to staffing issues. More law library computers are being added in Housing Unit 4 and they could be installed in these other units as well.
Develop a plan in the near future to address the nursing shortage. (Review past OIG recommendations if necessary.)	Efforts to recruit and retain nursing staff continue, including increased compensation and certification as correctional health care workers	Earlier this year, the skilled nursing facility was negatively impacted by the lack of nurses. NDCS took steps to address this and the skilled nursing facility was re-opened.
End double bunking in restrictive housing so that the ACA standards will be met.	ACA standards do not prohibit double bunking in restrictive housing	As laid out in the report, the ACA standard referred to by the OIG was the amount of space required by the ACA in ACA Standard 4-414 ("All cells/room in segregation provide a minimum of 80 square feet, of which 35 square feet is unencumbered space."). The OIG never stated in the report that there was an ACA standard on double bunking in restrictive housing.
Convene a short-term work group consisting of unit staff and inmates to discuss other options for creating day room space or out of cell opportunities within a living unit or connected to a living unit	The Inmate Council process provides the opportunity for conversations of this nature	Point well taken.
Establish a goal to "right-size" Housing Units 7 and 8 so that they can function in a safe and productive manner. If these facilities had 100 men in them instead of 200 men the environment would be much better for the staff and the inmates.	The 100 bed construction project at NSP was initiated consistent with (and prior to) this recommendation	It is the hope of the OIG that this goal is realized by NDCS.
NDCS and the OIG should work together to conduct similar assessments of other state correctional facilities.		The OIG still would like to extend this offer of cooperation.

Assessment of Nebraska State Penitentiary
Conduct between 30 January 2018 – 2 February 2018
At the request of Scott Frakes, NDCS Director
Assessment conduct by Jeff Wooten

Between 30 January 2018 and 2 February 2018, I was instructed to conduct an assessment of the Nebraska State Penitentiary (NSP) by Director Scott Frakes due to the overwhelming challenges regarding staff vacancies, inmate unruliness, low morale, and overall issues plagued at NSP.

Individuals questioned in the assessment were staff ranging in ages from 19-61 with time in service (TIS) with NDCS from 6 months to 28 years, and to a lesser degree, several inmates (approximately six) were questioned regarding their concerns and observations.

During the assessment there were many discussions from staff and inmates on how to improve conditions, morale, structure and environment; however, I concentrated on finding relevant common themes throughout the assessment. Four themes, or constants kept revealing themselves in conversation with staff and two themes with conversations with inmates.

Themes found within staff:

1. Training
2. Team consistency
3. Treatment of inmates
4. Leadership

Themes found within inmates:

1. Consistency between shifts
2. Treatment of inmates

Findings and Recommendations made to Director Frakes and Diane Sabatka-Rine:

1. Training – Staff relayed that training conducted at the Staff Training Academy is not relevant to what is endured once s/he has graduated and assigned a facility. The Field Training Officer (FTO) program is inadequate and cannot keep up with the demands of new hires. More than often, a new hire is placed in the control center or “bubble” without any training and remains there for one to two weeks. According to staff at NSP, the control center is the hub or nucleus that keeps the housing unit running smoothly and having an inexperienced officer only complicates the daily process and frustrates the inmates.

Senior officers, Sergeants and Lieutenants also do not feel that it is their responsibility to teach, coach, and mentor new hires, so new hires feel as if they are secluded from the team. This is a never-ending cycle since the FTOs do not have adequate time to train new hires and senior officers do not feel it is their responsibility, new hires get frustrated, apprehensive and leave to find work elsewhere.

Recommendation to Director Frakes and Diane Sabatka Rine: I recommended to Director Frakes and Diane Sabatka-Rine that NDCS find the best Sergeant and Lieutenants across the agency, bring them to NDCS (compensated), as a mentorship program to teach, coach and train supervisors.

2. Team Consistency – Every staff member I spoke to relayed that going to a team concept would alleviate a large portion of issues and challenges. Rather than having many utility posts, where an officer works in different housing units daily, maintain a team concept, where all three shifts

are the same individuals. This creates trust amongst the officers, consistency within the team, and will assist with maintaining order and discipline among the inmates, which was also a complaint from the inmate population.

Recommendation to Director Frakes and Diane-Sabatka-Rine: I recommended that NDCS try a pilot program of the team concept. It had been done in the past and according to senior staff, it worked categorically well.

3. Treatment of inmates – This finding was found between staff and inmates. Although I did not find any incident reviews (staff did say they did write it up), there are senior staff who purposely treat inmates poorly and provoke inmates to conduct bad behavior. Once incident reported to me, and discussed with Frakes and Sabatka-Rine, as an example, was when a senior Sergeant who knowingly knew that an inmate did not speak English, repeatedly gave orders for him to get on the ground and 'cuff up'. When the inmate refused because he did not understand the directives, the Sergeant proceeded to aggressively slam the inmate to the ground.

Although this is just one example, several staff and inmates relayed that this the norm throughout NSP.

Recommendation to Director Frakes and Diane-Sabatka-Rine: Again, recommended a mentor program to alleviate this happening in the future. I also recommended to Christine Carter (head of NDCS Leadership Academy) several months earlier, that NDCS initiate a mentor program based off the military program of assigning a 'sponsor' that would meet with new hires going through the academy at week two. This sponsor would be the primary point of contact for the new hire in the facility they would be assigned to and stay with them during the entire training or probation period.

4. Leadership – This was the main theme throughout every discussion with staff that if remedied, would alleviate most, if not all the challenges NSP and NDCS face. Supervisors do not take the time to teach, coach, or train new hires, or sustain the training of senior staff. It is their opinion (field staff) that there is no leadership, only supervisors and managers.

This permeates the facility to take on the role of coming to work, doing the minimal amount required and then go home.

Recommendation to Director Frakes and Diane-Sabatka Rine: Revise curriculum of the Leadership academy to concentrate on senior leaders. Focus on taking care of staff, showing concern for their well-being, promote professional development, along with focusing on internal development to make the individual a better leader. Also, recommended a mentorship program where NDCS brings the best leaders across the agency into NSP.

*I ended my conversations with Director Frakes and Diane Sabatka-Rine on a personal leadership observation: NSP had a Deputy Warden (Hurt) acting as a Unit Administrator in 2A. I relayed that the optics of this move does not promote effective leadership and removes any previous authority the Deputy Warden previously had. Both Director Frakes and Diane Sabatka-Rine agreed with this assessment.

News Release

C

FOR IMMEDIATE RELEASE (19-51)

CONTACT Laura Strimple, Chief of Staff
OFFICE 402-479-5713 | laura.strimple@nebraska.gov

Correctional facility on lockdown as intensive searches get underway

September 4, 2019 (Lincoln, Neb.) – Director Scott R. Frakes says he is taking a no-holds-barred approach to stemming a recent uptick in assaults, drug exposures and contraband at the Nebraska State Penitentiary. The entire facility has been placed on lockdown* since this morning.

“That will continue to be the case until further notice,” noted Director Frakes. “During this time we will have staff members doing organized and intensive searches of housing units, looking specifically for alcohol, drugs, weapons and cell phones.”

All visitation hours with inmates through Friday are canceled. During the Labor Day holiday, visitation was canceled due to reduced staffing. Director Frakes said the decision to go into lockdown was not the result of staffing challenges, but a decision to undertake actions necessary to address safety. “We’ve been doing concentrated, surprise searches for a number of years, including at the penitentiary. This is not new, but it is certainly on a larger scale.”

“Over the past month or so there has been an increase in assaults, not only on staff members, but also among inmates,” added Michele Wilhelm, warden at the penitentiary. “One assault resulted in a staff member receiving treatment at the hospital. Additionally, a few inmates have received outside treatment for injuries.”

Director Frakes said that introduction of K2 (commonly referred to as synthetic marijuana) into the penitentiary has also been on the rise. Several vials of the substance were confiscated in the past month, but individuals continue to be intoxicated.

“No matter if it’s K2, alcohol or other substances, staff members are dealing with inmates who are intoxicated and are often confrontational when they are in that state,” said Director Frakes. “That, in addition to the homemade weapons that have been

D

FOR IMMEDIATE RELEASE (19-52)

CONTACT Laura Strimple, Chief of Staff
OFFICE 402-479-5713 | laura.strimple@nebraska.gov

Lockdown ends as penitentiary moves to modified operations

September 6, 2019 (Lincoln, Neb.) – The Nebraska State Penitentiary is moving off lockdown* status, but will remain on modified operations* at least through the weekend. Scott R. Frakes, director of the Nebraska Department of Correctional Services (NDCS), says outside visits to the facility will continue to be canceled during that time, but the step down to modified operations will allow inmates to have some controlled movement outside of their cells.

“For instance, they will start to have access to the showers and their dayrooms, but there will not be any unescorted movement off of the units,” explained Director Frakes.

Inmates started receiving notice of the planned changes on Thursday night. “They will continue to be notified throughout the process,” said Director Frakes. “We want the communication to be as clear as possible to the inmate population as well as staff members.”

The penitentiary went into lockdown on Wednesday morning so that organized and intensive searches could be conducted of cells, restrooms, dayrooms and other spaces. “The decision to shut down activity across the facility was not spurred by any single incident,” said Director Frakes. “But, there was no doubt that strong and direct action needed to be taken based on the number of recent assaults and discovery of contraband.”

Director Frakes said he is not ready to discuss what may have been uncovered in this recent sweep. “Suffice to say, we are now focused on moving operations back to normal, but in a precise and controlled way.”

Michele Wilhelm, warden of the penitentiary, said inmates have been cooperative during the lockdown. “It is stressful anytime there is a break in routine and I can appreciate

Neb. Rev. Stat. § 83-907 Report: Implementing the § 83-962 Parole Review Process

December 1, 2018

Submitted by:

Roslyn Cotton, Chair, Nebraska Board of Parole

Scott R. Frakes, Director, Nebraska Department of Correctional Services

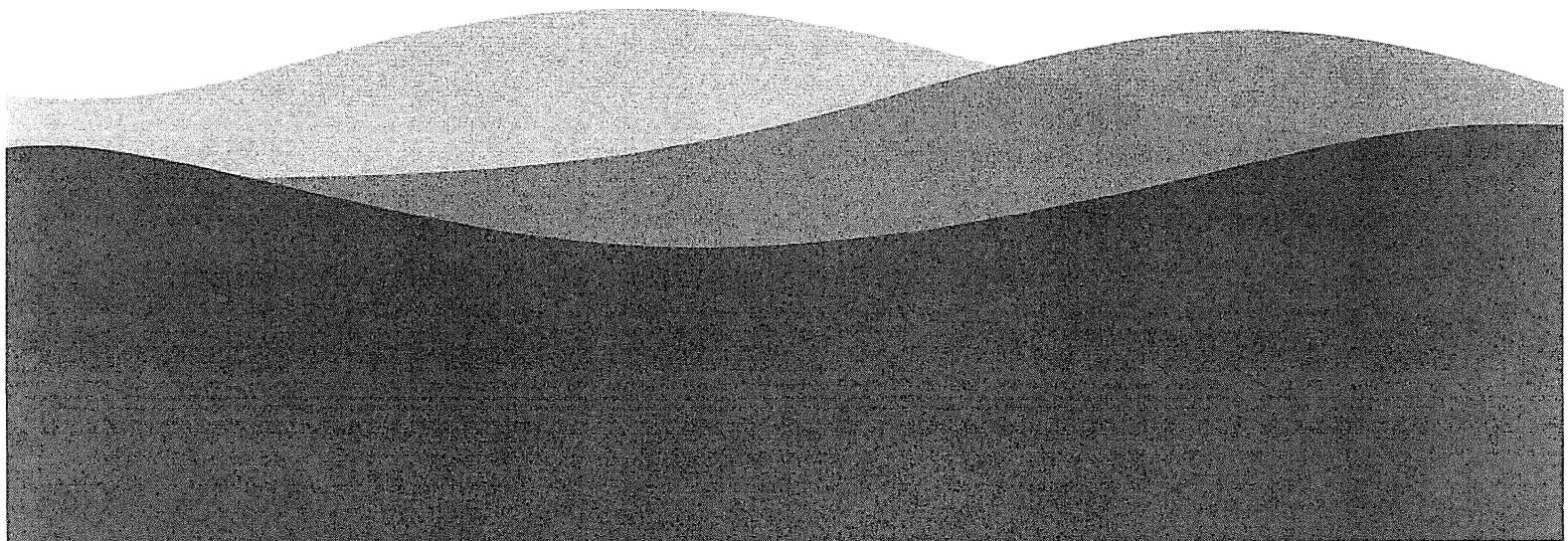

Introduction

The Nebraska Department of Correctional Services (NDCS) and the Parole Board drafted this report to comply with Neb. Rev. Stat. §83-907. That section requires NDCS and the Parole Board to submit to the Legislature a proposed plan which describes the process of implementing the accelerated parole review process required by Neb. Rev. Stat. §83-962 if a correctional system overcrowding emergency is ever declared or determined to exist.

This report addresses the following issues, as required by §83-907:

1. The process by which the NDCS director shall certify that an overcrowding emergency exists
2. The process by which the department shall prepare and submit to the board a listing of parole-eligible inmates to be considered or reconsidered accelerated for parole
3. Any statutory changes required or funding necessary to accommodate such process
4. The process by which the board shall examine inmates during the accelerated parole review
5. A review of the analysis for granting parole pursuant to section §83-1,114 and whether this process and the factors set out in such section are sufficient or adequate for the accelerated parole review process required by section §83-962
6. A review of the process of supervising parolees released pursuant to the accelerated review process and the necessary means to ensure public safety
7. Any statutory changes required or resources necessary to accommodate the existence of an overcrowding emergency status and to facilitate the potential requisite gubernatorial declaration of such emergency

Recent Efforts

Over the past three years, NDCS and the Parole Board have worked individually and collaboratively to increase the number of inmates prepared for parole, paroled and successful under supervision.

Parole Board has:

- Improved the parole guidelines by implementing a risk assessment tool that generates a concrete risk rating
- Set inmates for parole hearings up to two years from parole eligibility
 - Initiating the parole process earlier provides inmates with the incentive to take advantage of programming and the time to complete it before parole eligibility
- Began providing certificates to inmates who complete programs in an effort to motivate them to continue working on their rehabilitation in preparation for parole
- Reviewed inmates with hearings set in the future to determine if they can be set for an earlier date
- Reviewed inmates who are set for reviews and setting them earlier when possible
- Brought in national experts to train and guide Board members in best practices to assist with motivational interviewing techniques and use of risk assessments

Parole Board, through its Division of Parole Supervision (DPS), has also:

- Established Resource Centers in Lincoln and Omaha Regional Offices
- Implemented a new tool to assess parolees, prior to their release on parole, to identify what level of supervision (high, medium, or low) is required for each parolee
- Implemented an incentives and sanctions matrix, which has helped the Parole Board identify sanctions for parole violations that do not include sending the parolee back to prison

NDCS has:

- Implemented a new risk assessment tool that assesses an inmate's risk to reoffend and any factors or needs that may mitigate that risk
- Increased cognitive behavioral programming resources to more effectively rehabilitate inmates with a history of criminal thinking patterns
 - This effort will also help increase the number of inmates ready for parole

- Implemented process improvements that have allowed NDCS to reduce the time between when an inmate arrives at intake and when he or she has been assessed for rehabilitation and programming needs
 - Knowing programming requirements earlier in the sentence allows for goal setting, leads to greater engagement, and helps prepare the inmate for parole
- Implemented programming enhancements; increasing the intensity of certain programs and making them accessible to more inmates
- Continued efforts to ensure the agency is always using the “right inmate, right bed, right time” approach
- Expanded mission-specific housing to more effectively address needs of special populations
- Increased community beds to support transitions to parole

Implementing the § 83-962 Parole Review Process

(1) The process by which the Director of Correctional Services shall certify that an overcrowding emergency exists

The Director is required to certify that the prison population is above 140 percent capacity or that it has reached 125 percent of design capacity within 30 days of such occurrence. The Act does not require any specific process by which the NDCS Director is to certify design capacity. To comply with this requirement, the Director or NDCS would provide notice of design capacity.

(2) The process by which the department shall prepare and submit to the board a listing of parole-eligible committed offenders to be considered or reconsidered accelerated for parole

The current process for providing the Board a listing of parole-eligible committed offenders is sufficient to address an accelerated parole process. The Board has immediate access to NDCS' electronic data system, Nebraska Inmate Case Management System (NICaMS), which provides real time data regarding parole eligibility for all inmates in NDCS custody. The Board currently uses NICaMS to identify inmates who are eligible for parole reviews and hearings.

(3) Any statutory changes required or funding necessary to accommodate such process

The occurrence of an overcrowding emergency under the Overcrowding Emergency Act may, but is not certain to, occur at some future date. NDCS and the Parole Board would address any need for legislative changes, additional funding, or other resources, due to the occurrence of an overcrowding emergency or not, at that time.

At this particular time, there are no statutory requirements or funding necessary to accommodate section §83-907(1) or (2). Should the need arise, requests will be submitted to the legislature for prompt consideration.

(4) The process by which the board shall examine committed offenders during the accelerated parole review

The current process for reviewing parole-eligible inmates is to conduct a file or in-person review and, when appropriate, set inmates for public hearing. Notice of the hearing is published in advance.

Neb. Rev. Stat. §83-962 (2) states that during a correctional system-overcrowding emergency, the Board shall immediately consider or reconsider committed offenders eligible for parole who have not been released on parole.

The Board has already taken steps to reconsider parole for inmates who are past their parole eligibility date and is currently reconsidering inmates eligible for parole who have not had the opportunity to parole.

If necessary, the Board will conduct an increased number of reviews and hearings based upon the accelerated parole process. Board hearings may consist of three board members while board reviews may consist of two board members. The Board and NDCS will coordinate dates to schedule additional board reviews and board hearings.

(5) A review of the analysis for granting parole pursuant to section §83-1,114 and whether this process and the factors set out in such section are sufficient or adequate for the accelerated parole review process required by section §83-962

Currently, section §83-1,114(1) provides that the Board consider eligible inmates for release and order such release unless it is of the opinion that his or her release should be deferred because: (a) there is a substantial risk that he or she will not conform to the conditions of parole; (b) his or her release would depreciate the seriousness of his or her crime or promote disrespect of the law; (c) his or her release would have a substantially adverse effect on institutional discipline; or (d) his or her continued correctional treatment, medical care, or vocational or other training in the facility will substantially enhance his or her capacity to lead a law-abiding life when released at a later date.

The primary goal for the Board is public safety and a consideration of the factors listed above is consistent with this goal. The factors set forth in §83-1,114 are sufficient and adequate for the accelerated parole review process required by section §83-962.

(6) A review of the process of supervising parolees released pursuant to the accelerated review process and the necessary means to ensure public safety

The Board currently paroles all eligible inmates deemed appropriate. The accelerated parole review process and reconsideration of all parole eligible inmates may increase the number of parolees and, in particular, those with a higher risk to reoffend.

Under current standards and practices, the Division of Parole Supervision (DPS) supervises approximately 1,300 individuals. The current total caseload is composed of roughly one-third high risk and needs, one-third medium risk and needs, and one-third low-risk and needs. Over the course of the next two years, it is anticipated that in addition to an overall increase in total caseload, the caseload composition will lean more toward high-risk and high-needs individuals. If this scenario comes to fruition, it may require the addition of specialized officers and the provision of additional services and transitional housing.

Under current evidence-based practices, high risk and needs parole clients meet with their parole officer two times per month and, on average, participate in multiple programs (substance abuse treatment, life skills classes and cognitive restructuring). High risk and needs parole clients are supervised by specialized parole officers who carry a caseload of 30 at a given time.

In addition to increasing the number of officers, it will be necessary to adequately provision the need for services and transitional housing. Even with appropriate supervision level, treatment offerings, and housing options available, there are and will be those individuals who are unable to maintain their parole status for a host of reasons. These individuals will need to serve periods of custodial sanctions and/or may have their parole status revoked.

(7) Any statutory changes required or resources necessary to accommodate the existence of an overcrowding emergency status and to facilitate the potential requisite gubernatorial declaration of such emergency

At this time, no statutory changes are required to accommodate a possible overcrowding emergency status or gubernatorial declaration of such emergency that may or may not occur in the future. Any additional resources necessary to accommodate such status or declaration will be submitted to the Legislature for prompt consideration.

Inmate-on-Staff Assaults, July 1, 2016 - May 31, 2019
 Printed: July 24, 2019

Inmate-on-Staff Assaults

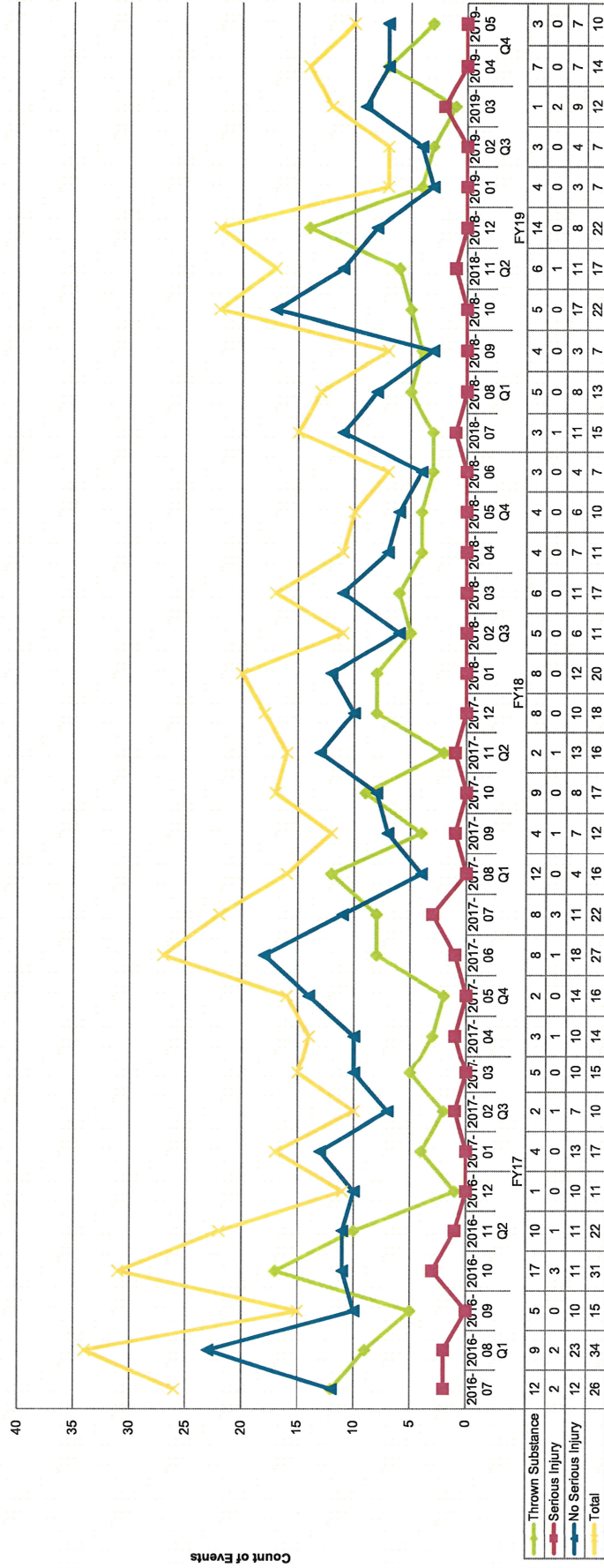

From the Literature . . .

by James E. Robertson*

Administrative Segregation: Making Periodic Reviews Meaningful

Featured

Perception Profiling and Prolonged Solitary Confinement Viewed Through the Lens of the Angola 3 Case: When Prison Officials Become Judges, Judges Become Visually Challenged, and Justice Becomes Legally Blind

Angela A. Allen-Bell
39 Hastings Const. L.Q. 763 (2012)

Administrative Segregation, Degrees of Isolation, and Incarceration: A National Overview of State and Federal Correctional Policies ("Time-in-Cell Report")

Hope Metcalf et al.
Liman Public Interest Program at Yale Law School (June 2013).
https://law.yale.edu/system/files/areal_center/liman/document/Liman_overview_segregation_June_25_2013_TO_POST_FINAL%281%29.pdf

Referenced

Thirteen Years in Ad Seg and Dubious Administrative Reviews

Fred Cohen
26 Correctional L. Rpt. 69 (2015)

Toward a Standard of Meaningful Review: Examining the Actual Protections Afforded to Prisoners in Long-Term Solitary Confinement

Elli Marcus
163 U. Pa. L. Rev. 1159 (2015)

The Constitution in Protective Custody: An Analysis of the Rights of Protective Custody Inmates

James E. Robertson
56 U. Cin. L. Rev. 91 (1987)

*James E. Robertson is Distinguished Faculty Scholar and Professor Emeritus of Corrections at Minnesota State University. He is a graduate of the law schools of Washington University and Oxford University. From 2002-2015 he was editor-in-chief of the *Criminal Law Bulletin*.

Time-In-Cell: A Practitioner's Perspective

A. T. Wall
125 Yale L.J.F. (2016)
<http://www.yalelawjournal.org/forum/time-in-cell-a-practitioners-perspective>

Introduction

Much has been made (and rightly so) of the damaging consequences of long-term solitary confinement. Moreover, as a commentator observed in 2012, "There is no shortage of information establishing the adverse medical effects of prolonged solitary confinement." Allen-Bell, 2012, p. 765. That body of information has since grown.

Far less has been written about the efficacy of the procedural safeguards that can arise when segregating an inmate for administrative rather than disciplinary purposes. This has been especially true of the periodic reviews that occur after an initial evidentiary review confirms an inmate's placement in solitary confinement for an indefinite period. However, the recent legal literature on the subject of periodic reviews has made up some of that lost ground. This column addresses two important additions to this literature through the prism of two U.S. Supreme Court decisions and one recent U.S. court of appeals decision on point.

Hewitt and Wilkinson

Assuming the presence of the requisite liberty interest, what process "comes due" to an inmate subject to administrative segregation, including the continuation of this form of prison housing? Two decisions by the U.S. Supreme Court about administrative segregation—*Hewitt v. Helms*, 459 U.S. 460 (1963), and *Wilkinson v. Austin*, 545 U.S. 209 (2005)—largely answer this question.

Before the *Hewitt* case reached the Supreme Court, some lower federal courts had held that long-term segregation for administrative reasons worked as many hardships as that of long-term segregation as a disciplinary punishment and thus required the same trial-like pro-

cedures prescribed by the Supreme Court in *Wolff v. McDonnell*, 418 U.S. 539 (1974), for inmates charged with serious disciplinary offenses. Robertson, 1987, p. 116 n.141 (citing cases). Indeed, such reasoning propelled the Third Circuit in *Helms v. Hewitt*, 655 F.2d 487, 500 (3d Cir. 1981), *rev'd*, 459 U.S. 460 (1983), to find that nothing less than the *Wolff* procedures had been due inmate Helms when he contested his transfer to administrative segregation. One court, *Calloway v. Fauver*, 544 F. Supp. 584 (D.N.J. 1982), went so far as to extend the *Wolff* procedures to periodic reviews of an inmate's administrative segregation status, but there was no consensus to that effect. Robertson, 1987, p. 116.

For determining the "process due" inmates possessing a liberty interest not to be housed in administrative segregation, the *Hewitt* and *Wilkinson* Courts used the generic formula set forth in *Mathews v. Eldridge*, 424 U.S. 319 (1976). The *Mathews* Court held that the following factors should be balanced:

- "First, the private interest that will be affected by the official action;
- "[S]econd, the risk of an erroneous deprivation of such interest through the procedures used, and the probable value, if any, of additional or substitute procedural safeguards;
- "[A]nd finally, the Government's interest, including the function involved and the fiscal and administrative burdens that the additional or substitute procedural requirement would entail."

Id. at 335.

For the *Hewitt* Court, balancing the above factors required procedural safeguards that fall far short of *Wolff*'s trial-like procedures.¹ Instead, the *Hewitt* Court prescribed an "informal non-adversary evidentiary review," to be followed by "some sort" of periodic review should the initial hearing support segregation. *Hewitt*, 459 U.S. at 477 and n.9.

Regarding the initial review, the *Hewitt* Court mandated the following procedures:

See FROM THE LITERATURE, next page

FROM THE LITERATURE, from page 25

- “[S]ome notice of the charges against him notice of the allegations;
- “[A]n opportunity [‘ordinarily a written statement’] to present his views to the prison official charged with deciding whether to transfer him to administrative segregation;
- “[A]nd the decisionmaker reviews the charges and then available evidence against the prisoner.”

Id. at 476-77.

As to the content of “some sort” of periodic post-segregation reviews, the **Hewitt** Court was silent but for a footnote. That footnote stated the following:

- “[A]dministrative segregation may not be used as a pretext for indefinite confinement of an inmate.
- “The decision whether a prisoner remains a security risk will be based on facts relating to a particular prisoner.
- “[A] wide range of administrative considerations are permitted, including officials’ general knowledge of prison conditions and tensions.”

Id. at 477, n.9.

In **Wilkinson v. Austin**, 545 U.S. 209 (2005), the Court again embraced “informal, non-adversary procedures” as the process due inmates exercising their liberty interest to avoid confinement in supermax prisons—where long-term administrative segregation under “highly restrictive conditions” is the norm. **Id.** at 209, 229. The **Wilkinson** Court presented the following rationale for adopting what it called the “**Hewitt** model” of due process:

[The defendant state officials are] not, for example, attempting . . . to revoke good-time credits for specific, serious misbehavior; see, e.g., **Wolff**, 418 U.S. at 539, where more formal, adversary-type procedures might be useful. Where the inquiry draws more on the experience of prison administrators, and where the State’s interest implicates the safety of other inmates and prison personnel, the informal, non-adversary procedures set forth in **Hewitt v. Helms** provide the appropriate model.”

Id. at 228-29.

Unlike **Hewitt**, however, the **Wilkinson** Court said nothing about periodic reviews. And the Court has remained silent but for its embrace of the **Hewitt** model,

which broadly dictates “some sort” of periodic review to ensure a continuing need for this variant of solitary confinement.

Justice Stevens’s Critique

Justice Stevens’s dissent in **Hewitt** also addressed periodic reviews, but he did so in the text of his opinion. He summarized the majority’s stance on periodic reviews as follows: “[T]he Court requires only minimal review procedures; prison officials need not permit the submission of any additional evidence or statements and need not give the inmate a chance to present his position.” **Hewitt**, 459 U.S. at 490 (Stevens, J., dissenting).

Moreover, Justice Stevens doubted that these procedures would prevent prison staff from continuing the segregation of an inmate “simply because prison officials believe that he should be punished” through a non-disciplinary avenue. **Id.** at 493. Furthermore, Justice Stevens suggested that the Court’s procedures would permit “mere paper-shuffling” to pass muster. **Id.** at 493.

“In my view,” wrote Justice Stevens, “the Due Process Clause requires a more searching review of the justifiability of continued confinement.” **Id.** at 491. He advocated supplementing the Court’s prescribed procedures with two additional safeguards:

- “[T]he prisoner should have the right to be present to explain his current attitude toward his past activities and his present.
- “[T]he decisionmaker . . . should be required to explain his reasons in a brief written statement which is retained in the file and given to the prisoner.”

Id. at 491.

In the two years immediately following **Hewitt**, two U.S. district courts signaled their affinity for Justice Stevens’s critique of **Hewitt**. Both courts held that segregation periods exceeding that of inmate **Hewitt**’s two years require heightened procedural safeguards, including objective evaluations by the decision-maker. See **Burton v. Shapp**, 574 F. Supp. 637 (W.D. Pa. 1983), *rev’d sub. nom.* **Mims v. Shapp**, 744 F.2d 946 (3d Cir. 1984); **Clark v. Brewer**, 578 F. Supp. 1501 (S.D. Iowa 1983), *modified*, **Clark v. Nix**, 578 F. Supp. 1515 (S.D. Iowa 1984), *aff’d as modified*, 776 F.2d 226 (8th Cir. 1985).

However, the U.S. Courts of Appeals held the line, rejecting any expansion of procedural due process. For example, in the aforementioned **Burton v. Shapp**, 574 F. Supp. 637, the U.S. District Court

for the Western District of Pennsylvania ruled that the plaintiff’s five-year segregation for non-disciplinary reasons necessitated objective criteria. On appeal to the Third Circuit, the three-judge panel reversed, explaining that “**Hewitt** validated the use of subjective evaluations by prison authorities.” **Mims**, *supra*, 744 F.2d at 953.

The Time-in-Cell Report

The Time-in-Cell Report advertises itself as “an overview of state and federal policies related to long-term isolation of inmates . . .” Metcalf et al., 2013, p. 1. A.T. Wall, the director of the Rhode Island Department of Corrections, goes one step further in praising it for “offer[ing] an unprecedented opportunity for those of us who supervise the operation of correctional facilities to see how this practice has been implemented across the country.” Wall, 2016, p. 246. Let’s be clear: By “implementation” he means the procedural mechanics of solitary confinement as they appear in writing—as distinct from their actual day-to-day implementation. The Time-in-Cell Report acknowledges this: “What cannot be known from this review is whether the policies are implemented as written, achieve the goals for which they are crafted, and at what costs.” Metcalf et al., 2013, p. 4.

Below are the principle findings of the Time-in-Cell Report with regard to periodic review procedures:

- “Every jurisdiction provides periodic review.” The interval between placement in segregation and the initial periodic review varies greatly across the spectrum of correctional agencies. In twenty-seven jurisdictions the first review occurs in 28 days or less, in the remaining jurisdictions anywhere from 30 days to one year will pass before the first review occurs. The time lapse between subsequent reviews is as follows: 28 days or less in 4 jurisdictions, 30 to 90 days in thirty-seven jurisdictions, and 6 to 12 months in the remaining six jurisdictions.
- “All but two jurisdictions that have periodic review specify the officials responsible for the review. Those officials fall into four groups: (1) staff at a facility . . . ; (2) warden/superintendent; (3) classification team/committee . . . ; (4) high-level administrators, e.g., the commissioner.
- “Twenty-nine jurisdictions authorize some type of hearing, with varying lev-

See FROM THE LITERATURE, next page

FROM THE LITERATURE, from page 26

els of formality

- “Most states do not specify that the inmate is to be notified in advance of the hearing; fourteen states require some kind of notice—ranging from 24 hours to 72 hours.
- “A few states specifically permit an inmate to be present at a hearing—with the caveat that exclusion is permissible if an inmate is seen to pose a threat to safety and security.
- “Many policies do not detail the sources of information used, the inmate’s opportunities to submit information, whether reasons are provided, or how subsequent decision-makers evaluate the decisions made.
- “Variation exists as to whether and how periodic review decisions are themselves either reviewed or appealed. Twenty-four states provide specific methods for review or appeals of decisions about continued placement, while other states permit appeals through regular grievance processes.
- “In several states, an inmate’s appeal goes to the warden, and those policies do not specify if any centralized authority reviews the decision.”

Metcalf et al., 2013, at 16-18.

The Time-in-Cell Report’s critique of these procedures largely mirrors Justice Stevens’s concerns. According to the study, not only do most departmental regulations fail to specify whether notice of a periodic review is to be provided, but they also lack guidance as to “the sources of information used; the inmate’s opportunities to submit information; whether reasons are provided, or how subsequent decision-makers evaluate the decisions made.” Metcalf et al., 2013, p. 6. In sum, these procedures leave ample room for the arbitrary continuation of solitary confinement.

What then are the key points in the Time-in-Cell Report? Its authors answer as follows:

Reading the many policies makes plain the degree of discretion accorded to correctional officials. At the formal policy level, most permit placement in segregation based on a wide range of rationales. The elasticity suggests that administrative segregation may be used for goals other than incapacitation. In exchanges about our inquiry into administrative segregation, several

commentators referred to the potential for its overuse based on what is colloquially known as being “mad” at a prisoner, as contrasted with being “scared” of that individual.

Metcalf et al., 2013, p. 4.

What Is a “Meaningful” Periodic Review? A Case Study

If we are faithful to the Framers’ concept of procedural justice, periodic reviews must be “meaningful.” Fred Cohen has concisely described the characteristics of a meaningful periodic review: “Meaningful review means an impartial review of the relevant facts, opportunity for input by the affected inmate, specification of the reason(s) for the confinement, and a fair opportunity to achieve the desired result.” Cohen, 2015, p. 74.

As illustrated by *Proctor v. LeClaire*, 846 F.3d 597 (2d Cir. 2017), regulations that in print appear meaningful may in practice fail to make the grade. The *Proctor* plaintiff, confined in a New York state prison, had spent 22 years in solitary confinement—“with no release date in sight.” *Id.* at 610. Periodic reviews of his segregation status always concluded that he represented a continuing threat to other inmates and staff, necessitating his continued isolation.

The plaintiff did have a considerable history of misconduct, including attempted escape for which he spent nine years in disciplinary segregation, after which he went directly into administrative segregation. Since his removal to administrative segregation, according to the *Proctor* Court, his disciplinary record was “in the main, . . . positive . . . with long stretches—including one period of almost four years—without any disciplinary reports.” *Id.* at 601. Consequently, the Second Circuit panel questioned whether the decision to place the plaintiff in administrative segregation immediately following completion of his ten-year sentence in disciplinary segregation had an unstated intent—“to punish the inmate doubly for the same infraction.” *Id.* at 601.

On its face, the regulatory code governing the *Proctor* plaintiff’s continuing segregation provided ample safeguards,² which led the U.S. District Court for the Northern District of New York to find for the defendants. In reversing and remanding, the Second Circuit concluded that this detailed regulatory code amounted to no more than “hollow formalities,” masking perfunctory, sham reviews that invariably concluded that the plaintiff was

preordained to disrupt institutional order. *Id.* at 612.

In *Proctor* the Second Circuit held that “it is well established that whenever process is constitutionally due, no matter the context, [i]t . . . must be granted at a meaningful time and in a meaningful manner.” *Id.* at 609. It proceeded to operationalize the concept of a constitutionally meaningful periodic review as follows:

- “First, the reviewing prison officials must evaluate whether the inmate’s continued Ad Seg [*i.e.*, administrative segregation] confinement is justified. It is not sufficient for officials to go through the motions of nominally conducting a review meeting when they have developed a pre-review conclusion that the inmate will be confined in Ad Seg no matter what the evidence shows.
- “Second, the reviewing officials must evaluate whether the justification for Ad Seg exists at the time of the review or will exist in the future and consider new relevant evidence as it becomes available. It is inherent in *Hewitt*’s use of the term ‘periodic’ that ongoing Ad Seg reviews may not be frozen in time, forever rehashing information addressed at the inmate’s initial Ad Seg determination.
- “Third and finally, . . . confinement that began for proper Ad Seg purposes may not morph into confinement that persists for improper purposes. . . . The state may not use Ad Seg as a charade in the name of prison security to mask indefinite punishment for past transgressions.”

Id. at 610-11.

In attempting to define what “meaningful” periodic review is, the Second Circuit in *Proctor* undertook what the U.S. Supreme Court and other circuits have failed to do. As Fred Cohen observed prior to the *Proctor* decision, “Left alone, ‘meaningful’ occupies the same verbal pew as ‘inappropriate,’ ‘reasonable,’ and ‘likely.’” Cohen, 2015, p. 74.

A Critique and a Proposal

To date only one commentator, law professor Angela A. Allen-Bell, has provided a detailed answer to the following question: With specificity, describe the reforms needed to ensure meaningful periodic reviews?

Allen-Bell argues that a particular management style—“perception profiling”—has led to overuse of long-term

See FROM THE LITERATURE, next page

FROM THE LITERATURE, from page 27

solitary confinement. Allen-Bell, 2012, p. 818. Regrettably, she fails to advance a precise definition of perception profiling, a concept that Google conflates with racial profiling and is foreign to the legal literature. Fortunately, Allen-Bell indirectly offers a working, contextual definition of perception profiling when faulting “[p]lacement in solitary confinement as a result of perceptions that are not incident to actual actions or specific, actual, and legitimate security or penological concerns. Continued placement in solitary confinement based on dated security concerns should not be allowed.” Allen-Bell, 2012, p. 811.

To illustrate perception profiling, Allen-Bell presented the following interview with the warden of Louisiana State Penitentiary about the continuing segregation of an inmate of color suspected of killing a fellow inmate:

Q. What is it about [inmate] Albert Woodfox that gives you such concern?

A. The thing about him is that he wants to demonstrate. He wants to organize. He wants to be defiant.

Q. Well, let me ask you this. Let's just for the sake of argument assume, if you can, that he is not guilty of the murder of [officer] Brent Miller.

A. Okay. I would still keep him in [solitary]. I still know he has a propensity for violence. I still know that he is still trying to practice Black Pantherism, and I still would not want him walking around my prison because he would organize the young new inmates. I would have me all kind of problems, more than I could stand, and I would have the [whites] chasing after them. I would have chaos and conflict, and I believe that. He has to stay in a cell while he's at Angola.”

Allen-Bell, 2012, pp. 777-78.

Allen-Bell argues that perception profiling dates back to the FBI's counterintelligence program directed at Black Nationalist groups of the 1960s. “Much like the thinking of some prison administrators,” she writes, “[t]he unexpressed major premise of the program was that a law enforcement agency has the duty to do whatever necessary to combat perceived threats to the existing social and political order.” Allen-Bell, 2012, p. 780 n.168, in part quoting from a Select U.S. Senate

Commission

Allen-Bell contends that when correctional administrators assign inmates to solitary confinement on the basis of mistake-prone perception profiling they engage in *de facto* resentencing and thus undermine the Separation of Powers Doctrine in the U.S. Constitution. She reaches this conclusion through the following syllogism. Her major premise is *dicta* in **Williams v. Edwards**, 547 F.2d 1206, 1214 (5th Cir. 1977), that “[i]t is the obligation of penitentiary officials to ensure that inmates are not subjected to any punishment beyond that which is necessary for the orderly administration of [the prison].” Allen-Bell, 2012, p. 804. She then proceeds to her minor premise and conclusion, stating, “When prison officials impose pretextual and/or extreme and prolonged disciplinary or administrative measures that are not absolutely necessary for prison security purposes or genuinely connected to legitimate penological concerns, the prison official leaves the realm of discipline and enters the realm of sentencing/resentencing. In doing so, prison officials not only abuse their authority, but they assume authority they lack.” Allen-Bell, 2012, p. 804.

This controversial and arguably overly formalistic distinction between the proper roles of correctional administrators and judges under the Separation of Powers Doctrine should not overshadow Allen-Bell's most important and pragmatic contribution—how to restructure periodic reviews.

Allen-Bell sets forth the following guidelines for remaking periodic reviews:

- a. Substantively, the inmate had the opportunity to show that no credible continuing and serious threat to the security of others or to the prisoner's own safety exists.
- b. A sincere effort was made at determining if the inmate satisfied or genuinely attempted to satisfy the case plan.
- c. The current punishment is connected to a current security concern and not a dated one.
- d. The current punishment is connected to a legitimate security threat and not a perceived one.
- e. The decision was made upon a showing of a preponderance of actual evidence establishing that the prisoner poses a credible continuing and serious threat to the security of others or to the prisoner's own safety.”

Allen-Bell, 2012, p. 816.

Allen-Bell's rethinking of the process due in periodic reviews finds confirmation in a later, compellingly argued law review article by student author Elli Marcus. “To take seriously the **Hewitt** Court's instruction that segregation must not be a ‘pretext for indefinite confinement,’” writes Marcus, “courts must also investigate the review process for an inmate's return to the general prison population.” Marcus, 2015, p. 1195. Marcus argues that this investigation begins with rebalancing the **Mathews** factors, which, as discussed earlier, was invoked by both the **Hewitt** and **Wilkinson** Courts. This time around, however, deference to staff's security concerns should be expunged from the balancing process in favor of requiring factual proof, which, Marcus argues, can only emerge from “a formal, adversary style hearing.” Marcus, 2015, p. 119.

Conclusion

In light of current state of periodic reviews as presented by Allen-Bell and the Time-in-Cell Report, rethinking the “process due” in this critical component of prison management is well overdue. ■

End Notes

1. In summary form, Robertson, 1987, p. 116, described the procedural rights accorded by Wolff, 418 U.S. 539, 562-70, as follows:

(1) to receive written notice of the impending action; (2) to appear personally at a hearing convened to assess evidence; (3) to receive a lay person's assistance when the affected inmate could not read or faced complex issues; (4) to present documentary evidence and to call witnesses unless prison security would be jeopardized; and (5) to receive a written statement of reasons and their evidentiary basis if the decision makers ruled in favor of segregation.

2. The Second Circuit in **Proctor**, 846 F.3d at 601-02, described the periodic review process as follows:

First, a committee commonly referred to as the “Facility Committee,” consisting of a representative of the facility executive staff, a security supervisor, and a member of the guidance and counseling staff, convenes to review the inmate's institutional record. The Facility Committee prepares and submits to the superintendent of the prison a report outlining “(i) reasons why the inmate was initially determined to be appropriate for [Ad Seg] [i.e., administrative segregation]; (ii) information on the inmate's subsequent behavior and attitude; and (iii) any other factors that [the committee] believe[s] may favor retaining the inmate in or releasing the inmate from [Ad Seg],” and recommending whether to continue the inmate's SHU term.

DOUG KOEBERNICK
Inspector General

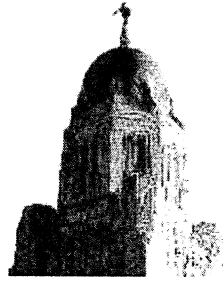

H

STATE OF NEBRASKA
OFFICE OF INSPECTOR GENERAL OF CORRECTIONS
State Capitol, P.O. Box 94604
Lincoln, Nebraska 68509-4604
402-471-4215

Memorandum

To: Judiciary Committee
From: Doug Koebernick, Office of Inspector General
Re: Nebraska State Penitentiary Update
Date: August 18, 2019

Last fall, I submitted a special report on the Nebraska State Penitentiary (NSP).¹ The report provided specific information on the growing challenges at NSP as well as recommendations to address some of those challenges.

On July 10, 2019 I sent an email to the Judiciary Committee regarding NSP after it was reported in the media that the facility was extremely short of staff and had to cancel visitation. I shared with you then that I had learned from a staff member that there other parts of the prison that had to be closed as well. In my email I also informed you that I had attempted to visit NSP the morning of July 10th but NSP was so short of staff that they did not have an extra staff member to escort me around the facility. My purpose in going to NSP that morning was to visit with inmates and staff and gain a better understanding of the “temperature” of the facility. I did not want to add an additional burden to the NSP staff so I left after learning about the escort issue. I then shared with you that I had significant concerns about the staffing at NSP and how it was potentially impacting the operation of the facility.

The purpose of this memo is to follow-up on that July 10th email to you (and two additional emails that I sent to you in July). I have learned a great deal more since that day about NSP and the staffing challenges at the facility, as well as other specific concerns, some of which may be impacted by the staffing challenges.

I should also share that due to these concerns I sent an email to Governor Ricketts’ office on July 18, 2019 that said the following:

“I’ve spent some time talking to individuals connected to the Nebraska State Penitentiary and thought I would share with you that I have some serious concerns about the stability of

¹ The report can be found online at [https://nebraskalegislature.gov/FloorDocs/105/PDF/Agencies/Inspector General of the Nebraska Correctional System/679_20181011-082108.pdf](https://nebraskalegislature.gov/FloorDocs/105/PDF/Agencies/Inspector%20General%20of%20the%20Nebraska%20Correctional%20System/679_20181011-082108.pdf)

that facility. The issues raised with me are alarming and that facility may be in the worst shape of all of our facilities. Please let me know if you or anyone in your office would like to meet about the concerns that have been expressed to me."

I received a response directing me to share my concerns with Director Frakes on July 23, 2019. I discussed those concerns with Director Frakes via telephone shortly thereafter.

At the time of this email my concerns were based on conversations with those who work or reside at NSP as well as observations made during my visits. Since that time, I have visited NSP several times. I have also gained access to additional information and data regarding the staffing of the facility. After receiving and reviewing this data, I became even more concerned and thought it was vital that I share this information with Nebraska's policy makers.

CONTRABAND

In the 2018 special report, issues related to drugs, weapons and cell phones (contraband) were shared. These are still ongoing safety and security concerns. More data on those contraband items will be shared in my 2019 annual report that will be released next month. However, it should be noted that cell phone availability and K2 usage are rather substantial and continue to negatively impact the operations of NSP.² In the past week, there has been many cases of inmates using K2, resulting in unsafe conditions for themselves and those around them. This accessibility to various drugs is a concern, especially since NSP houses the Department's largest substance abuse treatment unit. Many staff and inmates have informed me that the number of cell phones that inmates have access to is quite significant as well.³

STAFFING LEVELS

NDCS has three different levels of staffing at each facility. The three levels are full staffing, minimum staffing and critical staffing.⁴ When a facility operates below a minimum staffing level they can submit a report that provides details on the timing of this level of staffing as well as the impact. When the facility operates at or below a critical staffing level they can submit a similar report.

Upon reviewing NDCS records, it has been learned that since early July 2019, NSP has had at least 18 occasions during which they operated at or below a critical staffing level. During one week in August 2019 NSP also operated below the minimum staffing level on at least six occasions.

When these occasions take place, the entire facility may be impacted. In reviewing the reports that were submitted, it was not uncommon to have the library, gymnasium and the school closed. Visitation was also impacted and specific units had their movement impacted [Housing Unit 4 (a restrictive housing and closed custody unit) was mentioned more than once]. On more than occasion

² It should be noted here that not all of the contraband that is discovered is accounted for by NSP staff. For instance, contraband that is thrown over the walls is not counted in the data reported by the facility to NDCS. Earlier this year, Director Frakes discussed in a public hearing contraband that entered through the outside laundry. This was not accounted for in NSP data. The OIG tried multiple times to receive that data from the Nebraska State Patrol and the Department and was unsuccessful in doing so.

³ It should be noted that data provided to the OIG in a NDCS report shows a significant decrease in the discovery of cell phones during the first half of 2019 at NSP. It is possible that low staffing levels impact the quality of searches which leads to contraband going undetected.

⁴ Positions covered under these definitions include correctional officers, corporals, sergeants, shift supervisors, assistant shift supervisors and caseworkers.

nearly entire shifts of protective services staff were held over and had to work overtime. At times nearly half of a shift included individuals who were working overtime. It appears as though staff regularly volunteer from other positions to fill security positions as well.

Last week, while Senator Lathrop and I were both attending a peer support specialist graduation ceremony in the administrative building, the situation was much different within the rest of the facility. A report indicated that all available first shift staff were mandated to stay and the staffing level was still below the minimum staffing level.

The reports submitted on these occasions provide a great deal of detail on the impact of these low staffing levels. Specific details will not be provided in this memorandum but the contents of these reports undoubtedly increased my level of concern.

STAFF DISCIPLINE

Staff can be disciplined for various actions. When this is done they receive a statement of charges. In recent reports provided to my office, NSP's employee statements of charges were said to be primarily due to staff not working mandatory overtime or abandoning their posts.

PROTECTIVE CUSTODY

One sign of an unstable facility environment may be the number of inmates who request protective custody. NSP has had the highest number of individuals requesting protective custody. In May 2019, 31 individuals requested protective custody, which as a 12-month high. This is about three times higher than the number at the Tecumseh State Correctional Institute (TSCI) and six times more than the number at the Lincoln Correctional Center (LCC) during that same month. So far this month, 18 individuals have requested protective custody at NSP and only four have done so at TSCI.

VACANCIES

Over the last four years, vacancy data has been difficult to accurately measure at times due to the way it is reported. However, using updated data recently provided by NDCS, the chart below was created to show the changes in vacancies for protective services positions at NSP over the last two years. The number of vacancies varies from month to month but there has been a substantive increase in the past two years as the most recent data from June 2019 shows that there were 77 vacancies for those positions. This is the highest total in the last two years.

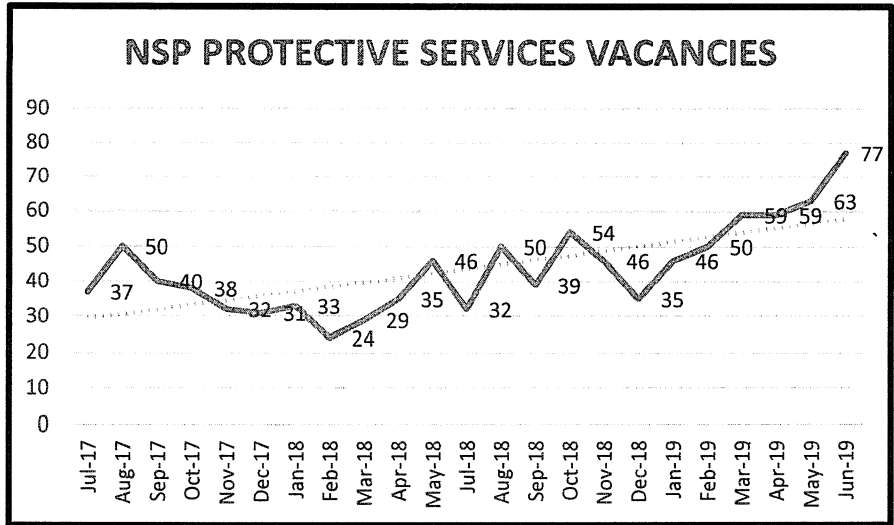

The Department's data for all of the facilities has also increased during that time, as it was at 132 vacant positions in July 2017 and was at 228 vacant positions in June 2019. Much of this increase was driven by NSP, the Lincoln Correctional Center and the Omaha Correctional Center staff who are assigned to work at the Tecumseh State Correctional Institute.

According to a report provided by NDCS, overall staff vacancies at NSP increased from 68 in June 2018 to 92 in May 2019. It is important that this data continually be analyzed and tracked to see if additional trends develop.

OVERTIME

The data that may demonstrate the highest level of concern is staff overtime hours. Overall, the amount of overtime served by the protective services employees in all of the facilities has reached record highs (with the exception of May 2015 when the first Tecumseh riot took place). The chart below compares the data for 2017, 2018 and the first six months of 2019. So far each month in 2019 has exceeded the corresponding months for 2017 and 2018. This growth, as measured in average monthly overtime hours, is displayed in the second chart.

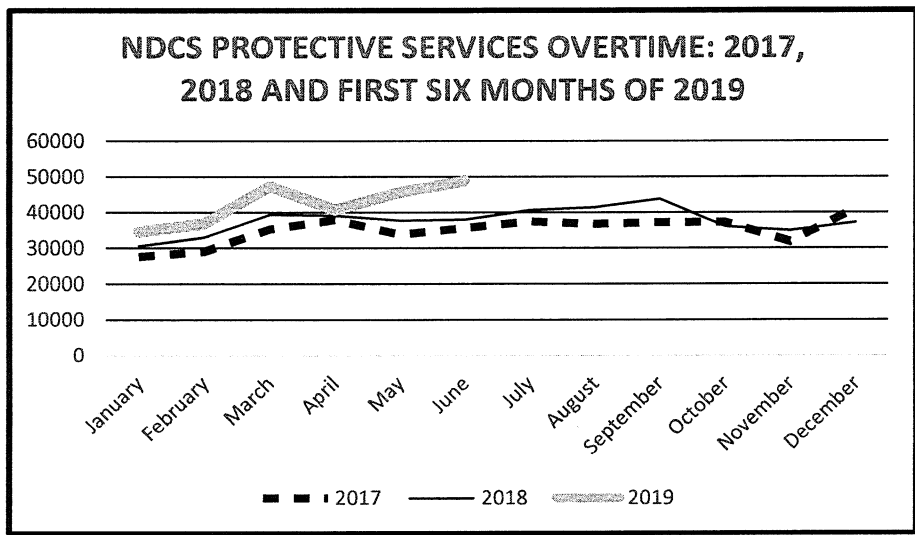

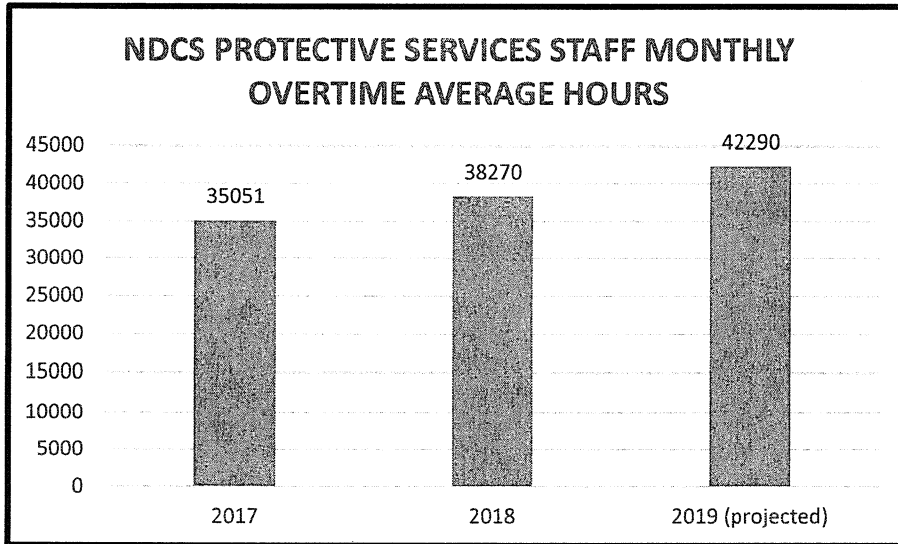

The primary driver of the increase in overtime of the Department is NSP. Below are four charts that demonstrate significant increases in overtime at NSP. The first chart is the overtime hours for protective services employees since January 2018. There is a significant increase in the last few months.

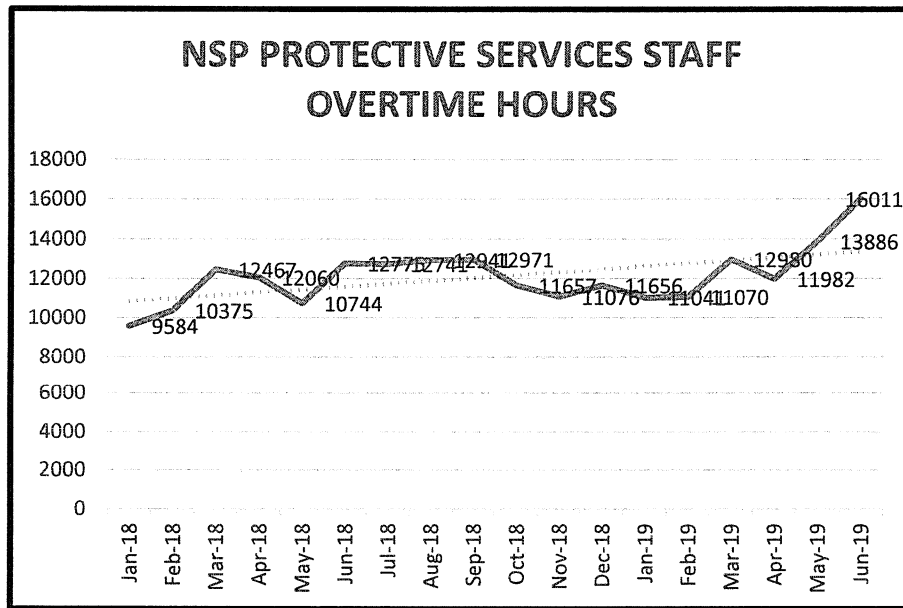

The second chart shows the changes in overtime hours of non-protective services employees at NSP since January 2018.

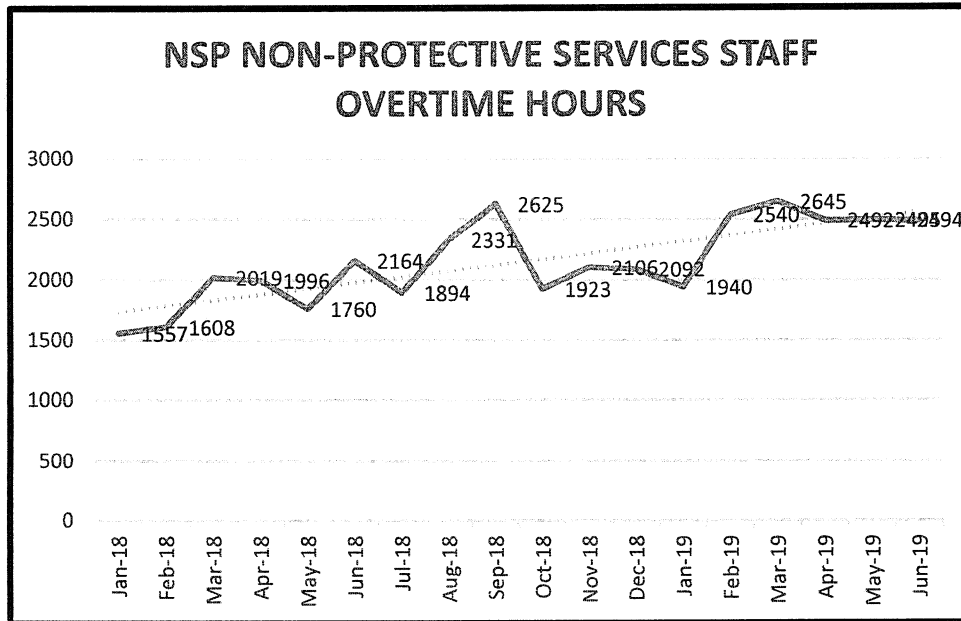

The third chart shows the combined overtime hours of both types of staff at NSP since January 2018.

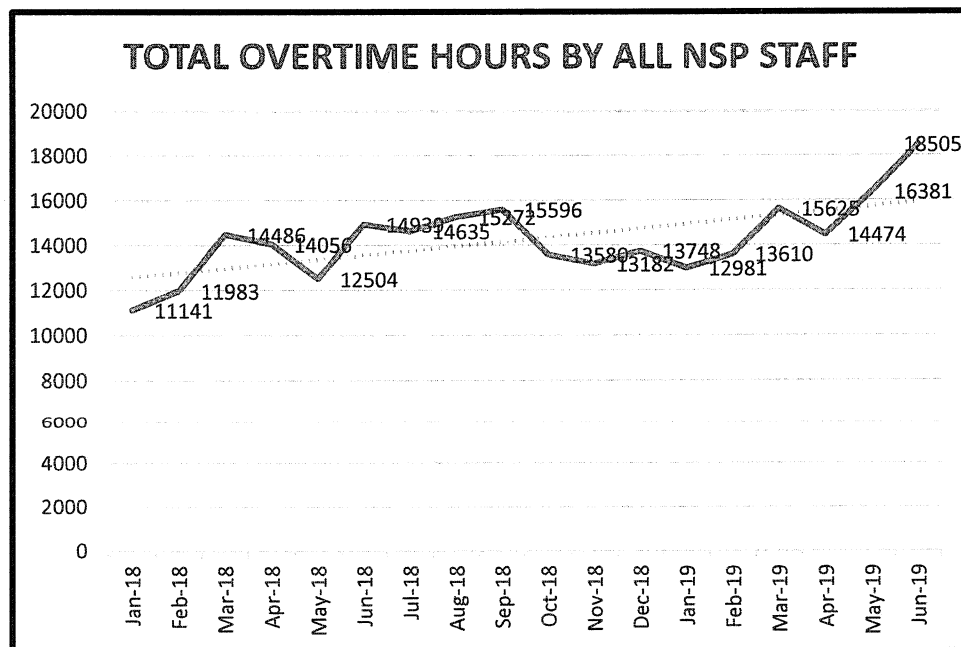

The fourth chart goes back further and shows the amount of overtime hours for protective services employees at NSP since January 2014.

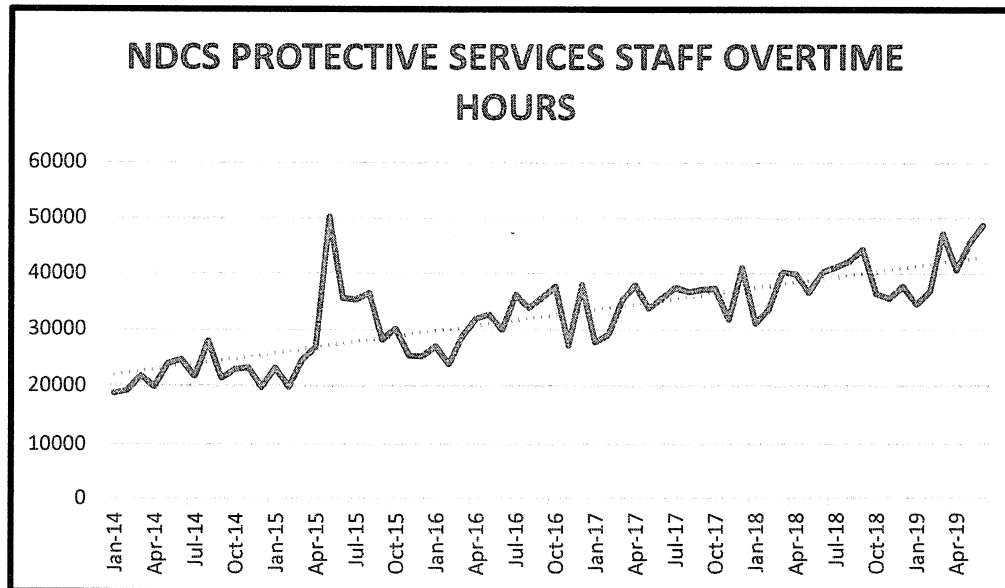

The recent growth in overtime is alarming, especially as it comes on top of continual growth since 2014 in overtime hours at NSP and in the Department. One of the items that is not captured in these charts is the amount of overtime served at NSP by staff from other facilities. If someone comes from another facility to work at NSP, that overtime is counted as overtime at their facility. The Department uses various means to encourage staff from other facilities to assist at facilities in need of staff, including providing transportation, lodging and meals for those who work two or more days at one of the shortage facilities.

SUMMARY

As has been stated many times in the last few years, the Department continues to face a troubling staffing issue. The two facilities facing the most significant problems are NSP and the Tecumseh State Correctional Institute (TSCI). Several of the items discussed about NSP may also apply to TSCI. However, when one factors in the overcrowding at NSP (NSP typically operates at over 180% of its design capacity and TSCI typically operates at 105% of its design capacity) plus the significant presence of contraband as compared to TSCI's lower level of contraband, NSP has emerged as a potentially more troubled facility. As previously shared, staff and inmates have shared numerous stories and opinions with me during the past few months. These comments plus the data presented in this memorandum are quite disturbing. In addition, NSP will have a 100 bed housing unit being built within its walls during the next year. Staff have shared their concerns that during this project staff will be needed to assist with the contractors yet currently they have no extra staff. Once it is built it will also require additional staff to operate the unit. Staff and inmates have also contacted my office due to concerns about the timeliness and quality of medical care that has resulted from low staffing levels.

I have shared this information with you (this and more will be in my annual report in September) because I think it is vital that you know about these concerns. It is also important to know that these concerns are not ones that are being voiced solely by myself. The Ombudsman's office, the FOP and NAPE union members, inmates and others involved in the system have also expressed these concerns or had discussions about these concerns. In the recent past, the Department has started to implement a number of proposals to attempt to address staffing challenges (changes in salary,

merit/longevity pay, bonuses, leadership academies, Gallup initiative and others). It remains to be seen how impactful these efforts will be but they are positive steps. It is also important to note that these staffing issues impact more than just staff, the inmates and the operations of the facility. They also can impact staff's families and others as they create a great deal of uncertainty and stress for those individuals and their lives outside of the Department.

In the meantime, I would encourage you to visit with Director Frakes or facility wardens, make visits to NSP or other facilities or meet with the FOP and NAPE staff members (and any other staff members for that matter) to learn more about the situation at NSP (and any other facilities that you would like to learn more about). If you would like to discuss this situation with me please let me know as I am always willing to meet with you.

Separate incidents put unit on modified operations at State Penitentiary

AUGUST 24, 2019

FOR IMMEDIATE RELEASE (19-46)

CONTACT Laura Strimple, Chief of Staff

OFFICE 402-479-5713 | laura.strimple@nebraska.gov

August 24, 2019 (Lincoln, Neb.) – A housing unit at the Nebraska State Penitentiary has been placed on modified operations* due to separate incidents involving multiple inmates.

This afternoon, an inmate was assaulted by several inmates in his cell resulting in serious injuries, including a fractured jaw. He was transported to a local hospital for treatment. Additionally, 11 inmates, also in the same housing unit, were assessed and treated by medical staff at the penitentiary for being under the influence of K2 (commonly referred to as synthetic marijuana).

The assault on the inmate is currently under investigation. Findings will be presented to the county attorney for determination of criminal prosecution. The NDCS disciplinary process will be utilized with sanctions, such as the loss of good time, applied according to the rules and regulations. Aside from the affected housing unit, the rest of the Nebraska State Penitentiary remains on normal operations.

###

*Modified operations is defined as, actions taken to more closely control movement of inmates within a facility due to safety and security needs. Can include confinement in cells of a portion of the inmate population, cancellation of program/work activities, and direct escort of certain inmates – as determined by the warden/designee

FACILITIES: Nebraska State Penitentiary

DOUG KOEBERNICK
Inspector General

J

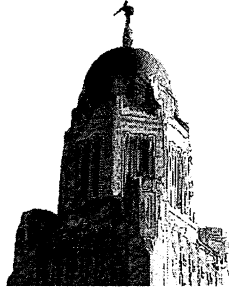

STATE OF NEBRASKA
OFFICE OF INSPECTOR GENERAL OF CORRECTIONS
State Capitol, P.O. Box 94604
Lincoln, Nebraska 68509-4604
402-471-4215

August 29, 2018

Scott Frakes, Director
Nebraska Department of Correctional Services
801 West Prospector Place
Lincoln, NE 68522

Dear Director Frakes:

Later this year the contract with Vantage for the STRONG-R expires. I have spent some time looking into this issue and recently asked Deputy Director Spindler when the new Request for Proposal will be issued so others can bid on this need of NDCS. She indicated that it is likely that the contract will be renewed for another three years.

Conversations with many in the Department have resulted in my learning about the drawbacks of the STRONG-R. Many of your staff have reservations about the continued use of it. I have been informed that an internal NDCS group that works on this issue recently voted to not renew the contract with STRONG-R and to discontinue the use of the STRONG-R at the end of this year.

There are other tools available for the Department to use that are similar to the STRONG-R. Opening the process to other bidders would not only provide the Department with options, in addition to the STRONG-R, but may also result in the potential for a significant cost savings. It is my understanding that the Office of Parole Administration paid \$32,000 in up-front costs for the ORAS and is now paying \$20,000 per year for the tool. Meanwhile the STRONG-R initial costs were \$476,200 for three years. Additions to that original contract have resulted in the cost increasing to \$621,032 according to the DAS web site. Parole is paying \$92,000 for three years of the ORAS and NDCS is paying nearly seven times that for the STRONG-R. This would be a cost savings of over \$500,000.

A recent story in the Lincoln Journal-Star discussed the need for an open and fair bidding process for state contracts and the issues that can be associated with renewing contracts without open competition. I would urge you to issue a Request for Proposal for this service. If Vantage has the best product they can go through the process and make their case. If others believe they can provide a better service let them make their case. Having an open and transparent bidding

process for this important task within NDCS would show that NDCS wants the best products and the best service at the best price.

Thank you for your consideration. If you have any questions regarding my letter please let me know. I have attached a copy of the story from the Lincoln Journal-Star to this letter.

Sincerely,



Doug Koebernick

https://journalstar.com/news/state-and-regional/govt-and-politics/is-nebraska-open-for-business-companies-say-state-s-bidding/article_a9562ab4-5960-5bc5-a64b-27dcb520da27.html



Is Nebraska open for business? Companies say state's bidding process flawed

CHRIS DUNKER Lincoln Journal Star Aug 26, 2018 Updated Aug 27, 2018

SUBSCRIBE FOR 33¢ / DAY



2017 top-dollar projects awarded without bidding

Nebraska state agencies requested deviations from the standard procurement processes on 83 projects in 2017. The state ultimately awarded 34 of those projects for a total of \$211 million. Here are the top awards.

Department	Vendor	Justification by state agency	Contract Cost
Health and Human Services	Nebraska Families Collaborative	HHS officials cited "insufficient time" to issue a new request for proposal to continue case management for the state's child welfare program after rejecting two other proposals.	\$143,000,000
Labor	Geographic Solutions	Purchasing a new service from Geographic Solutions would allow the labor department to align six other contracts for a common end date.	\$34,701,741
Administrative Services	KPMG	KPMG offers General Services Administration-like pricing and is a partner of Oracle, which is helping the state to move IT operations to a cloud service, according to DAS.	\$9,300,000
Health and Human Services	JS3 Consulting	"Due to factors beyond the state's control," HHS said several Medicaid projects were still being developed past a deadline, requiring an emergency extension of JS3's consulting services.	\$7,500,000
Health and Human Services	Blue Cross Blue Shield of Nebraska	A prior contract with Blue Cross Blue Shield for medical billing to the Lincoln and Norfolk regional centers "cannot continue." An emergency contract was enacted while HHS prepares a new RFP.	\$2,584,564
Health and Human Services	Enterprise Services LLC	"Any new vendor would have to incur additional costs" being brought up to speed on maintaining and supporting HHS' electronic immunization information system.	\$2,045,927
Health and Human Services	TALX Corporation	"If this contract were bid out, we believe TALX would be the only company whose bid would be able to address our service requirements" for processing SNAP benefits.	\$2,036,733
Health and Human Services	Netsmart	As HHS develops a new request for proposal for an electronic health records system to serve the three regional centers and BSDC, it needed to keep its maintenance agreement with the current provider.	\$1,268,153
State Patrol	Southwest Solutions Group	"Digital scanning of criminal files must be performed on-site. Southwest Solutions is the only vendor willing to perform this project on site and attend a pre-proposal meeting."	\$662,614
Health and Human Services	Solutran	Solutran has provided WIC check processing for Nebraska for 19 years and is the only vendor who can perform the service "without additional cost and system changes."	\$525,000

BUY NOW

For months in 2017, On Point Technology prepared to answer the Nebraska Department of Labor's call to upgrade the state's aging and outdated unemployment insurance systems.

Custom-built in an old programming language, Nebraska's unemployment insurance systems were clunky, "impossible to maintain properly," and incapable of integrating with the state's workforce development offerings, said Labor Commissioner John Albin.

As architect of nearly half the state unemployment insurance systems in the U.S., On Point arranged two demonstrations of its flagship product for Nebraska officials and later confirmed its Oak Brook, Illinois, mailing address to the state's Labor Department as a request for proposal was being finalized.

But after a successful set of demonstrations, and the conversation about where to send the RFP, the Labor Department fell silent.

By August, On Point had still not received an RFP, the company's attorney explained in a letter to Albin and Doug Wilken, then-interim administrator of the state Department of Administrative Services' purchasing division, despite a positive response to the demonstrations of its software.

It was only then that state officials "finally informed On Point that NDOL had canceled the planned RFP," On Point wrote, awarding the \$34.7 million contract to a competitor, Geographic Solutions Inc., without going through the state's competitive bidding process.

State officials "finally informed On Point that NDOL had canceled the planned RFP," On Point wrote, awarding the \$34.7 million contract to a competitor, Geographic Solutions Inc., without going through the state's competitive bidding process.

The contract was signed by Bo Botelho, materiel administrator of the Department of Administrative Services at the time, on June 15, one day after On Point had confirmed its mailing address with the Labor Department.

On Point contested the no-bid contract awarded to Geographic Solutions, alleging it violated state statute and procurement policy while undermining "the fundamental principles of any accountable public procurement system."

In the protest letter to Albin and Wilken, Scott Schipma, an attorney for On Point, said Nebraska state law only allows "the use of sole source or 'no-bid' contracts to circumstances where there is clearly only one practicable source to provide the service in question."

Schipma also wrote the Labor Department had violated federal procurement law in not bidding the project funded through federal tax dollars.

Other companies in addition to On Point hoped to bid for the chance to build unemployment insurance systems for Nebraska, including the Minnesota-based Sagitec Solutions, and Fast Enterprises, a Colorado company, both of whom have decades of expertise in the field.

The state rejected On Point's protest in an Aug. 28, 2017, letter, however, saying protests were only acceptable from companies that have submitted unsuccessful bids.

“As this contract was not bid we cannot accept your letter as a valid protest,” Wilken responded to Schipma.

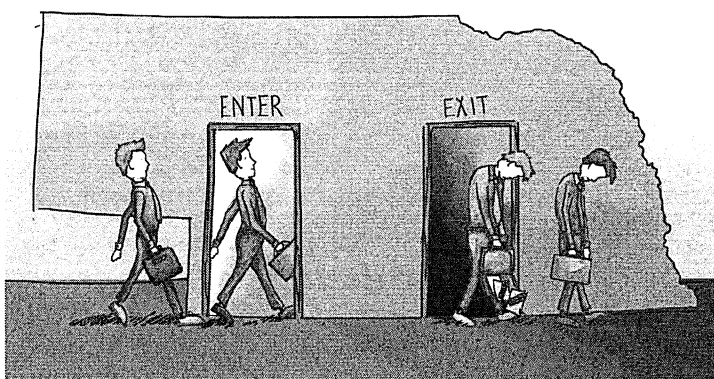

History with Geographic Solutions

Nebraska has entered into several sole source contracts with Geographic Solutions after the Florida company first won the bid to develop the state's NEworks labor exchange and labor market system in 2010.

After that first contract, Nebraska added Geographic Solutions' mobile application, its Spanish-language version and three other software products, each time through a deviation of the standard bidding process.

Albin said once Geographic Solutions proved itself with NEworks, it made sense to continue expanding its Virtual OneStop system by adding more modules to it.

If you owned a Chevrolet, you wouldn't modify it with Ford parts, Albin said.

"It is pretty much the same way with software systems," he said. "Once you have bought a proprietary software system, you are pretty much committed to using that vendor's product and enhancements unless and until you replace it with a new system."

Labor Department officials began identifying the requirements for a new unemployment insurance tax and benefits system in late 2016 and early 2017 as they prepared an RFP, working with state purchasing officials as well as IT specialists on determining the state's needs.

But when they sought permission to contract with Geographic Solutions in January 2017, Brenda Pape, the state procurement manager, told the Labor Department it needed to competitively bid the project.



Nebraska Labor Commissioner John Albin

Courtesy photo

"It would be impossible to defend a sole source," Pape wrote in a Jan. 27, 2017, email to several Labor Department staff members. "We would have other vendors who would come forward to say they could have done the same thing at a lesser cost."

Paul Toomey, the president and founder of Geographic Solutions, described the Virtual OneStop system as a complete system bridging the two primary missions of most labor departments.

"Our integrated system is kind of a revolutionary concept," he said. "The (unemployment insurance) is simply a module of the workforce system."

Albin said the Labor Department had not effectively communicated that point, as well as the complexities of the state's system, to procurement officials before the January 2017 response.

The department sought the input of Ed Toner, the state's chief information officer, who had overseen the migration of the state's NEworks system off of state-run computer servers to a server hosted by Geographic Solutions in 2014.

Toner, a former IT executive at TD Ameritrade and First Data in Omaha, said in a sworn affidavit responding to On Point's protest that he backed the Labor Department's plan for a sole source contract with Geographic Solutions to unlock the full potential of the system.

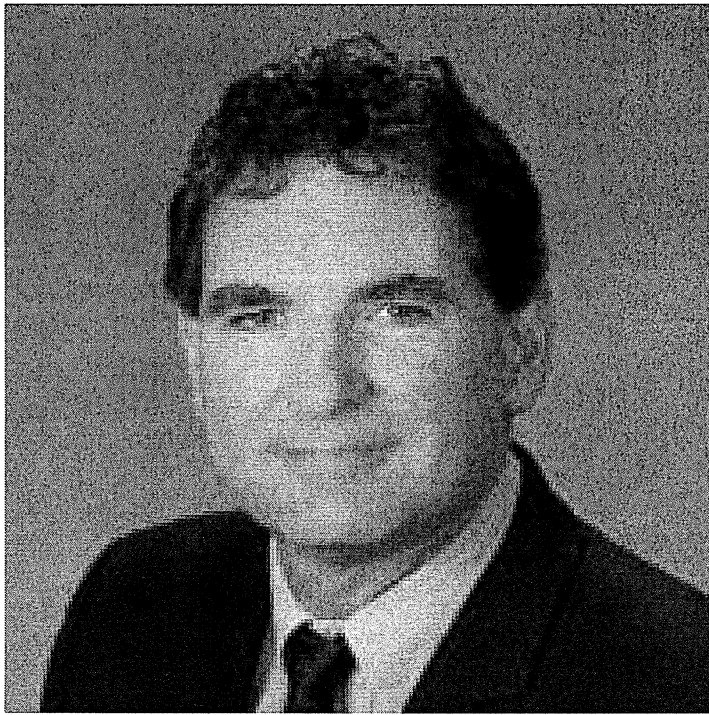

Nebraska chief information officer

Courtesy photo

Issues are more challenging to identify when systems are spread across multiple vendors, Toner wrote, while testing for bugs is more difficult and deadlines are tougher to meet when the state is required to work with multiple companies on a project.

"When first approached by NDOL regarding a new unemployment system, it was my recommendation to do a sole source contract with GSI in order to have one platform," Toner said. "There were simply too many platforms already involved in this

instance to conduct a fair bid process that would result in a cost savings for the State of Nebraska."

Packaging all six independent contracts the Labor Department has with Geographic Solutions into one would also allow the state to seek proposals to replace the whole system in the future if necessary, Albin said.

The new consolidated contract expires June 30, 2023.

Tech companies critical

The vendors hoping to work with Nebraska in modernizing its unemployment insurance system said concerns that competing companies would not be able to work together while protecting their intellectual property are unfounded.

On Point, for example, had integrated its unemployment insurance system with the Virtual OneStop system built by Geographic Solutions for the District of Columbia, Schipma wrote in On Point's protest letter.

Sagitec Solutions has built unemployment insurance systems that work with Geographic Solutions' workforce modules in four states, according to David Minkkinen, a partner at the company.

Plus, state officials did not raise any concerns when they met with On Point months before deciding to pursue a sole source contract with Geographic Solutions.

"At no time during the February or March demonstrations" of On Point's unemployment insurance system, Schipma wrote, did "Commissioner Albin or anyone else raise questions or concerns regarding the integration of these On Point solutions with other IT application modules."

On Point CEO Tom Luparello said in a phone interview that Geographic Solutions is best known for its workforce development products used in 25 states and territories. That "commercial off the shelf" software is largely uniform, and features minimal customization options based upon a state's preferences, he said.

Unemployment insurance systems, in contrast, are largely custom-built to comply with both federal guidelines as well as state laws, which dictate how the workers who lose their jobs can collect benefits from the state's unemployment trust fund.

"They all end up being very custom for the state's purposes," Luparello said, "and they have an extremely long life span, historically. Supporting them is very much a niche thing."

Toomey said the off-the-shelf Geographic Solutions system is capable of matching the customization of other vendors, "not just to their laws but to their interpretation of unemployment," he said.

As part of its contract with Nebraska, Geographic Solutions has pledged to update and enhance the system based upon changes to state and federal law, keeping it "evergreen."

But in its protest letter, On Point said Geographic Solutions has struggled with its first few forays into the unemployment insurance market.

In Louisiana, the rollout of the Geographic Solutions Unemployment System — contracted as a sole source provider for that state in 2010 similar to how Nebraska acquired the system — was behind schedule and marked by payment errors, according to a state audit.

When it went live in 2016, information from Louisiana's old system was not properly integrated into the new Geographic Solutions-built Helping Individuals Reach Employment, or HiRE system, immediately resulting in claimants being overpaid or underpaid, and leaving the state unable to correct the errors, the state auditor found.

Albin said the Labor Department will rigorously test the new system to ensure it's ready before going live. He holds the ultimate "go, or no go" authority on the project.

Similarly, the second system built by Geographic Solutions for Tennessee was implemented "in the face of known deficiencies, including unresolved testing errors, insufficient verification of the data conversion process, and inadequate training of staff," according to an audit.

Toomey said Geographic Solutions has fixed both problems, and about 150 employees are working on Nebraska's unemployment insurance system. It's on track for deployment in early 2019.

Albin said the Labor Department will rigorously test the new system to ensure it's ready before going live. He holds the ultimate "go, or no go" authority on the project.

"I'd rather suffer a little bit of embarrassment being late than a lot of embarrassment in a failure," he said in an interview earlier this year.

Several companies, including On Point and Sagitec, said they presented the problems associated with Geographic Solutions systems to Nebraska officials in an effort to get the state to reconsider its decision to pursue a sole source contract.

But Minkkinen, of Sagitec, said they were largely ignored.

Wilken later told On Point the state was confident in its decision to award a sole source contract for the project.

"Based on the information provided to us, it was found the justification provided to us by the Department of Labor met with the requirements for an exception and was in the best interests of the State of Nebraska," Wilken wrote.

Deviations 'the exception'

Nebraska state agencies are required to competitively bid all contracts in excess of \$50,000 according to state law, although there are exceptions.

Services or goods that can only be obtained by a single source, emergency contracts or certain contracts already in place with the General Services Administration can be obtained by agencies that submit deviation requests to the standard bidding process.

State agencies can also latch onto contracts bid by other states, or with a cooperative purchasing organization acting on behalf of a group of states, without needing to bid for that project.

Deviation requests submitted by state agencies must go before the director of the Department of Administrative Services along with a copy of the proposed contract and a written justification for review before they can be approved.

David Zwart, the current Department of Administrative Services materiel administrator, said the number of deviations requested and actually granted represents a small portion "in a year of literally thousands of contracts and tens of thousands of individual purchases by the state."

According to records provided to the Journal Star, 83 deviation requests were submitted by Nebraska state agencies in 2017, totaling \$297 million in requested state and federal tax dollars for no-bid contracts.

The Administrative Services Department signed off on at least 34 of those requests, based upon contracts available on the department's website, awarding nearly \$211 million in deviation requests in the last calendar year.

Most of that figure comes from a single contract: A two-year, \$143 million agreement between the state Department of Health and Human Services and the Nebraska Families Collaborative to continue managing child welfare cases in Douglas and Sarpy counties.

The collaborative, now called PromiseShip, was awarded a new contract in 2017 after the state rejected two other bids, as well as a protest by Magellan Choices for Families, one of the losing bidders, to take over case management. The Department of Health and Human Services justified its deviation request by saying there was "insufficient time to issue a new RFP."

Other states employ similar procedures allowing state agencies to deviate from the standard bidding process, although the rate at which no-bid contracts are awarded varies greatly.

Iowa state agencies submitted a total of nine sole source purchasing requests in the 2016-17 fiscal year, according to a spokeswoman for the Iowa Department of Administrative Services.

The Hawkeye state requires sole source justifications for the purchase of goods costing more than \$1,500, the purchase of services totaling more than \$5,000 and for purchases from small businesses greater than \$10,000.

In South Dakota, only six sole source purchases requested by state agencies were authorized in calendar year 2017, according to Steven Berg, director of the Office of Procurement Management.

But in Kansas, which requires justifications for sole source purchase requests above \$100,000, state officials approved 180 in 2017, said John Milburn, the director of legislative and public affairs in the Kansas Department of Administration.

Wilken said a good number of Nebraska's deviation requests come from state agencies that have had difficulties bidding projects, or need to respond to emergencies by contracting with a new vendor.

“Deviations really are the exception,” he said. “They are put in place because, sometimes, it’s in the best interests of the state to get what it needs other than through an RFP.”

Adding insult to injury

Those shut out of bidding for the state’s business when agencies pursue a no-bid contract say Nebraska’s procurement rules add insult to injury, however.

Companies, particularly large technology firms, say Nebraska’s procurement statutes offer little to no recourse if a state agency chooses not to ask for bids, or if the contract is awarded to "an irresponsible or corrupt vendor."

Thomas Kenny, a partner at Kutak Rock law firm in Omaha, said Nebraska is one of a minority of states that do not allow companies to ask a judge to review the bidding process.

“When you have a flawed process like this, it really discourages companies from wanting to do business in Nebraska,” said Kenny, who has litigated and written on the topic. “Unlike most states, we have not been willing to allow large contract

awards to be reviewed either by an administrative law judge or a judge appointed by the governor.”

Nebraska has already suffered because of its lack of protest review, Kenny said. In 2007, the state awarded a \$50 million annual contract to a small Arizona company to run its Medicaid Management Information Systems.



Thomas Kenny
Courtesy photo

"When you have a flawed process like this, it really discourages companies from wanting to do business in Nebraska."

-- Thomas Kenny, Omaha attorney

Two years later, after Kerry Winterer became CEO of the Department of Health and Human Services, he determined the company could not perform the work for the state it said it could, and he terminated the contract, but not before \$7 million in taxpayer money had been spent.

Allowing companies that have unsuccessfully bid a project to seek a judicial review of the contract could have prevented the state from granting the award to an unqualified company, Winterer told state lawmakers.

It would also protect the state in contracts as large as \$1 billion per year, Kenny said, like the contract signed between HHS and its providers for Nebraska's Heritage Health program.

In both cases, as well as with On Point, the Department of Administrative Services rejected the protests of the unsuccessful companies and pointed to the state's lack of judicial review of these cases, Kenny said.

State Sen. Paul Schumacher of Columbus introduced a bill (LB814) in January that would have required the Administrative Services Department to write new rules allowing for a judicial review of the bidding process.

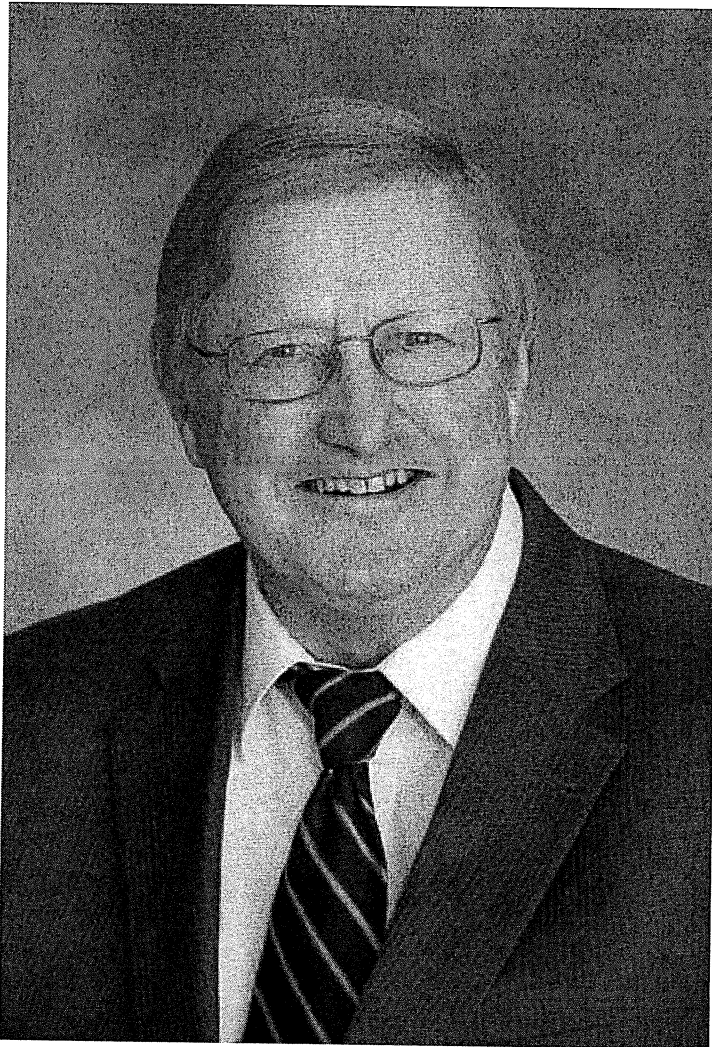

Sen. Paul Schumacher of Columbus

“Right now, there is a lot of discretion and room for arbitrary action by the administration, by the executive,” Schumacher said in a recent phone interview. “There is really no way to appeal that’s effective, other than going to meet with the administrator that’s made the decision and trying to convince them that they’re wrong.”

LB814 was supported by former U.S. Sen. David Karnes, who testified on behalf of the IT Alliance for Public Sector, as well as Winterer, who said judicial review would satisfy private companies seeking to work with the state while also protecting state agencies from mishaps like he experienced in 2007.

Courtesy photo

Wilken testified against LB814 on behalf of the Administrative Services

Department, arguing judicial review of the procurement process could add weeks or months — even years — to the execution of a contract for the state.

Schumacher's bill stalled in the Legislature's Government, Military and Veterans Affairs Committee, but Omaha Sen. Justin Wayne, an attorney who files bid protests on behalf of companies, plans to introduce a similar measure next year as part of a suite of what he called business-friendly legislation.

"Nebraska is often times not large enough to have fierce competition for some of its services," Schumacher said. "And if the state has got a reputation as Nebraska is apparently getting, we are losing out on some really good bids from some really good companies."

Reach the writer at 402-473-7120 or cdunker@journalstar.com.

On Twitter @ChrisDunkerLJS.

MORE INFORMATION

STATE OF NEBRASKA SERVICE CONTRACT AWARD

L

PAGE 1 of 1	ORDER DATE 12/31/15
BUSINESS UNIT 46020855	BUYER CHRIS KLIMENT (DCS)
VENDOR NUMBER: 2372421	Contact: Sean Hosman, Chief Exec. Off. Phone: (801) 295-1385 Cell: (801) 541-5212 Fax: (801) 443-1982 Email: shosman@assessments.com
VENDOR ADDRESS: ALLVEST INFORMATION SERVICES INC DBA VANT4GE PO BOX 1802 SALT LAKE CITY UT 84110-1802	

DEPT OF CORRECTIONAL SERVICES

CONTRACT NUMBER
69908 04 REN 1

Buyer: Chris Kliment
Phone: (402) 479-5718
Fax: (402) 479-5663
Email: chris.kliment@nebraska.gov

AN AWARD HAS BEEN MADE TO THE VENDOR/CONTRACTOR NAMED ABOVE FOR THE SERVICES AS LISTED BELOW FOR THE PERIOD:

JULY 27, 2019 THROUGH JULY 26, 2022

THIS CONTRACT IS NOT AN EXCLUSIVE CONTRACT TO FURNISH THE SERVICES SHOWN BELOW, AND DOES NOT PRECLUDE THE PURCHASE OF SIMILAR SERVICES FROM OTHER SOURCES.

THE STATE RESERVES THE RIGHT TO EXTEND THE PERIOD OF THIS CONTRACT BEYOND THE TERMINATION DATE WHEN MUTUALLY AGREEABLE TO THE VENDOR/CONTRACTOR AND THE STATE OF NEBRASKA.

Original/Bid Document 82500 03

Line	Description	Quantity	Unit of Measure	Unit Price	Extended Price
17	SUITE OF RISK/NEEDS ASS INST YEAR 4	2.0000	\$	80,000.0000	160,000.00
18	SUITE OF RISK/NEEDS ASS INST YEAR 5	2.0000	\$	88,000.0000	176,000.00
19	SUITE OF RISK/NEEDS ASS INST YEAR 6	2.0000	\$	96,800.0000	193,600.00
Total Order					529,600.00

Renewal of contract for three (3) years to provide Suite of Risk/Needs Assessment Instrument, and incorporating Addendum One (1) and Exhibit A. All other terms and conditions remain the same.

Invoices to: NE Department of Correctional Services
Accounts Payable
P.O. Box 94661
Lincoln, NE 68509-4661
Or via e-mail to: DCS.AccountsPayable@nebraska.gov

Accounts Payable Contact (402) 479-5715

Chris Kliment 7/31/19
Kate Swice
AGENCY SIGNATURE

Population and Demographics

Average Daily Population (ADP), by Facility

Facility	ADP	Operational Capacity	% Operational Capacity	Design Capacity	% Design Capacity
CCC-L	545	560	97.25%	460	118.39%
CCC-O	158	135	116.94%	90	175.41%
DEC	520	275	189.16%	160	325.11%
LCC	518	468	110.64%	308	168.11%
NCCW	338	318	106.14%	275	122.74%
NCYF	70	70	100.25%	68	103.20%
NSP	1,366	1,139	119.95%	718	190.29%
OCC	793	666	119.08%	396	200.27%
TSCI	1,012	976	103.70%	960	105.43%
WEC	138	200	69.01%	100	138.02%
Total	5,458	4,807	113.54%	3,535	154.39%

*ADP totals are rounded to the nearest integer

County Jail ADP

County	ADP
Buffalo	12
Dawson	9
Lincoln	19
Phelps	18
Platte	39
Scotts Bluff	4
Total	102

ADP by Gender

Gender	# Inmates
Female	431
Male	5,131
Total	5,562

Average Age

37.32 Years

ADP by Race/Ethnicity

- White
- Black
- Hispanic/Latino
- American/Alaskan Native
- Asian
- Hawaiian/Pacific Islander
- Other
- Data unavailable

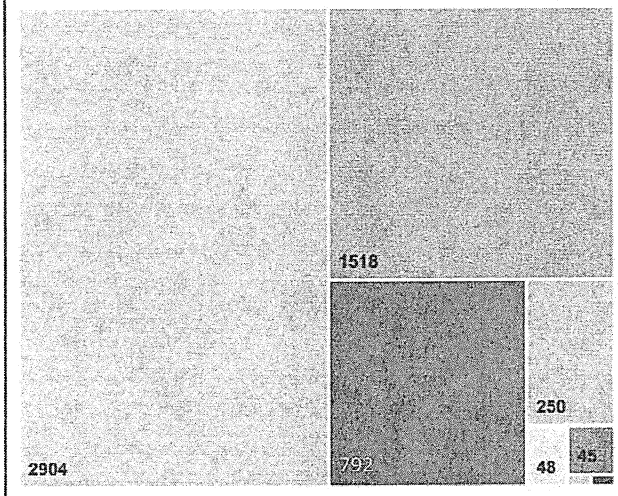

ADP by Classification and Gender

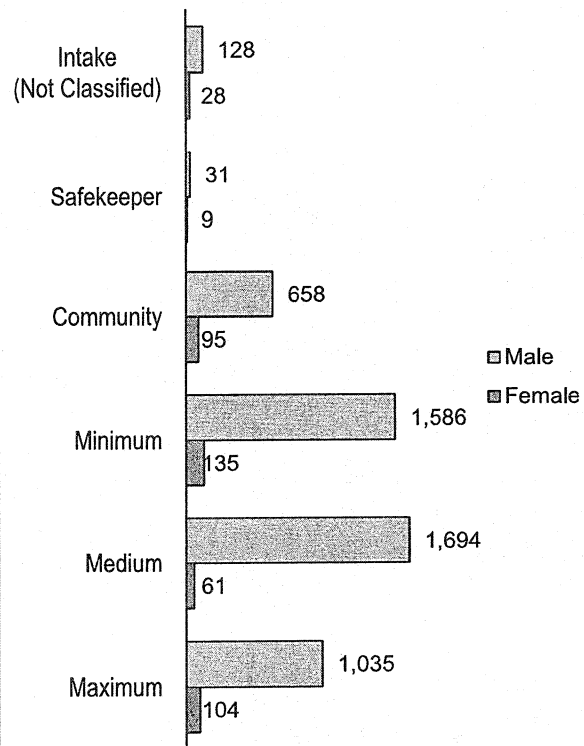

Population and Demographics (cont.)

ADP by Most Serious Offense		
Category	ADP	%
Homicide	579	10.42%
Sex Offenses	1077	19.37%
Assault	1130	20.32%
Robbery	346	6.22%
Weapons	568	10.22%
Restraint	21	0.38%
Arson	24	0.43%
Drugs	848	15.26%
Burglary	213	3.83%
Theft	272	4.89%
Motor Vehicle	260	4.67%
Fraud	53	0.95%
Morals	14	0.25%
Other	115	2.07%
Safekeepers	40	0.72%
Total	5,560	100%

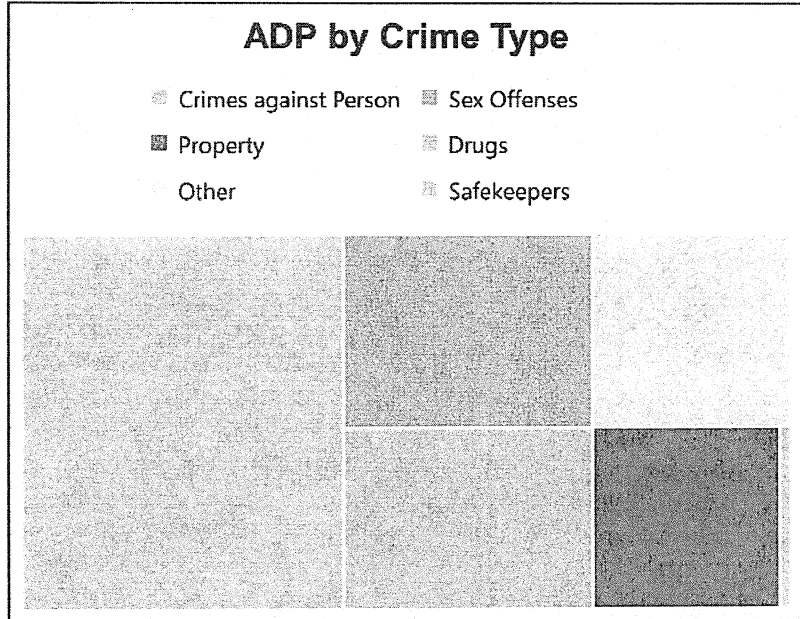

The small green box in the "ADP by Crime Type" graphic represents safekeepers.

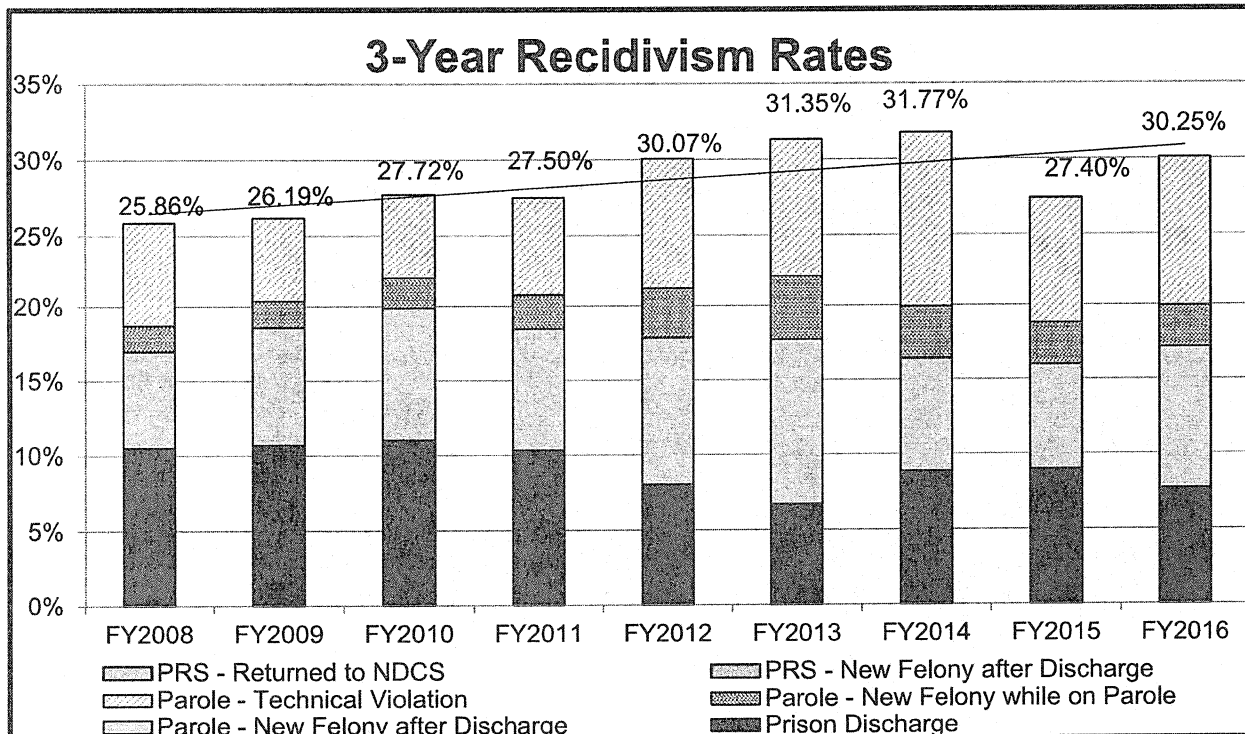

"Recidivism" is defined as a return to NDCS custody as the result of a parole revocation or an admission on a new sentence within three years of a person's release from prison.

Reentry and Discharge

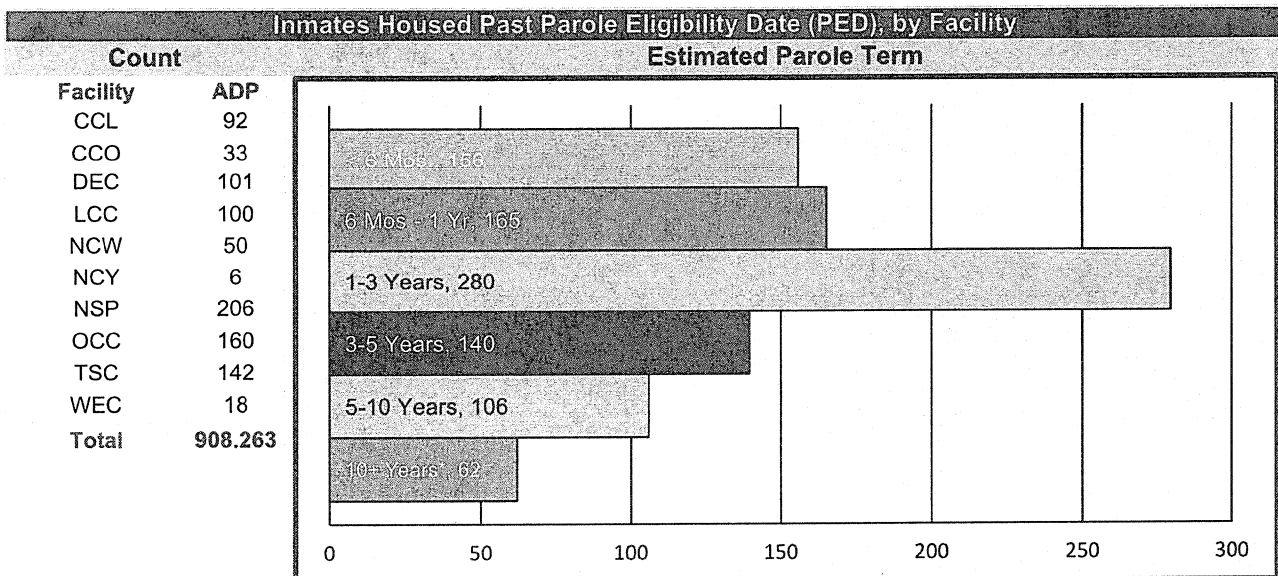
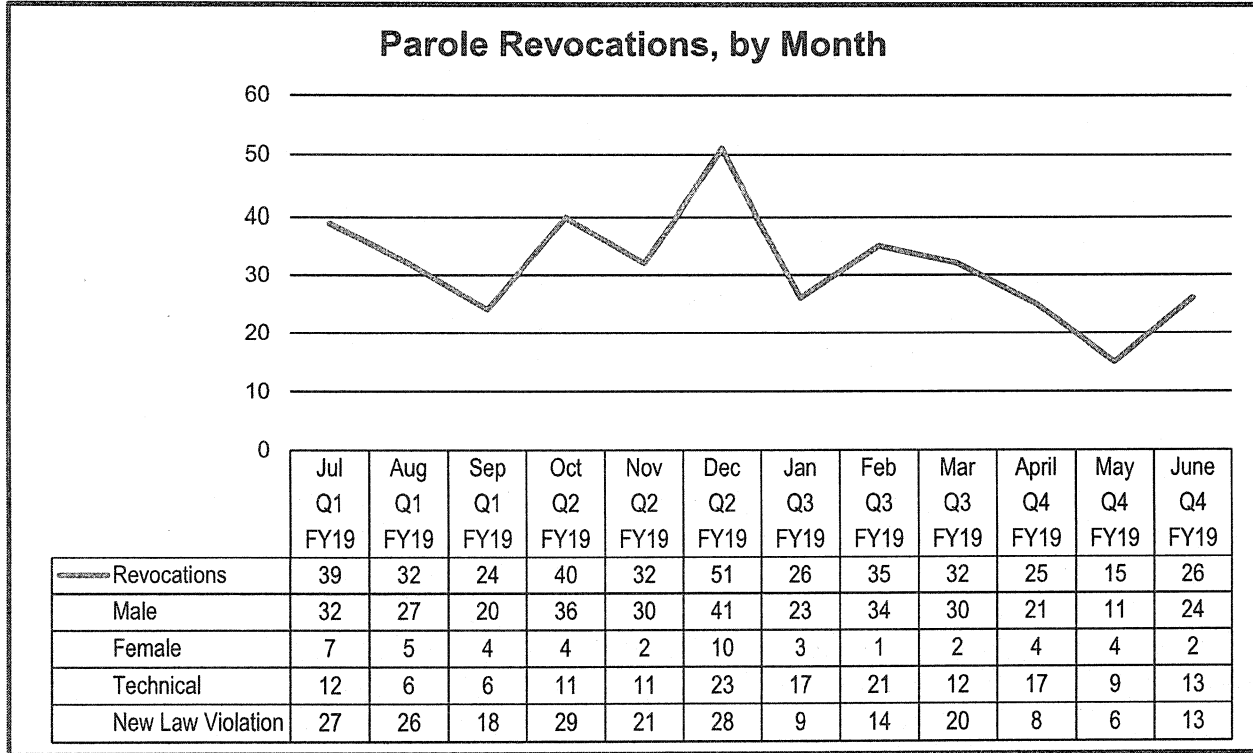

*includes life sentences

"Parole Eligibility Date" (PED) is the date at which it is possible to release a person into the community under parole supervision. "Estimated Parole Term" refers to the length of time people who are housed past their PED could be expected to spend in the community under supervision if released immediately.

Reentry and Discharge (cont.)

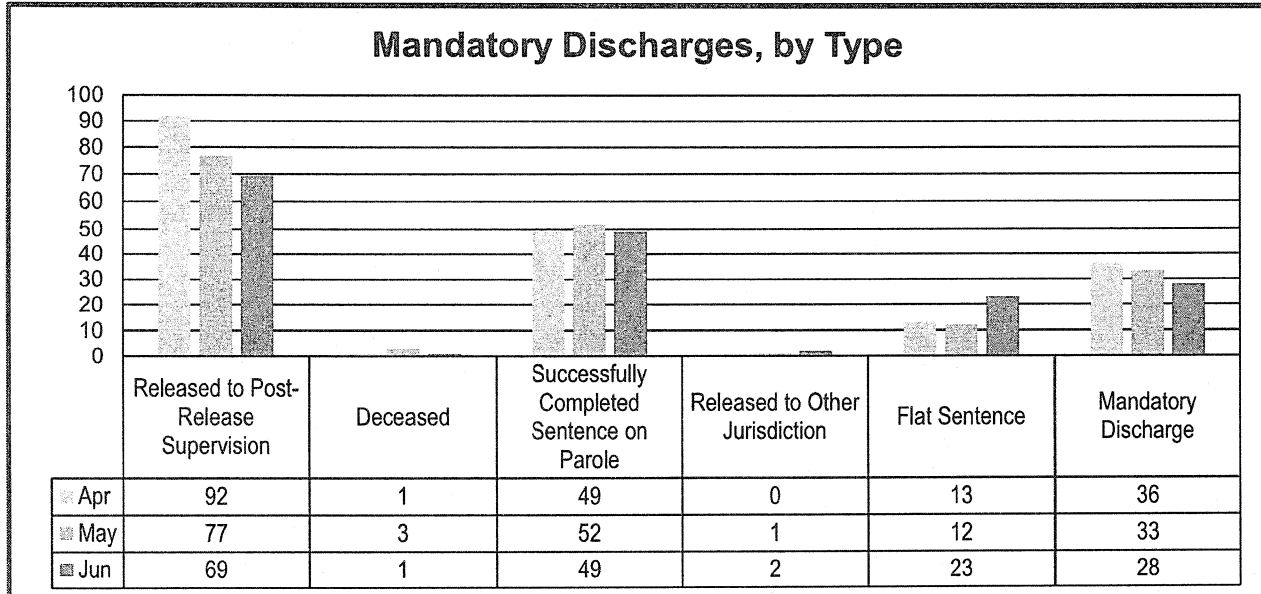

"Post-Release Supervision" occurs after a person discharges from NDCS custody and is a term of community supervision under the Office of Probation Administration. "Flat Sentence" refers to people with the same minimum and maximum sentence lengths, which does not allow for a period of parole during their term of incarceration. "Mandatory Discharge" indicates people who completed their sentence in an NDCS facility and discharged directly into the community.

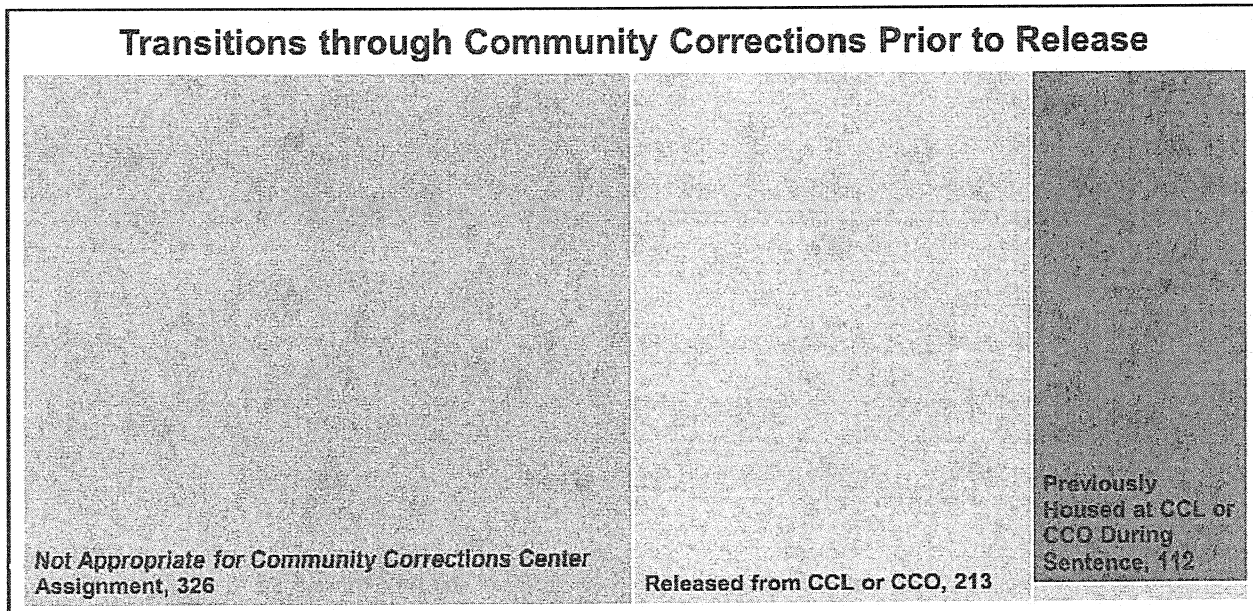

The graphic above considers all individuals who paroled or discharged during the quarter and identifies whether they were able to transition through Community Corrections Center - Omaha or Community Corrections Center - Lincoln prior to their release.

Programming Information - Outstanding Recommendations

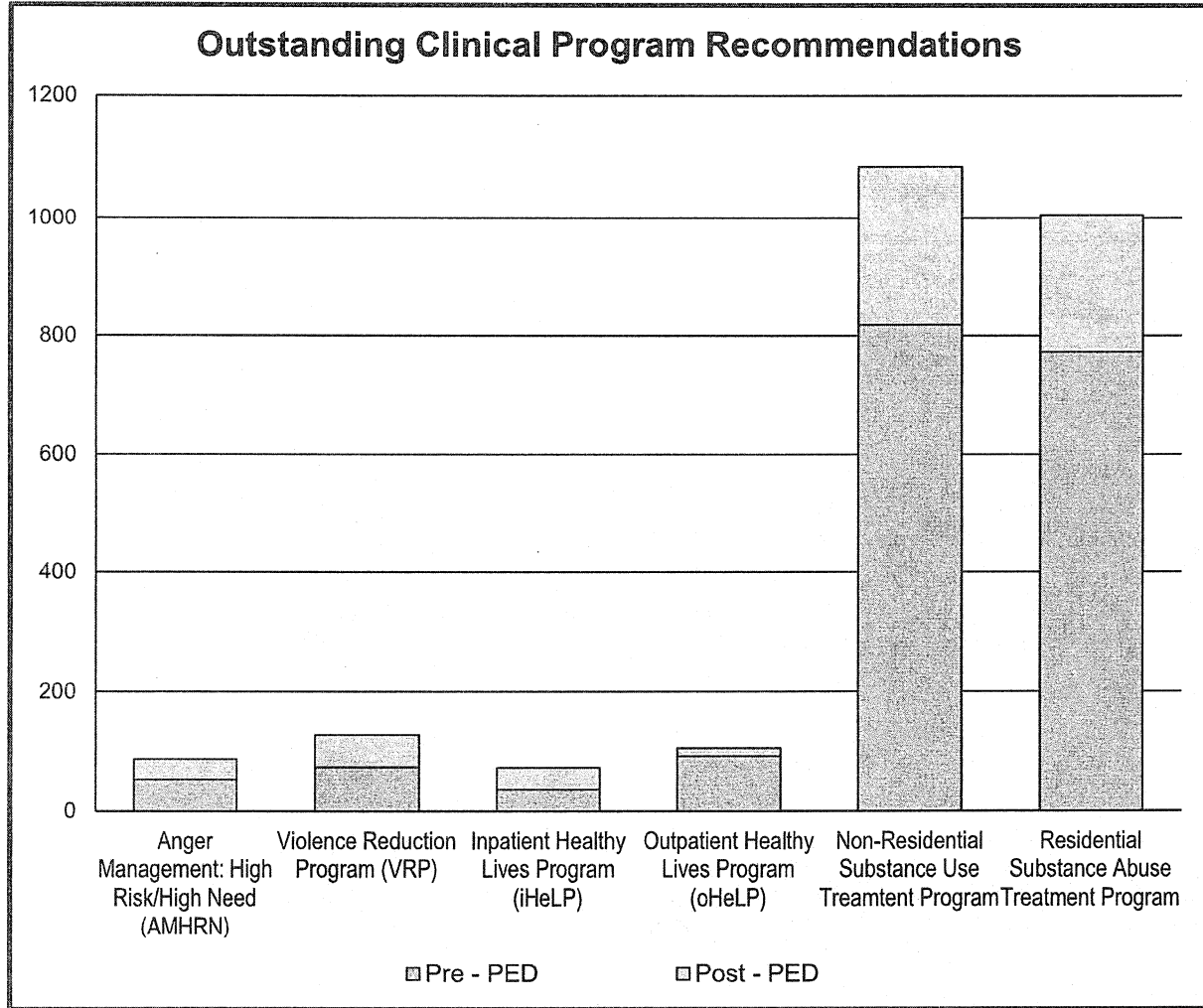

People Past PED with Outstanding Clinical Program Recommendations Time to Tentative Release Date

Program	≤ 6 Months	6 Months to 1 Year	1 to 3 Years	3 to 5 Years	5 to 10 Years	10 or More Years*
AMHRN	4	4	9	9	7	1
VRP	12	0	12	8	11	11
iHeLP	5	5	6	7	5	8
oHeLP	4	1	4	2	2	1
Non-Res.	68	40	62	45	27	22
Res.	50	32	80	30	30	11

*includes individuals serving life sentences

Programming Information - Current Enrollments

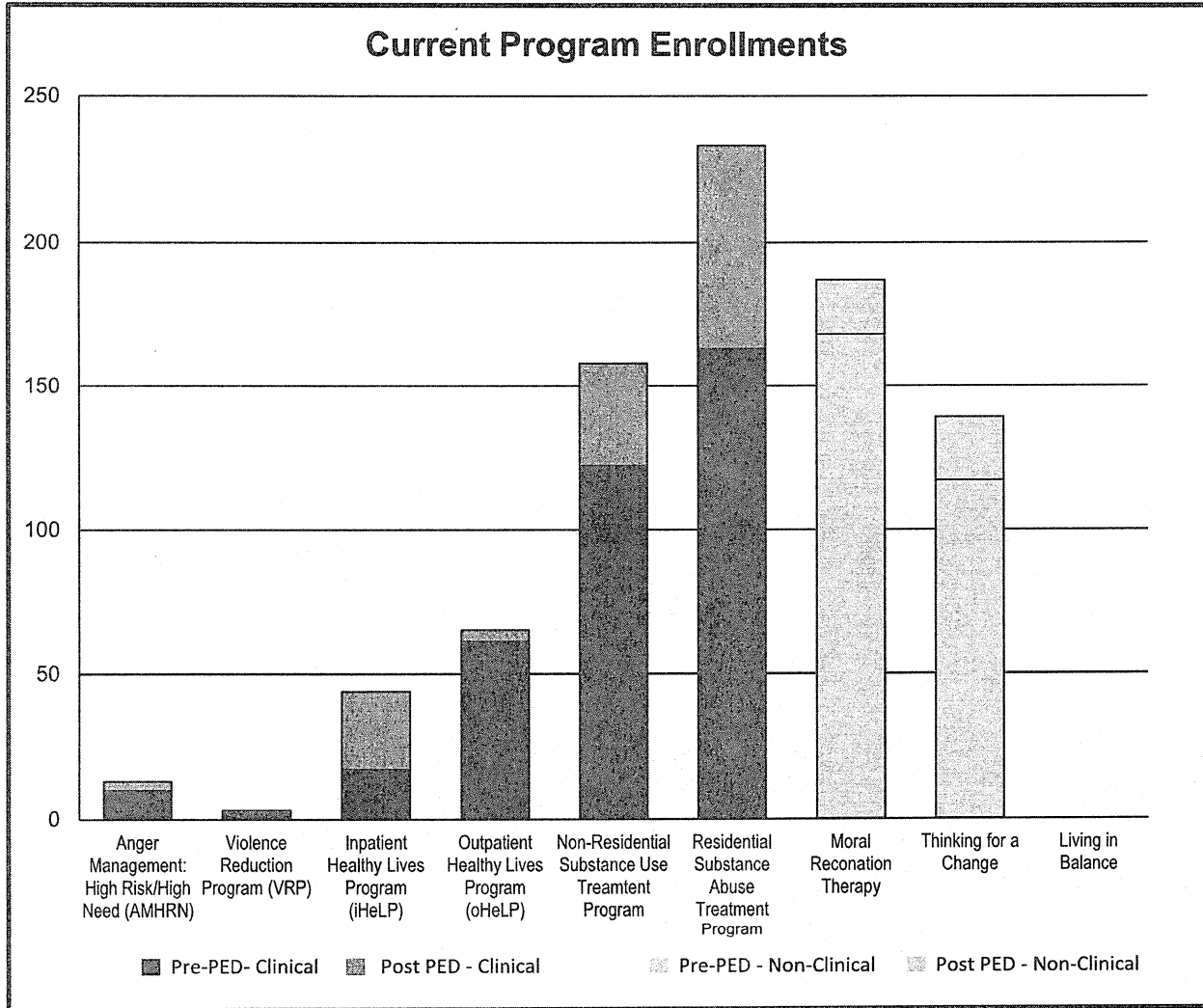

People Past PED Currently Enrolled in Clinical Programming Time to Tentative Release Date

Program	≤ 6 Months	6 Months to 1 Year	1 to 3 Years	3 to 5 Years	5 to 10 Years	10 or More Years*
AMHRN	0	0	2	0	1	0
VRP	0	0	0	0	0	1
iHeLP	1	4	4	7	9	2
oHeLP	1	0	0	1	2	0
Non-Res.	3	9	11	9	3	1
Res.	9	19	25	6	9	2

*includes individuals serving life sentences

Programming Information - Program Completions

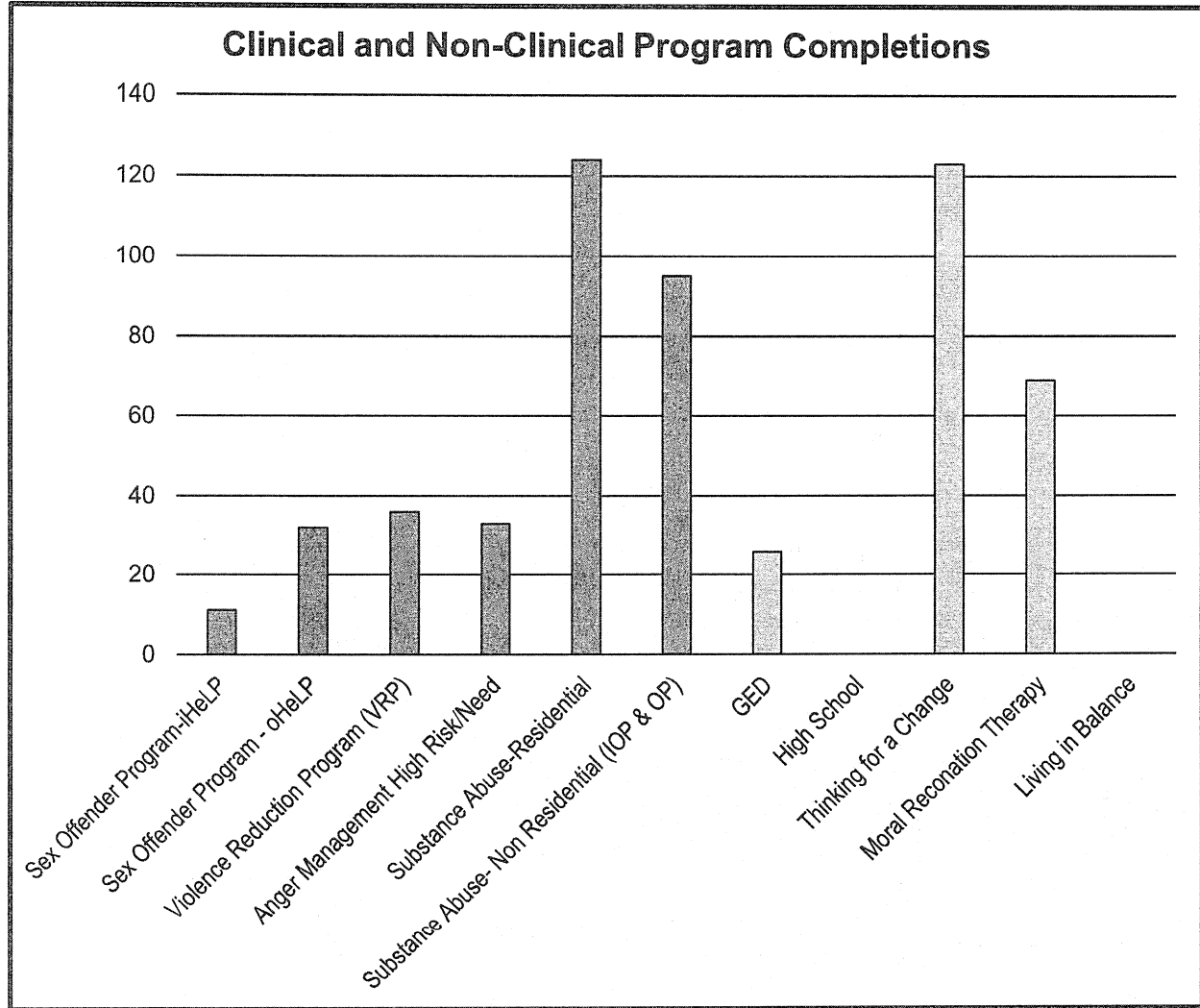

Staffing

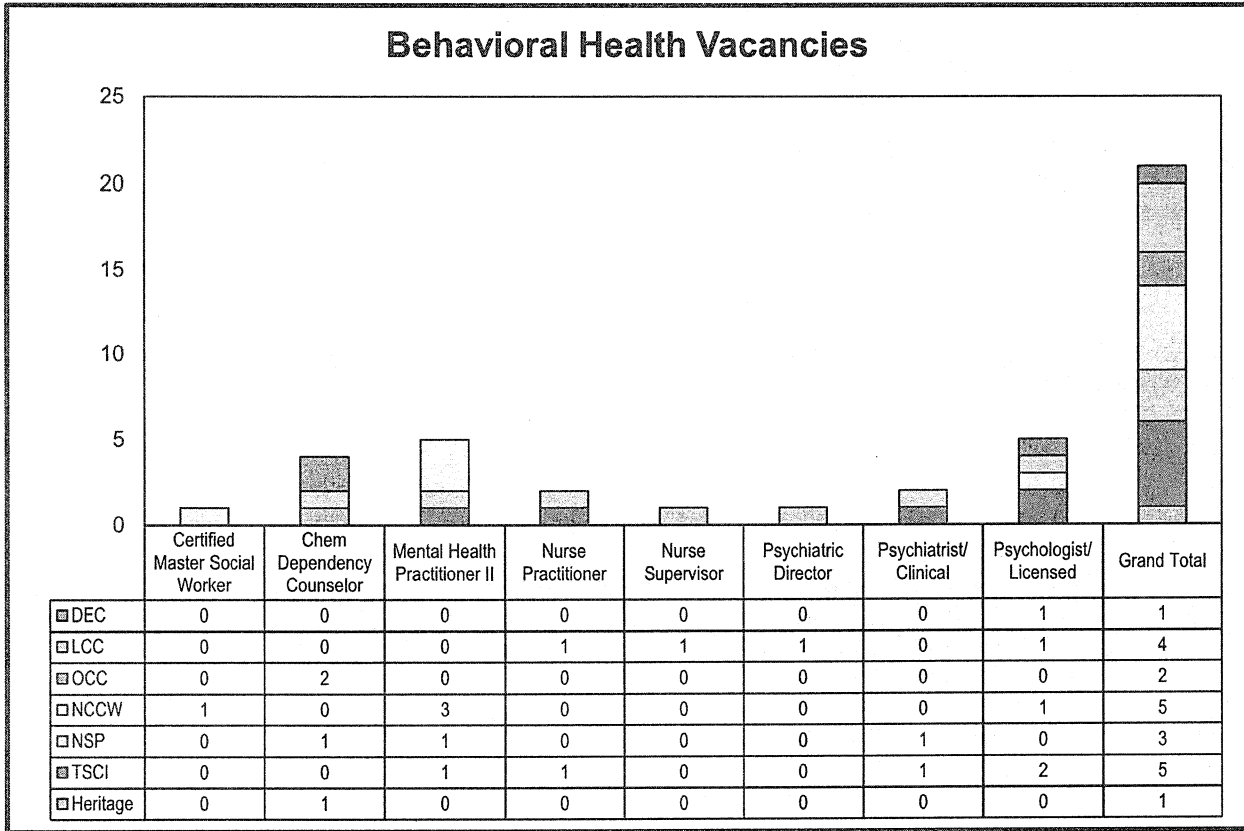

Calendar Year-to-Date Turnover (April-June 2019)

	T/O YTD	Auth FTE	T/O Rate
Total Turnover Rate for Protective Services:	202.00	1,359.00	14.86%
Total Turnover Rate for Nurses:	3.00	71.00	4.23%
Total Turnover Rate for Education:	1.00	28.50	3.51%
Total Turnover Rate for Other:	68.00	1,049.00	6.48%
Total Projected Annual Turnover Rate for Protective Services:			29.73%
Total Projected Annual Turnover Rate for RN's & LPN's:			8.45%
Total Projected Annual Turnover Rate for Education:			7.02%
Total Projected Annual Turnover Rate Other:			12.96%
Total Agency Turnover Rate:	274.00	2,507.50	10.93%
Total Projected Agency Turnover Rate:			21.85%

DOUG KOEBERNICK
Inspector General

N

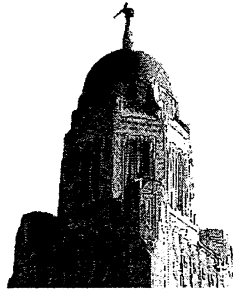

STATE OF NEBRASKA
OFFICE OF INSPECTOR GENERAL OF CORRECTIONS
State Capitol, P.O. Box 94604
Lincoln, Nebraska 68509-4604

November 11, 2018

The Honorable Mike Foley
Lt. Governor of Nebraska
State Capitol
Lincoln, NE 68509

Senator Anna Wishart
District 27
State Capitol
Lincoln, NE 68509

Dear Lt. Governor Foley and Senator Wishart:

In my work as Inspector General of Corrections, I receive many thoughtful suggestions on ways the State of Nebraska can improve the state correctional system. Earlier today, I received a suggestion that would seek to improve the lives of those who have been incarcerated. Since you both have shown such a strong interest in the rehabilitation of those in our correctional facilities and genuinely care about those individuals I thought I would share this recommendation with you.

The recommendation was to establish a state policy that would encourage state agencies to consider hiring previously incarcerated individuals in order to give them a second chance. By doing this, the State of Nebraska would be the example for businesses across the state. I thought this was an interesting idea and immediately began to research it.

I found a couple of examples that I wanted to share with you. The first was from North Carolina where Governor Cooper established a state reentry council (see attachments). He established the group in an effort to assist people in successfully returning to their home communities. I think this effort could have some value and is somewhat similar to legislation introduced last year.

The second example is from New York where Governor Cuomo launched the Work for Success Pledge and Program (see attachments). The pledge is an “online pledge in which businesses commit to consider hiring qualified individuals with criminal convictions.” The Work For Success Program matches qualified individuals with criminal records with businesses seeking employees.

While these initiatives could be accomplished through legislative action I believe that they would also be possible through executive action. I think that such initiatives, especially the one in New York, could have many positive impacts, including the providing of second chances to our fellow Nebraskans and the assisting with our workforce shortage issues. I think that starting with something along the lines of the Work for Success Pledge would be the one that would provide an immediate impact and awareness.

Thank you for your efforts to assist our Nebraskans who have been previously (or currently are) incarcerated. I appreciate your taking the time to review these documents and am available if you have any questions or need anything at all.

I hope you both have a wonderful Thanksgiving.

Sincerely,

Doug Koebernick

attachments



OBJECTIVE ANALYSIS.
EFFECTIVE SOLUTIONS.

RAND > Published Research > Research Reports >

Evaluation of North Carolina's Pathways from Prison to Postsecondary Education Program

by Lois M. Davis, Michelle C. Tolbert

Related Topics: North Carolina, Postsecondary Education, Prisoner Reentry, Students

[Citation](#)

[Embed](#)

[View related products](#)



Evaluation of North Carolina's Pathways from Prison to Postsecondary Education Program

View the full report.



[Read Online](#)

Before 2013, incarcerated individuals in North Carolina could enroll in college correspondence courses, but there was no coordinated effort to provide a path toward a postsecondary degree or credential. Furthermore, there was no coordination around reentry. The Vera Institute of Justice's Pathways from Prison to Postsecondary Education Project (Pathways) was a multistate demonstration project in three states — Michigan, New Jersey, and North Carolina — intended to create a continuum of higher education and reentry support services that begin two years prior to an individual's release from prison and continue in the community for two years postrelease, with the goal of educational progression and degree attainment.

RAND and RTI International researchers conducted an independent evaluation of the North Carolina Pathways Program, examining the implementation of the in-prison and community components of the program, the experiences of Pathways students and staff, factors that facilitated or hindered their participation in the program, and lessons learned. The findings and recommendations will be of interest to

Research Questions

- 1 How was the in-prison component of North Carolina's Pathways Program designed and implemented?
- 2 What were the eligibility requirements for Pathways participants? How were they selected?
- 3 What funding and resources were available for Pathways participants?
- 4 What community colleges and other stakeholders were engaged in North Carolina's Pathways Program?
- 5 What were the experiences of Pathways students as

other states, corrections officials, and educators interested in implementing postsecondary education programs for incarcerated adults.

Notably, North Carolina Department of Public Safety (NCDPS) continues to fund components of Pathways after the demonstration project ended. Pathways affected how NCDPS approaches both higher education in prison and reentry planning. It has led to more coordination among prisons and probation and parole officers and community resources. Because of Pathways, education has become the fourth pillar of the department's reentry focus (along with housing, employment, and transportation).

they transitioned back into the community? What reentry supports were critical? What factors facilitated or hindered continuation of students' educational programs?

6 What adjustments were made and what lessons were learned from the North Carolina model?

Key Findings

It takes time to set up these programs

- Implementing a prison-based and community-based college program with multiple partners for a population with diverse education and reentry needs is challenging. Staff and students reported feeling that a longer commitment (e.g., five years) was needed.

The program needs to allow students to change educational paths upon release

- Postsecondary programs in North Carolina state prisons were limited to a terminal Associate of Applied Sciences degree. The programs offered in prison were for only three majors, which did not always align with students' career interests.

Funding was inconsistent across release communities

- Although each release community received the same budget, the funding was spent differently depending on the size and needs of the student population and available community resources. Variation in spending caused trust and communication problems and created uncertainty among the reentry staff about available resources.

Reentry supports were critical for students

- Housing, employment, and transportation were among the top referrals to services provided to Pathways students, followed by family and substance abuse treatment services.

Having a Pathways navigator and trusted persons of authority was important

- Having a navigator who could help link students to reentry services and assist them in applying for college and financial aid was critical.
- Having Department of Corrections senior leadership support was key to problem-solving, maintaining support, and understanding the concerns of staff.

Staff training and support is needed

- Those involved in Pathways needed clear expectations and defined responsibilities. For many college instructors, teaching in a correctional environment was a new experience.

Recommendations

- Structure the in-prison component of the college program to allow enough time for students to build general credits and earn certifications prior to release.
 - Consider eliminating the state restriction on the types of postsecondary degree programs that can be offered in prison.
 - Structure the program to allow students to initially attend college part-time in the community upon their release from prison. This would allow them to get acclimated and go through the reentry adjustment process and would relieve the stress of trying to go to college full-time while working full-time.
 - Include enough release communities in the program so that students can live near their families and other supports.
 - Invest in reentry infrastructure to ensure that robust reentry supports are available to students.
 - Ensure that community colleges and other education providers are part of the reentry planning and other processes to facilitate students' enrollment and reenrollment postrelease.
 - Ensure that a navigator and other trusted people of authority are in place. The Pathways navigator role was an essential source of support for many students and should be a full-time position. It is important that parole officers understand these programs and support individuals' participation in them.
 - Have a dedicated, full-time program administrator for at least the first few years of program implementation. This individual would need to build partnerships to support the in-prison and community components of the program and be effective in addressing policy barriers.
-

- Ensure that long-term funding options are in place to sustain a college program once initial funding has ended.

Table of Contents

Chapter One

Introduction

Chapter Two

The North Carolina Pathways Program's In-Prison Component

Chapter Three

The North Carolina Pathways Program's Community and Reentry Component

Chapter Four

Conclusions and Recommendations

Appendix A

Overview of the Pathways Demonstration Project

Appendix B

Consent Protocols and Focus Group Discussion Guide for Evaluation of the In-Prison Component of the Pathways Program

Appendix C

Consent Protocols and Focus Group Discussion Guide for Evaluation of the Community Component of the North Carolina Pathways Program

Research conducted by

RAND
SOCIAL AND
ECONOMIC
WELL-BEING

The research described in this report was prepared for the Laughing Gull Foundation and the Vera Institute of Justice and conducted by the Justice Policy Program within RAND Social and Economic Well-Being.

This report is part of the RAND Corporation research report series. RAND reports present research findings and objective analysis that address the challenges facing the public and private sectors. All RAND reports undergo rigorous peer review to ensure high standards for research quality and objectivity.

Permission is given to duplicate this electronic document for personal use only, as long as it is unaltered and complete. Copies may not be duplicated for commercial purposes. Unauthorized posting of RAND PDFs to a non-RAND Web site is prohibited. RAND PDFs are protected under copyright law. For information on reprint and linking permissions, please visit the RAND Permissions page.

JULY 18, 2017 Albany, NY

Governor Cuomo Launches Work for Success Pledge to Encourage Businesses to Hire Qualified Individuals with Criminal Convictions

New York is First State in the Nation with Employer Pledge

More Than 80 Companies Have Taken the Pledge, Including the Target Corporation, Staples, Fresh Direct, and VICE Media - Complete List [Here](#)

Governor Andrew M. Cuomo today announced the official launch of the Work for Success Pledge, an online pledge in which businesses commit to consider hiring qualified individuals with criminal convictions. New York is the first state in the nation to develop such a pledge. More than 80 companies who do business in New York, including Fresh Direct, the Target Corporation, Staples, and VICE Media, have already signed on to the Pledge. Other employers are encouraged to sign on at this [link](#) .

"Providing job training and opportunities to New Yorkers with criminal histories is proven to help break the vicious cycle of recidivism and increase public safety," **Governor Cuomo said.** "The Work for Success Pledge will help provide a chance for these individuals to reenter society and build stronger communities. I thank these businesses for signing up for this critically important program and I urge others to join them."

Lieutenant Governor Hochul said, "When we write off segments of our population because of a single set of circumstances or mistakes made in their past, we deny society of their contributions, and they are denied a chance at a better life.

Governor Cuomo's Work for Success Pledge helps bring formally incarcerated individuals into the mainstream, economically and socially, while helping connect employers to a qualified workforce. Let's remember Jesse Hawley, the man who crafted the original blueprint of the Erie Canal, had a criminal record - and without him, one of the greatest public works of all time may not have been created."

The Work for Success Employer Pledge was launched at an event held today at



ReConnect, Inc

O

Program Highlights

ReConnect, Inc. has witnessed many successes in the lives of the men and women who participate in our pre and post release programs and services. Among the highlights have included a demonstrated commitment from most of the incarcerated men who have taken our classes Success Prep, Final Number or Pass it On to change the perspective of how they have chosen to view their incarceration and serve out the remainder of their sentence which is one of the goals of the classes we teach.

Class participants are writing to us more frequently for self- development books, career guidance and other skills development books as part of our effort to get participants to use their prison sentence to grow their capacity to become better not bitter. ReConnect, Inc. stresses self- education as a means of developing new skills which not only prepares them for reentry success but helps them serve out their sentence more productively and change the culture of prison.

A class we started at Tecumseh in 2017 called Pass it On targets individuals with very long sentences. The purpose of the class is to teach not only life skills but critical thinking, problem solving, communication, and facilitation with the end goal of preparing men serving 15 years to life with skills that will improve their behavior and prepare them to “ pass it on” to others who are incarcerated. We believe the class will have an impact in helping change the prison culture. We know its working by the letters we receive from men who have taken the class and their attitude toward serving out their sentence and helping others not to return.

Formerly incarcerated men and women are visiting our program more frequently to receive services on a consistent basis and we see the results in their reentry success as measured by employment and not committing new offenses. We have two clients who started with us three years ago who are now in the process of the beginning stages of homeownership. We have seen an improvement in both attitude and behavior from among the clients we serve in the office. Individuals are now coming to us immediately upon their discharge or probation so as not to become distracted by other factors which could interfere with their success. We credit this with reaching them sooner while they are incarcerated and establishing a relationship of trust where we are among their first stops when they release.

Two of our greatest highlights are developing two new programs Success Prep Bloom which is a life skills and reentry planning class taught to the women at CCCL and Family Matters, a family reunification program to help families overcome barrier and hardships they may face in helping their love one prepare for reentry and transition back to their home and community. Among the many services offered is mediating family conflict and communication problems which often arise when a family member returns home. Family Matters in being piloted at CCCO and we have 6 families participating since we launched the program in July.

We have been pleased with the opportunity the VLS funding have afforded us to do in serving our clients and we look forward to even greater successes.

Bristol Station Residential Reentry Center, owned by Western Alternative Corrections, Inc., is located in Hastings, Nebraska. The 50-bed facility, which is staffed 24-hours a day, 7 days a week, serves male and female residents in a dormitory-like environment. Bristol Station is based on a reentry model which utilizes evidence-based practices to deliver offender specific programming. Reentry services are guided by the risk, need and responsivity principles which dictate the degree of individualized services and programming. Programming components and services at Bristol Station include, but are not limited to, validated risk/needs assessments, case management, individualized program planning, vocational assessments, employment readiness and cognitive-behavioral programming such as Moral Reconciliation Therapy (MRT), transition skills, and relapse prevention. The overall goal remains that each individual will successfully transition back into their community. In order to achieve this goal each individual will develop a dynamic transition plan to foster employability skills, obtain and maintain gainful employment, and successfully complete all facets of programming aimed toward lowering recidivism risk.

Western Alternative Corrections, Inc. has been fortunate to receive Vocational and Life Skills (VLS) grant funds since the first grant funds were awarded in 2014. Currently the VLS Grant funds 25 of the 50 beds at Bristol Station. Since the start of the recent grant cycle in July 2018, Bristol Station has served over 90 participants with an average length of stay between 5-6 months. Bristol Station participants receive a risk/needs assessment upon admission and at the time of discharge. The data gathered from these assessments indicates that the risk to reoffend is decreased with the successful completion of the program. This is achieved by residing in a highly structured, sober living environment and active participation in programs which target the individual needs and risk factors for each participant.

Bristol Station participants are very active in the Hastings community and receive a tremendous amount of support from the community. Participants regularly volunteer within the community. Bristol Station participants volunteer with multiple agencies such as the Hastings Kiwanis Club at the annual pancake day, Hastings Downtown Association with Kool-Aid Days, Junk Street and Celebration of Lights, Hastings Chamber of Commerce at National Night Out, Hastings YMCA, Project Homeless Connect and at SASA Crisis Center. Most recently Bristol Station residents volunteered at the annual Hastings National Night Out in August. Residents helped prepare and serve hamburgers and hotdogs to members of the Hastings community. One volunteer from Bristol Station stated "this was the most fun I've had since I've been out of prison." Their support of National Night Out and willingness to volunteer their time in the community was recognized by officers of the Hastings Police Department, as well as by the Hastings Chamber of Commerce. We continue to be very proud of our involvement within the Hastings community and are grateful for their continued support of our program at Bristol Station.

Bristol Station participants are given an anonymous survey during their participation in the program. Here are a few of their responses to a few questions:

Q: Has Bristol Station been helpful for you?

A: "Bristol Station has been very helpful for me. Bristol has helped me get my social security, birth certificate and identification. Since I've been here the staff has showed me a lot of respect and has given me the care that I needed."

A: "Yes, they have challenged me to succeed in life and also helped me push myself to become responsible."

A: "Definitely yes. B.S. has provided me with a drug/ alcohol free environment. It also is helping me save money for my own place and furniture. I have already in less than 90 days gotten a truck, a good job and I'm well on my way to saving up money."

A: "Sometimes Bristol Station can be a little tough. But at the end of the day, if you're trying to better your life, they help you open doors that otherwise weren't so easily opened. Since arriving at Bristol Station, I have secured a future in Seattle, a valid driver's license, a commercial driver's license, clothes, shoes and they worked with me on my finances."

A: "Yes, very. To have a place where I absolutely have to be clean and sober gives me some comfort and has allowed me to make some attainable goals."

A: "Yes it has. It's making sure I stay on track. Keeps me doing little responsibilities that I'll always have to do in life. This place has helped me start building my life back and with the programs I've been in, it helps with other little things I will be faced with in life."

Q: Why did you choose to come to Bristol Station?

A: "It was an opportunity to get on my feet from what I lost and be able to transition back into society in a clean and sober environment, and help me establish a right mindset before I go out on my own."

A: "I needed the opportunity to get on my feet. The structure, although can be hard, is very needed. A safe place to work on my goals."

A: "For the structured environment, learning to live and the classes offered here."

A: "I want to better my outcome of success, knowing that I have no distractions. I can really focus and maintain and manage my stability. My mental capability to be sober."

A: "I had heard from other people that it had good programming. And it is close to my family and where I'm from."

Q: Why did you choose to come to Bristol Station?

A: "Change. Wanted to get away from my triggers and get a fresh start."

A: "I heard it was a good place to help you get on your feet and I didn't want to go back to where I came from right away after prison."

A: "For a support network, programs and to be proactive in my recovery and rehabilitation."

A: "It was an opportunity for a fresh start."

Q: Do you feel the support/help you have received at Bristol Station has been helpful?

A: "I learned to truly respect all the staff and what they were doing to help me. Tara is a very compassionate case manager and supported me with praise and honest concern for my wellbeing."

A: "Yes, it has been very helpful and Gene keeps my mind positive and tells me to keep going."

A. "Tara, because she helps me set realistic goals."

A. "Everything has been helpful for me after being locked up for 10 years. All the staff has been helpful with everything in pointing me in the right direction."

A. "All staff members have been helpful to some point. When I had a question or concern, they tried every way possible to answer or help in any situation."

A. "Yes, it's nice to have someone treat me with respect. Tara has been super supportive."

A. "Obviously Tara has been instrumental in my recovery. That has been clear, I think to everyone. Angela's positivity makes for a healthy environment. Ed and Ed are your greatest assets as to day to day staff. They're a breath of fresh air."

Q: If you had to explain Bristol Station to someone who doesn't know anything about Bristol Station, what would you say?

A. "That it's a great place to be if you're willing to follow their rules and are serious about changing. Let them know it has helped me tremendously and don't know where I'd be today if it wasn't for Bristol Station accepting me."

A. "A great structure. A great way to get your life together. They have rules that will play a important role in life later on. The staff is nice and respectful. They help you get a job."

A. "It's a facility that has programs that help you get incorporated back into the community. They help you get the resources you need. If you need help with anything, they help you."

A. "Bristol is basically what you want to make of it. If you don't want to be here or have a bad attitude towards the program you will not like it here or you won't be here long. Everyone is here to help and want to see you succeed."

A. "B.S. is an excellent opportunity. They have classes that help you focus on what's important. The staff is there to help you, not get you in trouble. Most excellent for transition."

A. "It's a halfway house for those who are indigent and looking to start from absolutely nothing. They know that daunting feeling of having absolutely nothing when you get out of prison. No matter how bad you were or what your charge was...without judgement they will help you."

Metropolitan Community College (MCC) formalized the 180 Re-entry Assistance Program (180 RAP) in February 2015 but we have been serving the re-entry population for years. 180 RAP serves the currently incarcerated and re-entry populations. Anyone who has served in a county, state or federal facility are eligible to participate in MCC's 180 RAP.

We serve individuals incarcerated at eight Nebraska prisons: Omaha Correctional Center (OCC), Community Correctional Center – Omaha (CCC-O), Tecumseh State Correctional Institution (TSCI), Lincoln Correctional Center (LCC), Nebraska Correctional Center for Women (NCCW), Nebraska Correctional Youth Facility (NCYF), Community Correctional Center – Lincoln and Nebraska State Penitentiary (NSP). We also partner with Nebraska Parole and Probation. While the work MCC 180 RAP does is expansive, we do not work in a silo; we partner with other community organizations, providers and employers to ensure the population has increased access to suitable employment, housing, healthcare, mental health and recovery support and transportation.

While MCC's focus is education and training, our goal is to connect the population to gainful, meaningful employment so they become contributing members of society and do not recidivate.

In order to help the population achieve their education, employment and personal goals, 180 RAP helps the population address other barriers to their successful transition by providing an onsite Job Center, Computer Center and Re-entry Pantry providing nonperishable food, hygiene items, gently used clothing and footwear. A majority of MCC's 180 RAP staff has a criminal history so we provide peer support through all levels of engagement.

MCC registered 185 students in college credit classes taking place in four Nebraska prisons during fall quarter at Lincoln Correctional Center, Nebraska Correctional Center for Women, Omaha Correctional Center and Tecumseh State Correctional Institution. Topics include Business Law II, Construction Safety, College and Career Strategies, Problem Solving and Programming, Intro to Process and Power Operations, Intro to Microcomputer Fundamentals and others. There are 77 incarcerated students registered in noncredit classes: CDL Preparation, Financial Empowerment, Living Above Your Circumstances and Long Term Relief.

Recent data includes:

- From February 2015 through July 2019, MCC served 4,437 people through 180 RAP.
- In August 2019, 180 RAP served 115 people in the Job Center and since January, the Job Center has supported 600 people. Our traffic in the Job Center has doubled since June.
- During the past eight months, 1,063 individuals have utilized the Re-entry Pantry.
- The cumulative grade point average for incarcerated students in summer quarter (19/SS) was 3.86 with a 100% completion rate.

The Second Chance Education Program is designed to offer an Associate of Arts degree to women at the Nebraska Correctional Center for Women. The program began in January, 2016, with a cohort of 12 women. Over a course of 3 1/2 years, faculty from York College went out to NCCW to teach a variety of General Education courses. The first cohort finished in August, 2019, with all 12 women receiving their A.A. degree. The second cohort of 12 women began August 22, 2019. In addition, one of the women from the initial cohort is now out of prison, and attending York College as a full-time student to receive her B.A. degree.

Senators of Nebraska
P. O. Box 94604
Lincoln NE 68509-4604

RECEIVED BY

July 15, 2019

JUL 17 2019

P

OMBUDSMAN'S OFFICE

Dear Legislator Members:

I am a part of the Nebraska State's incarcerated people that are serving a sentence of life imprisonment.

Under the due mitigating factors which have been placed upon the IA Felony defendants, those of us that are sentenced to first degree felony murder that received a sentence of life imprisonment have received Death by Incarceration (DBI). I will explain . . .

Over the last 30 years, our Nebraska Board of Pardons has shut the door on those of us who are sentenced to life imprisonment. Throughout the 1980s, life sentences were being commuted and those men and women received opportunities to be accountable for their own actions and rehabilitation. Many ex-lifers that were serving a life sentence received opportunities to work at a detail center which offered each person a chance to work at the Governor's mansion. They worked for different government agencies, and they were also allowed to attend community colleges to further their education. There were no negative infractions occurring from their participation in those areas/programs.

Those ex-lifers that paved the way for us individuals sentenced to life now, they knew their disposition of how they acted would determine the outcome of our re-entry today. Each ex-lifer that experienced that elite opportunity was always on their best behavior because they didn't want to lose the little freedom and liberties they were granted. And I sincerely believe that same expected behavior will be displayed if the opportunity presents itself to the selected individuals that complete their requested criteria that mandates a 30 year mandatory structure.

Over the past decades, the administrators in the position that could've made a big difference in the regulating of placing individuals sentenced to serve a life sentence into pellucid positions, as the past administrators had done, which they had always known that individual sentences to first degree life balanced out the vicissitude among their peers. This is one of the main reasons lifers were allowed to be at community correctional centers, because they knew first, that individuals serving life sentences were not a threat to that environment or to the perimeters of society. Therefore, people who had experienced serving a first degree life sentence were being utilized in all government agencies.

The blanket decision we received from the government went against everything Nebraska people stand for. That decision did not give any of us a fair chance to represent ourselves under Nebraska guidelines. This is why it is important to have the Jurisdiction Committee to hold pardon hearings when the other power people won't grant them to us. It would be nice to have an "appealing process" in place to take a second look at our qualifications and dispositions, when we are qualified for promotions and/or being considered for parole or pardon decisions or release.

Having the Nebraska Legislature to present new language on behalf of the men and women who are serving a life sentence, will provide material that will require being followed and presented in a fair manner among the prison populace. As it stands now, there's no language that can be researched or utilized in an appropriate fashion.

In addition to this request for individuality, I have presented "A Fair Act Treatment Proposal 2018 and 2019" to the legislature for their viewing and consideration. I would really appreciate if the legislative body would really take that proposal seriously. The men and women serving life sentences will have a fair chance for progression in a fair act way. Accepting this proposal would allow restricted offenders (as myself) an opportunity to wear an electronic monitor and have supervision from a professional agency as well.

I understand that this process will require a constitutional amendment of some sort which might be a long process that would be initiated in and by the legislature. Our current "long process" is—30 years of being stabilized in one level of transition, without any positive sanctions or laws in place to filter us through the prison system as our constituents receive when they complete their large amount of their sentence,

To get the legislature to participate in this process is vital. There are several legislature committees within its core that could make a big difference in the decision making of the Nebraska prison code.

Utilizing the judicial committee to balance out the policies and procedures within the correctional channels and within the pardon and parole administration, this challenge will eliminate the unnecessary unfair treatment from those agencies. This way we all could

benefit from the 8 member board when we make a request to have commutation hearings or have our cases examined, there won't be any discrepancy.

As I said earlier: as it stands now, there are no real guarantee in our being released from prison. Only "BDI" (Death by Incarceration) is our option. DBI already claimed more than 20 first degree lifers in the last 5 to 10 years with no end in sight.

To complete this letter: I am presenting this material to show the needed adjustments our state needs in the area of population control within its correctional agencies. And we all know that those individuals that served a 1st degree sentence do not recidivate once they are released. **98% of ex-lifers do not return to prison.** That is a very good number representing people sentenced to a life sentence.

To leave a thought in your mind: our state gives all 2d degree lifers a 2nd chance to be a good civilian. That's fine with me, but do they understand there's no real difference between 1st and 2nd degree sentences aside one went to trial and one took a plea deal. Over all, both cases have premeditated intent and both deal in malice. So—if 2nd degree can adapt to society transitions, 1st degree people can do the same.

Thank you for reading my letter. I hope this letter will make a difference.

Sincerely,

Crescent Willie Tucker

#34490 NSP

CC: Judiciary Committee by letter

~~All senators via e-mail~~

↙ Doug Koebernick, Inspector General

Lt. Gov. Mike Foley

James Davis, Ombudsman

Mel Beckman, NCJR Editor

Dwayne Tucker

Fair Act Treatment Proposal of March 20, 2019

To: Senators of the Legislature of Nebraska

For: Session 2019

From: 114 People Sentenced to Life In Prison
Who Have Served 20 Years and Up

Date: May 20, 2019

Potential Representation:

Senators requested:

Steve Lathrop, Chair	Dist 12
Tom Brandt	Dist 52
Ernie Chambers	Dist 11
Wendy DeBoer	Dist 10
Adam Morfeld	Dist 46
Patty Pansing Brooks	Dist 28
Julie Slama	Dist 1
Justin Wayne	Dist 13

Sec.4)The Administration of Nebraska Division of Parole Supervision has implemented an Administrative Regulation Number 410.15 since June 1, 2006.

This program addresses Electronic Monitoring for Adult Parole Administration. This program provides an ankle monitoring assistance that can require a lifetime monitoring service which will elevate the lifers that can be in society. This option is accessible to Nebraska Department of Corrections to coincide with the Parole Board advice.

If we, the lifers population, can have the legislation to address lifetime community supervision within this next session, it will provide a future for the men now and for those in the future. This program would be designed for those with more than 25 years served and would identify individuals that have earned an opportunity to progress across levels of supervision.

The monitoring service is to guarantee safety and security of society and the citizens of the state. Each lifer that is subject to participate in this program will be held at a higher standard than others.

Senators, in closing, through the adoption of legislation detailing new criteria for lifers that would allow persons serving sentences of life imprisonment to be able to progress to community custody environments until a pardon is granted.

Expanding electronic monitoring would open space in community corrections and in correctional facilities, which would allow more persons to benefit from these areas of transition and re-entry.

Expanding this program through legislation would develop more opportunities for everyone incarcerated.

Thank you for your time



LB 567

LIFE SENTENCES: FIRST DEGREE MURDER AND KIDNAPPING

Prior to July, 1986:

Crimes committed prior to July 1, 1986 will be considered for programming (including a recommendation to the Board of Pardons for commutation of the Life sentence to a definite term of years) after the offender has served 15 calendar years in which the last five (5) years have been free of disciplinary action.

After July 1, 1986:

Crimes committed after July 1, 1986 will be considered for programming after 30 calendar years have been served in which the last five (5) years have been free of disciplinary action.

APPROVED:	11-83
EFFECTIVE:	11-83
REVISED:	4-22-91
REVISED/REVIEWED:	4-94
REVISED/REVIEWED:	3-27-97

OUR GOAL

We hope to obtain enough signatures to convince the Nebraska Legislature and Governor that people of Nebraska are willing to give these 114 "Forgotten Lifers" a second chance at life in society.

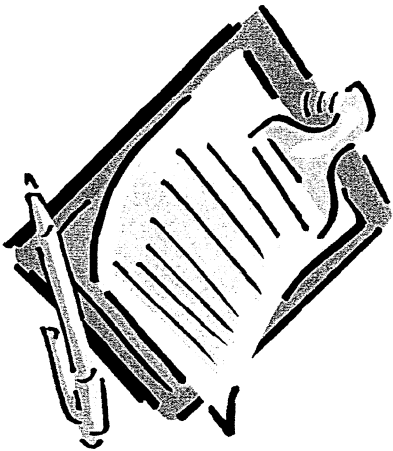

PLEASE HELP

Yes—you too can help to make this goal a reality just by signing a petition form and/or by being a volunteer circulator.

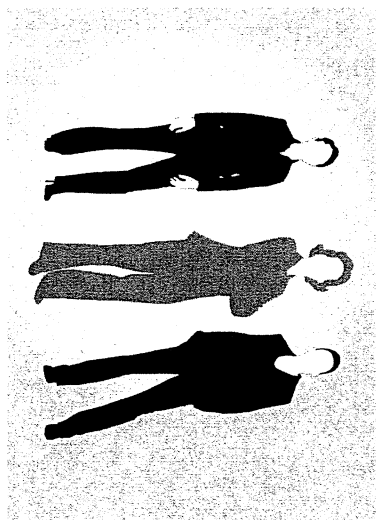

These men and women are the "cream of the crop."

Many of them have become certified **Peer Supporters** mentoring the young and new prisoners.

Most of them have been enrolled in **Defy Programs** offered that teaches them how to be successful in their own businesses and personal relationships.

All of them are involved in **Self-development Clubs** and **Continuing Ed Classes**.

- These dependable, bright and outstanding "Forgotten Lifers" are requesting NE Legislators to consider making changes to the existing criteria for Lifers so that they can have the opportunity to be paroled, provided that they:
- A) Have been well-behaved model prisoners.
 - B) Have passed Nebraska DCS' psychological evaluation tests.
 - C) Will wear ankle monitoring devices.
 - D) Will be approved to attend work release centers
 - E) Will have the opportunity to be employed in the community.

CLASSES OFFERED BY LIFERS

- Restorative Justice (Diane Amdor)
- Strength Finders (Todd Johnson)
- Illegal to Legal (Bob Pelslaw)
- Emotional Awareness (T. Mickles)
- Peer Supporters (MHA—Casey)
- Healing Group (COCLLO)
- Emotional Stance (COCLLO)
- Model to Mentor (COCLLO)

There will be a variety of new programs in the future which, with the help of society, will help put men on a positive path of being trusted to not re-offend when released.

"FORGOTTEN LIFERS"

Why the term forgotten?

Many prisoners go in and out of our prisons, over and over again. But yet the NE Parole Board keeps letting them out..

There are some people with life sentences in prison that do have the possible chance to be paroled if the NE Parole Board so choses.

And then there's what we call the "**FORGOTTEN LIFERS**". They were sentenced with no parole eligibility and the only thing they have to look forward to is someday dying in prison,

The only way they can ever be paroled depends on the mercy of the NE Board of Pardons. The present Governor, a member of that board, has stated that the people of Nebraska do not want to have any Lifers in their communities. We hope to disprove that theory!

"FORGOTTEN LIFERS"

A group of Lifers have submitted a request to some of the senators of the Nebraska Legislature to consider adopting changes to the criteria for Lifers.

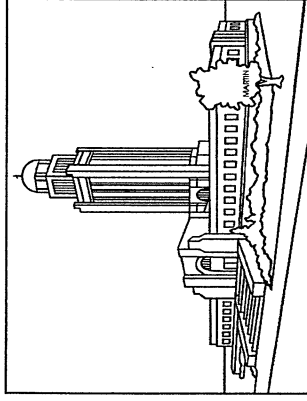

If some or all of their suggestions make it through committee and the full legislature, and aren't vetoed by a governor, then we can convince them and the governor that Ex-Lifers are not a threat to society.

98% of Lifers do not recidivate!

Contact Info:

"Forgotten Lifers"

c/o La Verne Belt

Box 3791

Omaha NE 68103-0791

"FORGOTTEN LIFERS"

Within our Nebraska prison walls, can be found 114 men and women who are well-behaved and model prisoners who have spent 20 to 50 years incarcerated.



Parole's Transition – Progress Continues Three Years and Counting

A lot has happened since Parole's Annual Update was published in August 2018. It recapped the accomplishments since being placed under the Nebraska Board of Parole's authority July 1, 2016. Since that time, much progress has been made and some of the highlights follow:

Online payment of programming fees by clients was implemented September 1, 2018; this new process has gone well and has helped streamline the payment process.

In the fall of 2018, the Director of Parole Supervision met one on one with all staff of the agency to receive feedback—it was invaluable to hear from staff their thoughts and to talk with them about the direction of the agency. Input from staff during these conversations was the catalyst for a number of positive changes that have occurred during the year.

In the area of technology, the use of tablets for officers was implemented and has been instrumental in helping the agency move forward with its electronic files initiative throughout the agency, including electronic field files for officers, which was just recently implemented.

A highlight of the All Staff Meeting held the end of November 2018 was a workshop presented by Retired Chief of Police Harry P. Dolan on techniques for verbal de-escalation. This training was well received by staff.

“Kudos Jars” was implemented the beginning of 2019, a form of tangible incentive which provides an opportunity for officers to recognize clients for an accomplishment or progress with a goal.

In April of 2019, case planning training for staff was presented by the University of Cincinnati Corrections Institute (UCCI). Case planning for clients is in line with the Ohio Risk Assessment System (ORAS) risk assessment and Effective Practices in Community Supervision (EPICS), the case management model that is utilized by Parole.

The Quality Assurance program has continued to move forward and culminated in the creation of a new division within recent months. It has included the implementation of Continuous Quality Improvement (CQI) reports for field staff and supervisors.

Parole was pleased to be able to implement an assistant parole officer position to assist with drug testing and other tasks routinely handled by parole officers at the Omaha Regional Parole Office; a second position was recently implemented for the Lincoln Regional Parole Office. Another area of change has been the piloting of Administrative support staff to assist parole officers in making collateral contacts; the pilot went well in the Omaha Regional Parole Office and plans are to expand this in other parts of the state. In addition, two low-risk supervision officers were established in the Lincoln and Omaha Regional Parole Offices and an Administrative support staff position was established to assist the Western Region.

Parole continues to work with county jails to house clients whose violations are addressed through custodial sanctions. The agency recently put out a Request for Proposals for jail contracts and appreciates the partnerships that have been developed with participating jails to implement custodial sanctions within Parole.

The agency continues with process improvement projects as part of Governor Pete Rickett's initiative to increase efficiencies and improve agency processes. Agency staff have received certification in Lean Six Sigma White Belt and Yellow Belt, and executive staff the Executive Green Belt certification.

In May of this year, the agency was pleased to see a decline in the number of clients appearing before the Nebraska Board of Parole for Review of Parole Hearings for violations of parole; this is attributed to the work that has been done in reforming the agency.

On July 16, 2019, a signing ceremony was held at the Nebraska State Capitol in which Governor Ricketts recognized agency staff for their work in providing community based supervision and services to our clients and proclaiming July 21-27, 2019, as Pretrial, Probation, and Parole Supervision Officers Week. Several events were planned and coordinated by members of the agency's Awards & Recognition Committee to celebrate staff throughout the agency. Their efforts were instrumental in making Parole Week a success and in showing agency staff appreciation for the contributions they make every day to help ensure public safety in our communities.

An All Staff Meeting will be held in September at which time the Director of Parole Supervision will share the agency's accomplishments of the last three years and what Administration sees for the future of the agency. *With change comes endless possibilities.*

Stay tuned for Parole's Annual Update 2019, which will be published in the near future.

From 0 to EBP in Under 4 Years

COUNCIL OF STATE GOVERNMENTS (CSG) &
NEBRASKA BOARD OF PAROLE/DIVISION OF PAROLE SUPERVISION (DPS)



Division of Parole
Supervision



@CSGJC
@DPSNebraska



csgjusticecenter.org
parole.nebraska.gov



dpsscienceandart.wordpress.com

R

WELCOME!

Let's talk about EBP implementation...

Session description: The implementation of evidence-based practices within a supervision agency is challenging under the best of circumstances but add in legislative mandates, organizational restructuring, and culture change and it is downright daunting. This workshop will explore the transformation of the Nebraska parole administration and the use of technology and data to promote and sustain practices. Implementation challenges and strategies for success such as real time customized dashboards, quality assurance tracking, and the use of "The 4:1 Behavior Management System" software from Carey Group Publishing will be discussed...

AGENDA

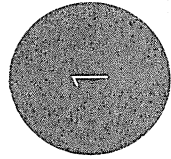

WHO WE ARE

About CSG Justice Center and the Nebraska Board of Parole/Division of Parole Supervision

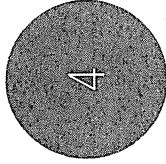

ESSENTIAL TOOLS

The tools we used to get where we are

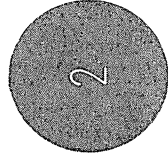

EBP EVOLUTION

What we've done the last few years

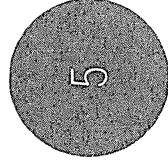

QUESTIONS/DISCUSSION

Let's chat!



HOW WE DID IT

The way we put our EBPs into place

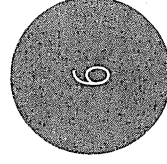

THANK YOU!

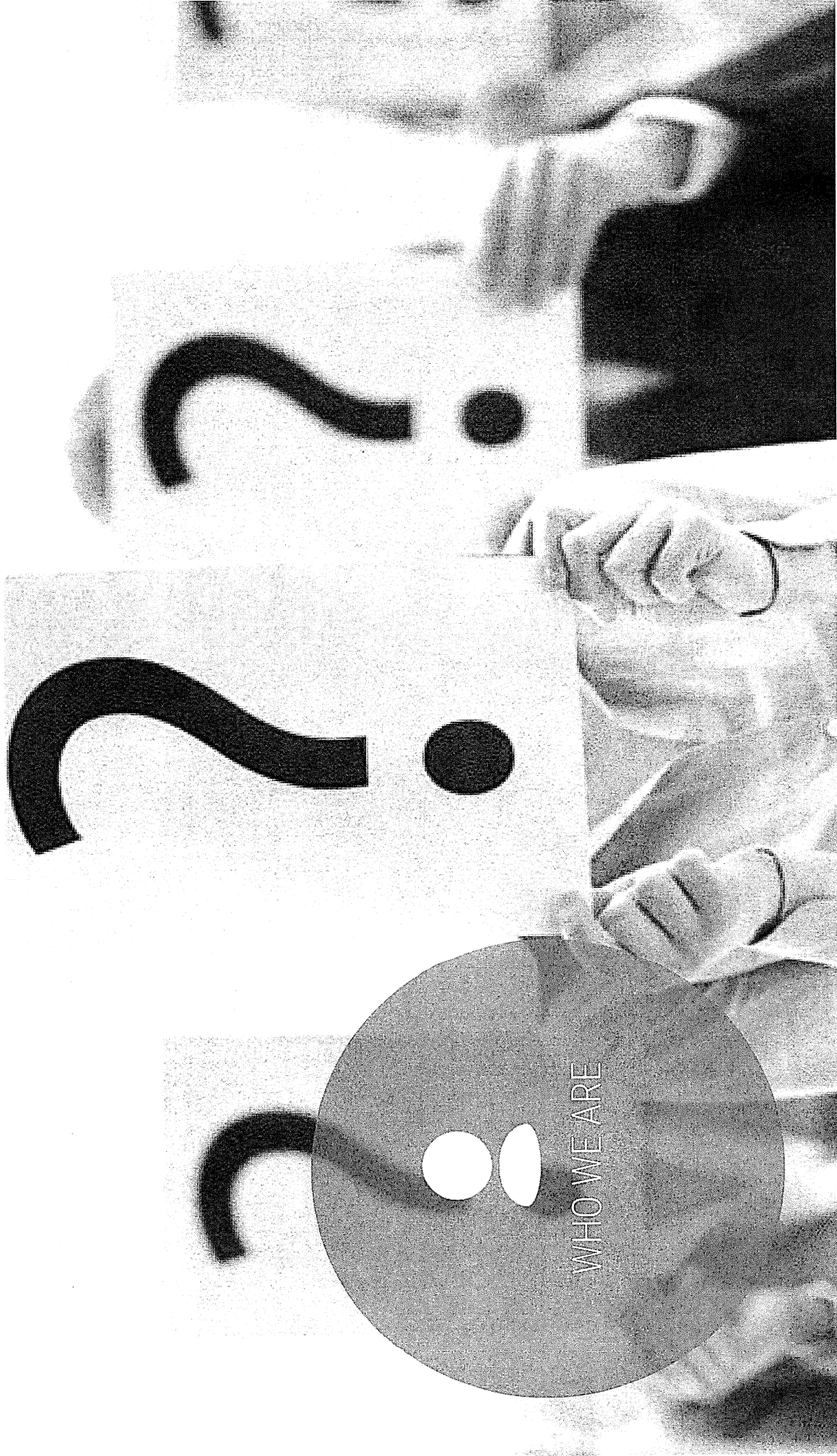

WHO WE ARE

COUNCIL OF STATE GOVERNMENTS

The Council of State Governments (CSG) is a region-based organization that fosters the exchange of ideas to help state officials shape public policy.

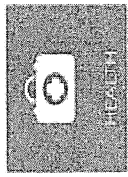
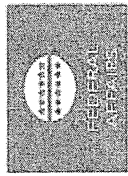
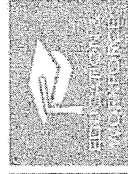
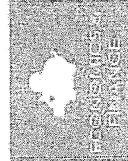

CSG Regional Offices

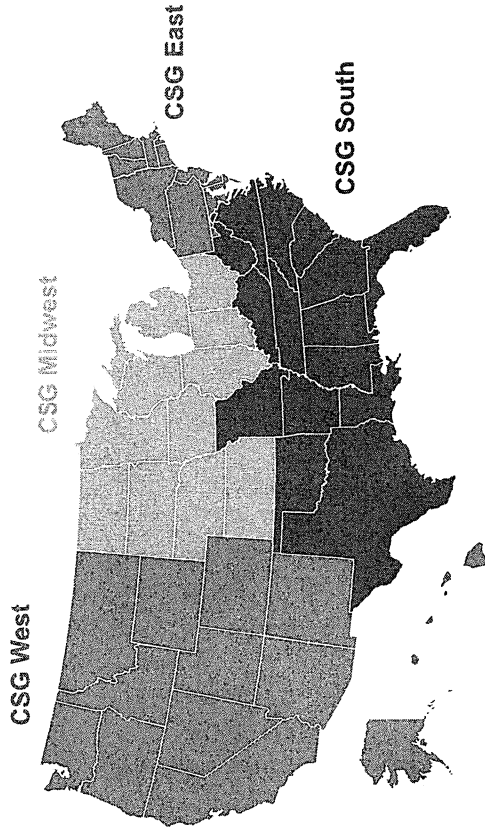

- CSG Products & Services
- Capitol Ideas Blog
- Capitol Ideas Magazine
- CSG eCademy
- Henry Tolls Fellowship Program
- National Center for Interstate Compacts
- Shared State Legislation
- The Book of the States

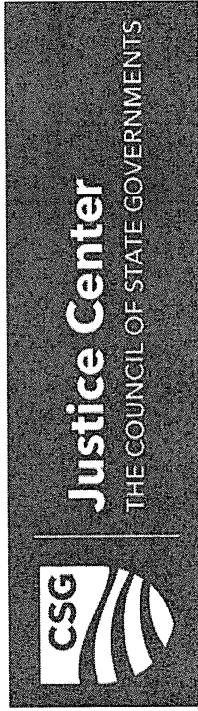

The Council of State Governments (CSG) is a national nonprofit, nonpartisan membership association of state government officials that engage members of all three branches of state government.

The CSG Justice Center is a national nonprofit, nonpartisan organization that combines the power of a membership association, representing state officials in all three branches of government, with policy and research expertise to develop strategies that increase public safety and strengthen communities. For more information about the CSG Justice Center, visit www.csjusticecenter.org.

Corrections



Justice Reinvestment



Mental Health

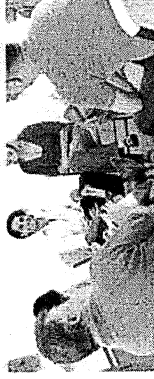

Reentry

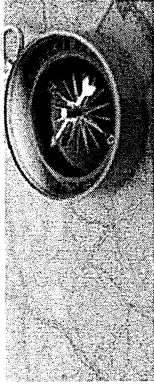

Substance Abuse



Youth



Courts



Law Enforcement

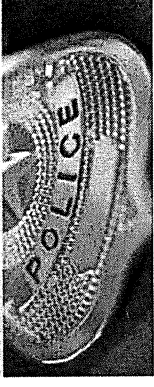

NBOP/DPS



BOARD MEMBERS

Five independent members make up the Board of Parole; led by Chairperson Rosalyn Cotton



EXECUTIVE TEAM

Led by our Director of Supervision and Services Julie Micek, our 4-person executive team oversees administration, field services, research, and IT



FIELD STAFF

Across Nebraska, we have 7 field supervisors and 40 parole officers who engage directly with our clients



ADMINISTRATION

To support our team, we rely on 14 administrative staff members who coordinate all our work statewide

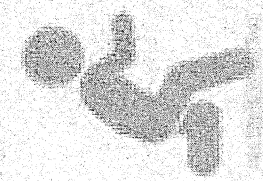
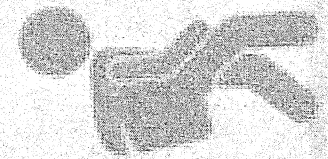
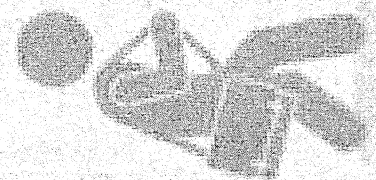
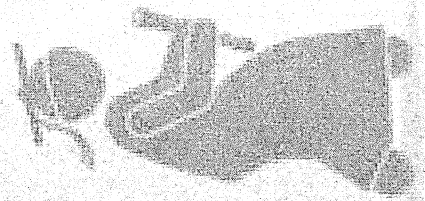
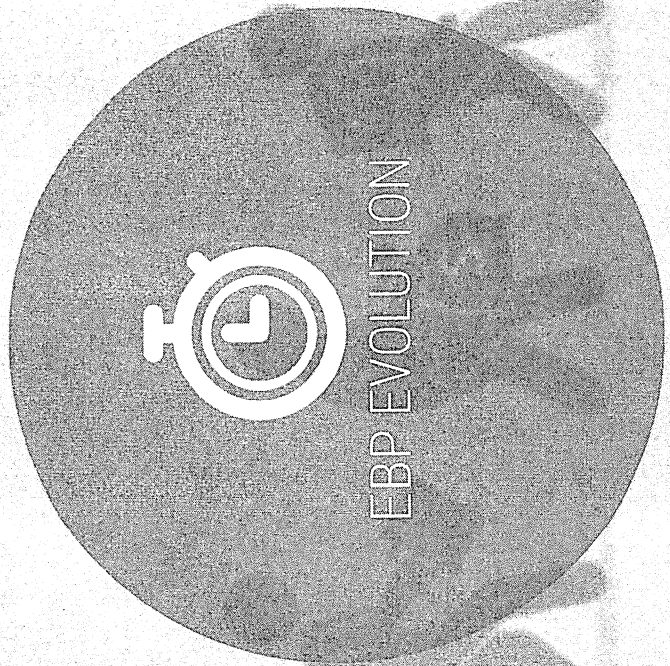

IT ALL BEGAN WITH JUSTICE REINVESTMENT...

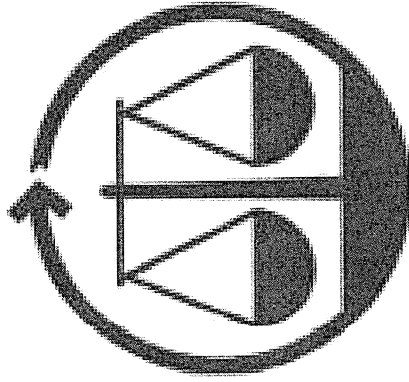

A data-driven approach to reduce corrections spending and reinvest savings in strategies that can decrease recidivism and increase public safety.

The Justice Reinvestment Initiative is supported by funding from the Pew Charitable Trusts and the U.S. Department of Justice's Bureau of Justice Assistance.

NEBRASKA'S JRI TIMELINE

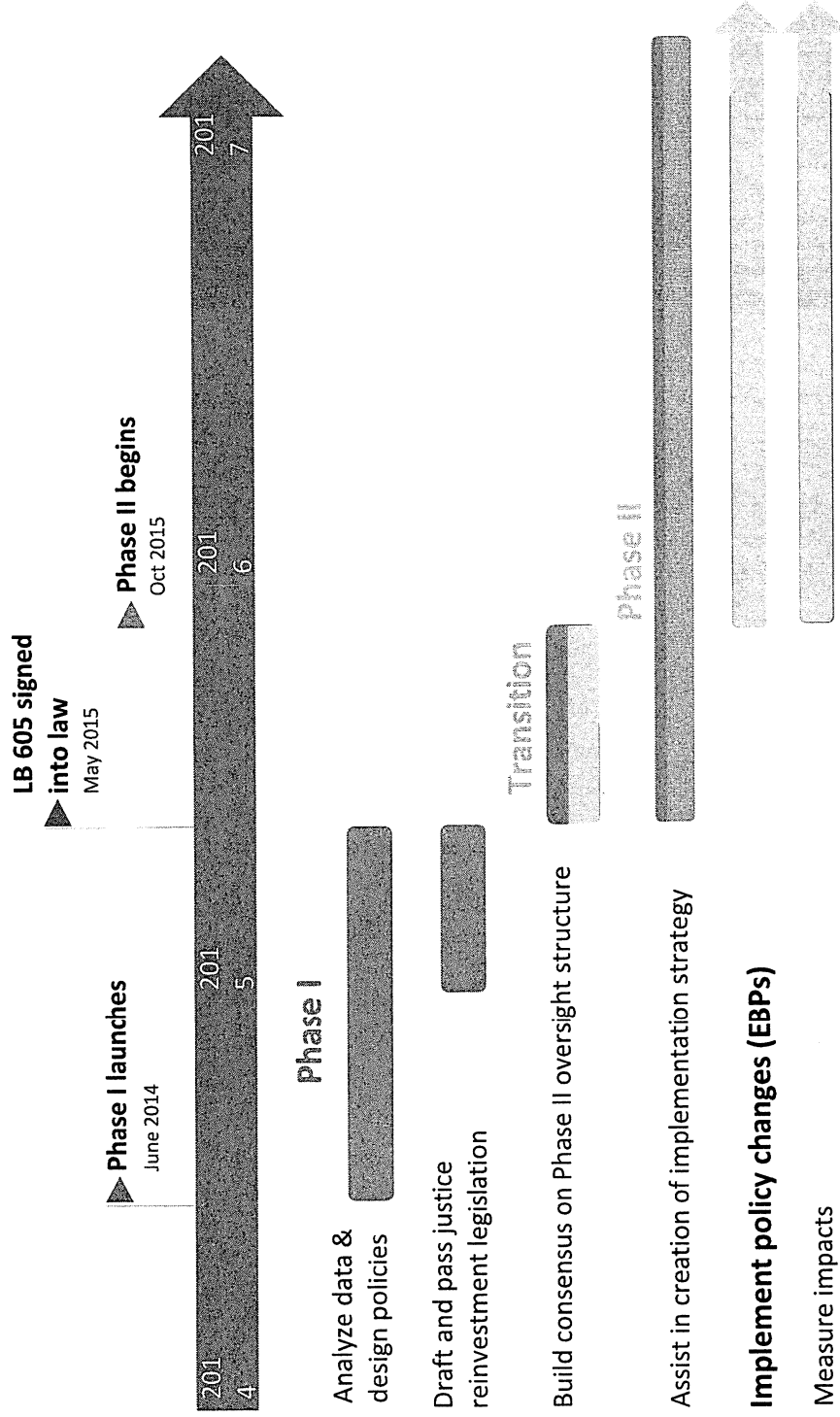

JRI ISSUES IDENTIFIED

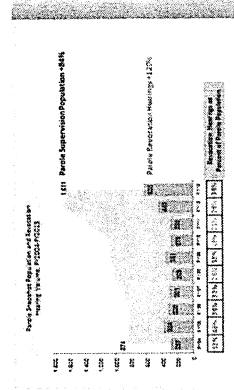

Population Growth on Parole

Without first implementing evidence-based practices, the parole supervision system had to manage a 49 percent increase in the parolee population since FY2010

- ✓ Dosage** - Parole supervision is not evidence-based. The population has increased 49% since FY10. Parole supervision is not evidence-based. The population has increased 49% since FY10. Parole supervision is not evidence-based. The population has increased 49% since FY10.
- ✓ Swiftmess** - Parole supervision is not evidence-based. The population has increased 49% since FY10. Parole supervision is not evidence-based. The population has increased 49% since FY10. Parole supervision is not evidence-based. The population has increased 49% since FY10.
- ✓ Consistency** - Parole supervision is not evidence-based. The population has increased 49% since FY10. Parole supervision is not evidence-based. The population has increased 49% since FY10. Parole supervision is not evidence-based. The population has increased 49% since FY10.
- ✓ Cost-effectiveness** - Parole supervision is not evidence-based. The population has increased 49% since FY10. Parole supervision is not evidence-based. The population has increased 49% since FY10. Parole supervision is not evidence-based. The population has increased 49% since FY10.

Increase in Parole Violator Admissions

Responses to parole violations lacked cost-effectiveness and the swiftmess necessary to change parolee behavior, and there had been a +130% in parole violator admissions to prison FY10-13

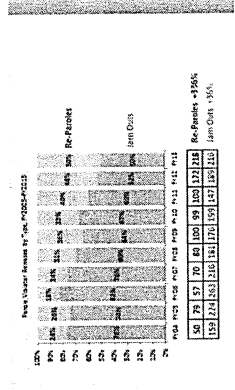

Jam Out after Violations

Parole violators revoked to prison were not required to return to supervision upon release

EVIDENCE-BASED PRACTICES

MEASURE & EVALUATE

Administrative staff and officers evaluate data to assess strengths and identify opportunities for client and staff development as well as agency growth

REINFORCE & SUPPORT

With the use of a sanctions and incentives matrix, officers provide behavioral reinforcement while also connecting clients with community supports

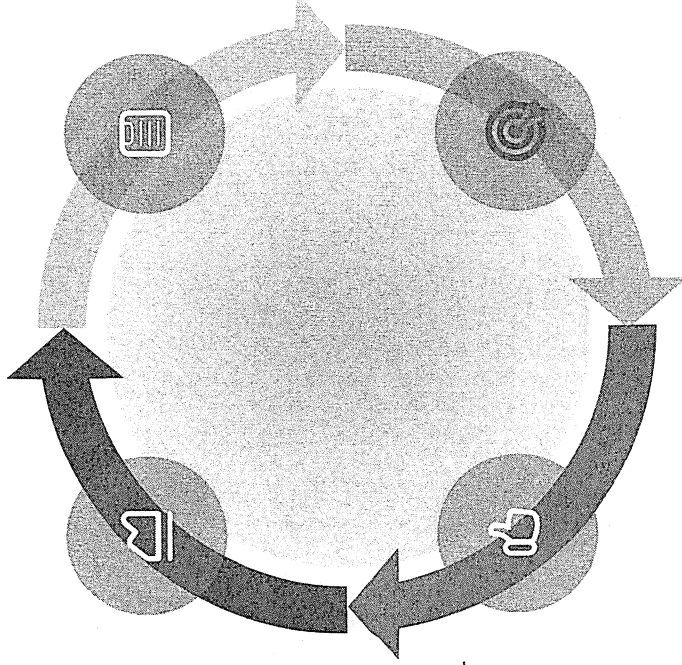

ASSESS & MOTIVATE

Officers conduct risk and needs assessments to identify drivers of criminal behavior and then work to motivate clients to change

TARGET & TRAIN

Using cognitive-behavioral techniques, officers target criminogenic needs and skill train clients using role modeling and directed practice

EBPS PAROLE NEEDED

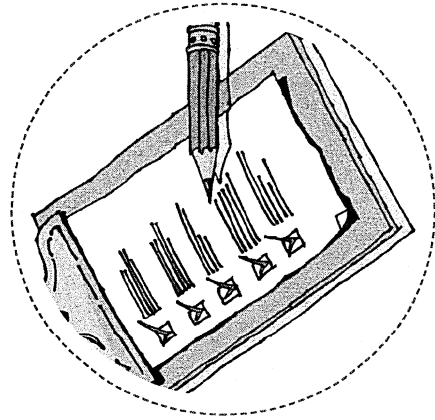

Risk Assessment

Adopt a risk assessment tool to assess risk for reoffending

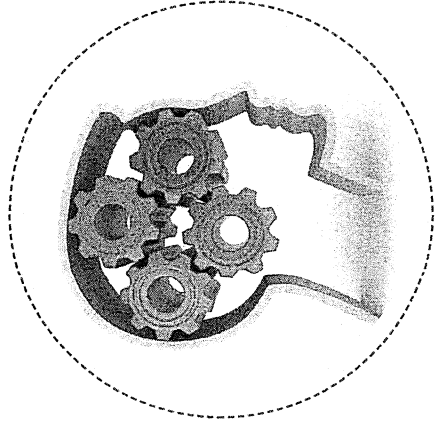

Address Thinking

Adopt and utilize EBPs to change criminal thinking and behavior



Need for Behavioral Management

Respond to parole violations with swift, consistent, and proportionate sanctions; also respond to positive behaviors with incentives

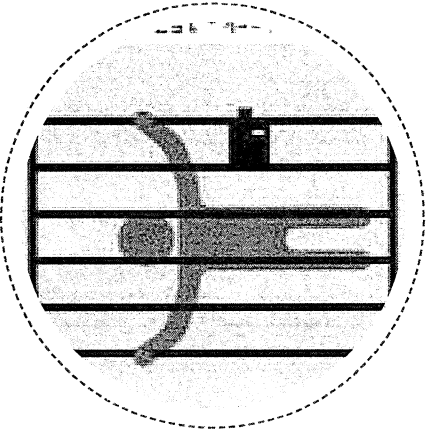

Custodial Sanctions

Respond to major parole violations with incarceration followed by supervision

RESULTS SO FAR:

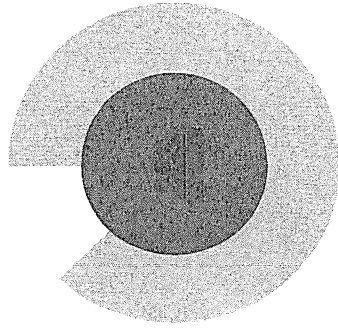

Reduced Revocation Hearings
by 15%

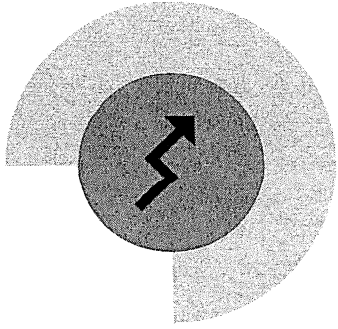

Reduced Technical Violation Hearings
by 25%

Evidence-based practices are reducing
revocations...

Since implementing our sanctions matrix, the number of revocation hearings has declined by 14.9%; that drop has come largely from the reduction of hearings for technical violations which decreased 24.9%. Sanctions are providing an effective response for technical violations of parole.

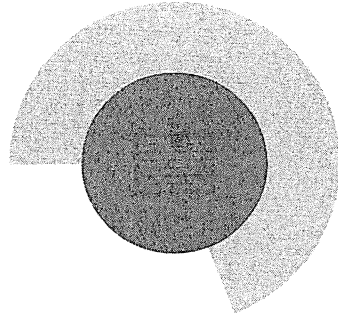

Recidivism Declined by 30%

...and we've seen a 30 percent decrease in
the number of parole clients recidivating in
the last two years.

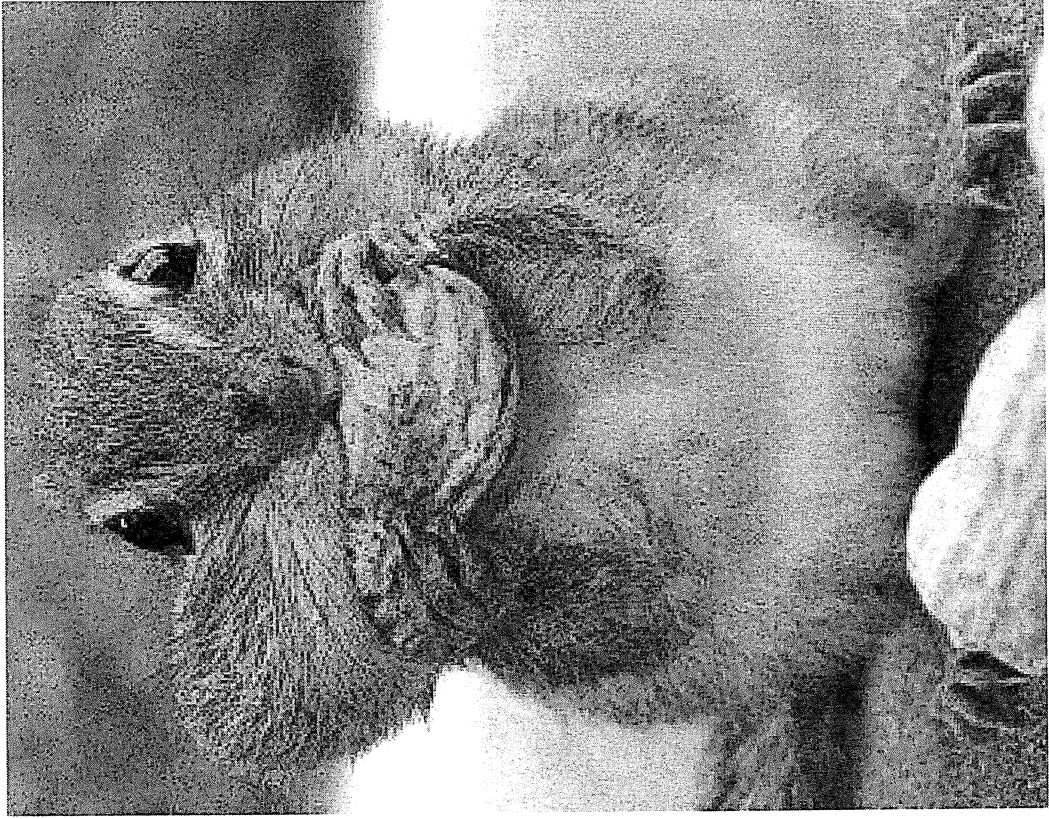

HOW WE DID IT

Your plan

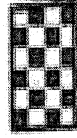
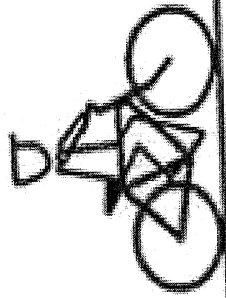

Reality

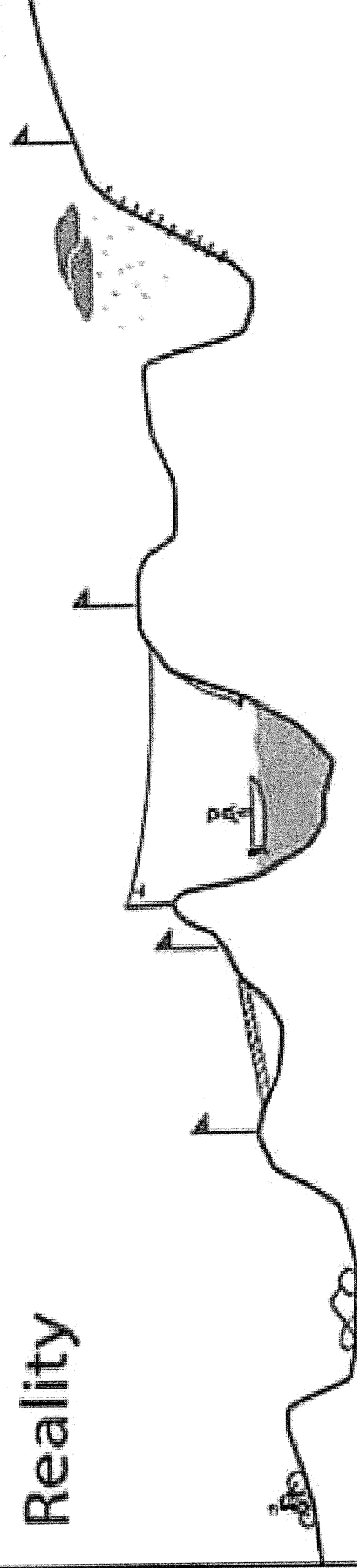

KEY PIECES

The successful implementation of our EBPs relied upon some key tools and foundational elements that made it possible to do this work



Technical Assistance

We worked together with CSG to exchange ideas, obtain coaching, and establish support with our implementation planning

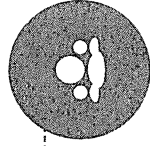

New Human Resources

New staff members were hired on and we directed their focus to factors like data management and analysis

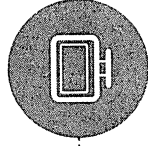

IT-Based Tools

A key feature of our implementation process was selecting web-based tools for use by our team

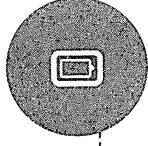

Data Dashboards

Along with our IT tools, we have worked hard to put the data at the fingertips of our staff to assist in their work

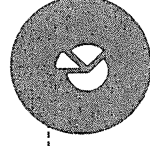

Quality Assurance

We explicitly developed quality assurance/continuous quality improvement processes and documents that are used to build individualized and agency training

OUR CHALLENGES

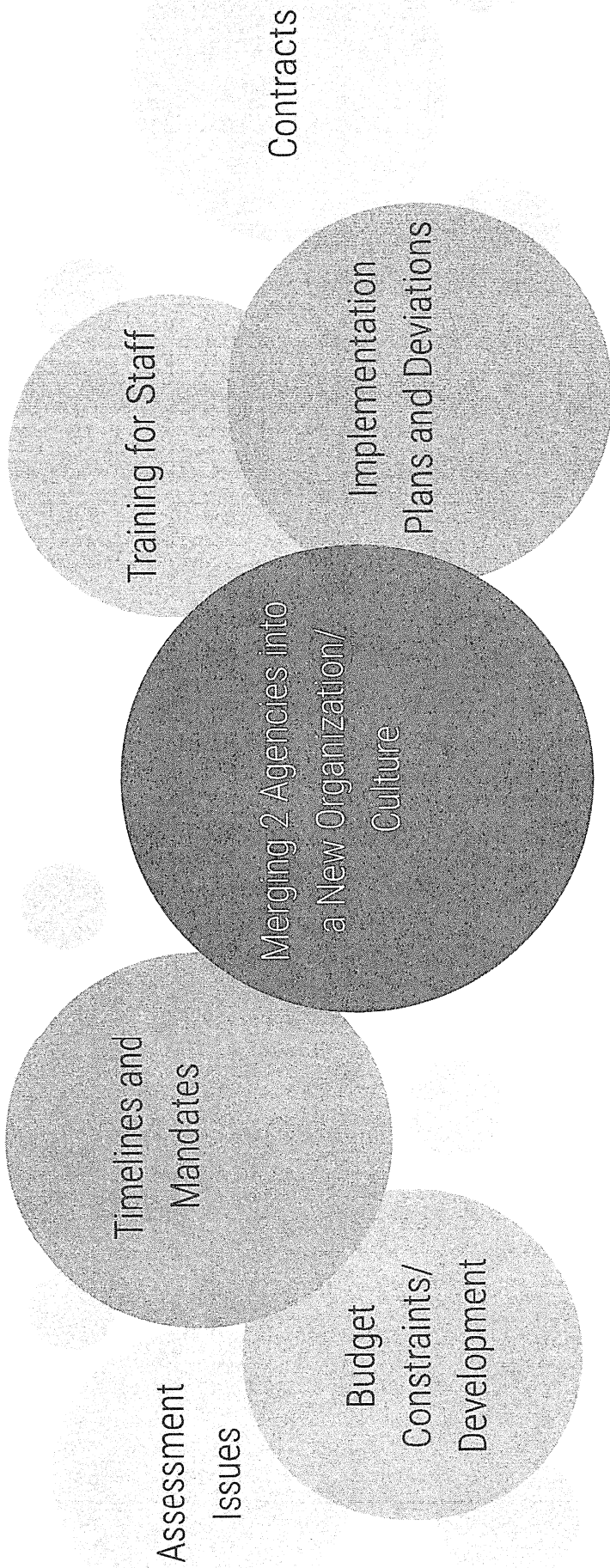

In conjunction with our EBPs to be implemented, we were tackling something even bigger—creating an entirely new agency from separate entities that had never coexisted under one roof including building our policies and protocols from the ground up...

SOLUTIONS!

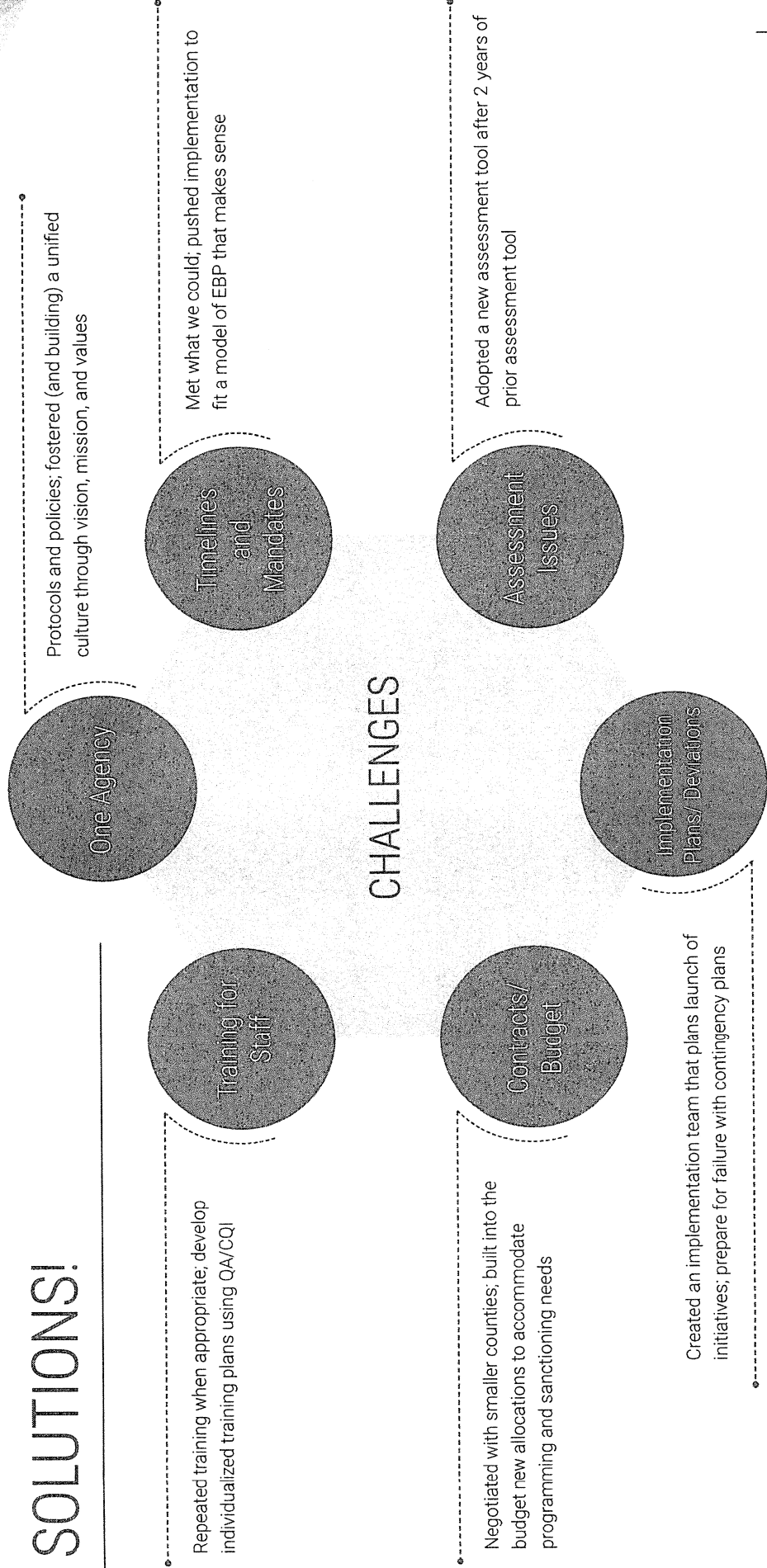

ACTUAL TIMELINE...

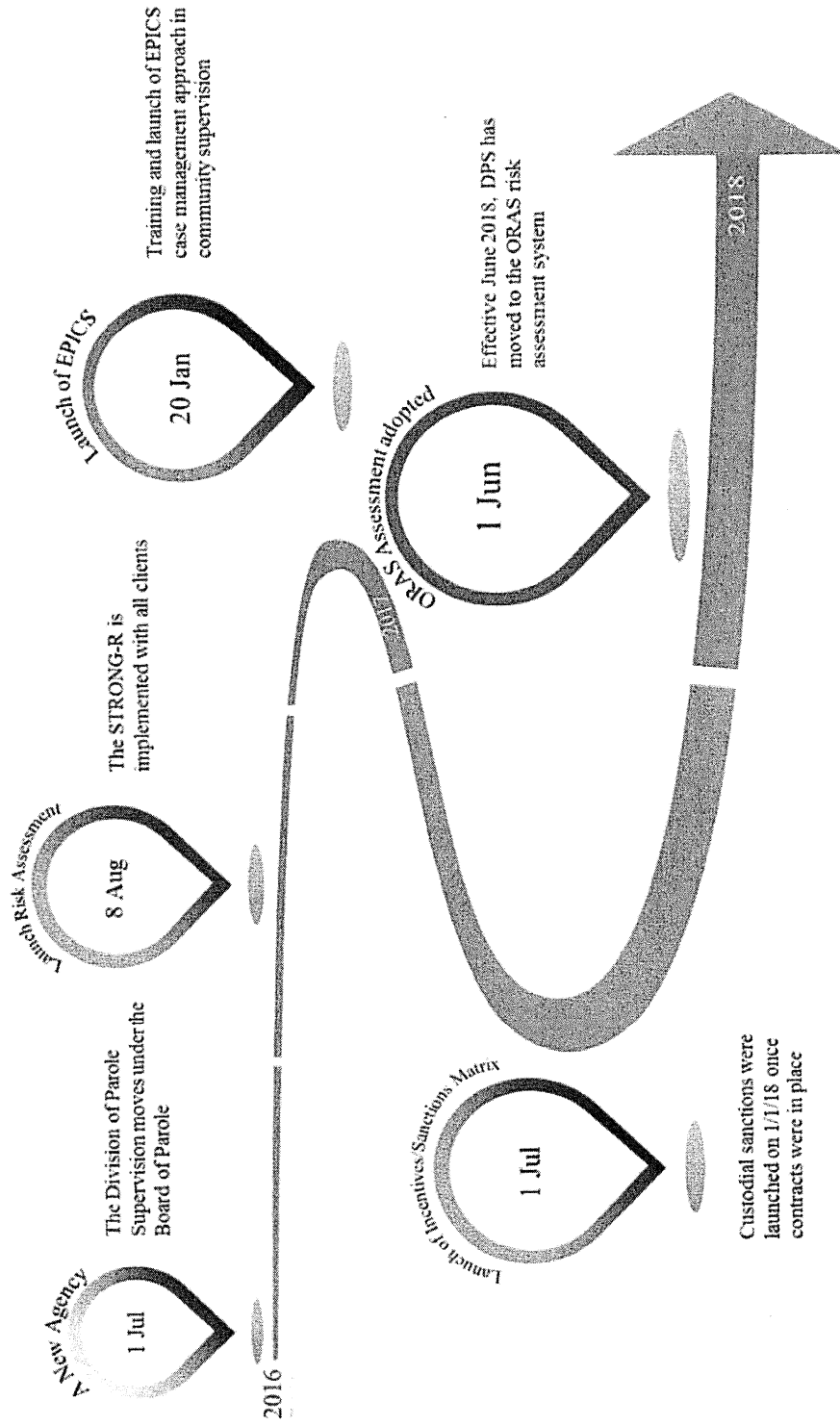

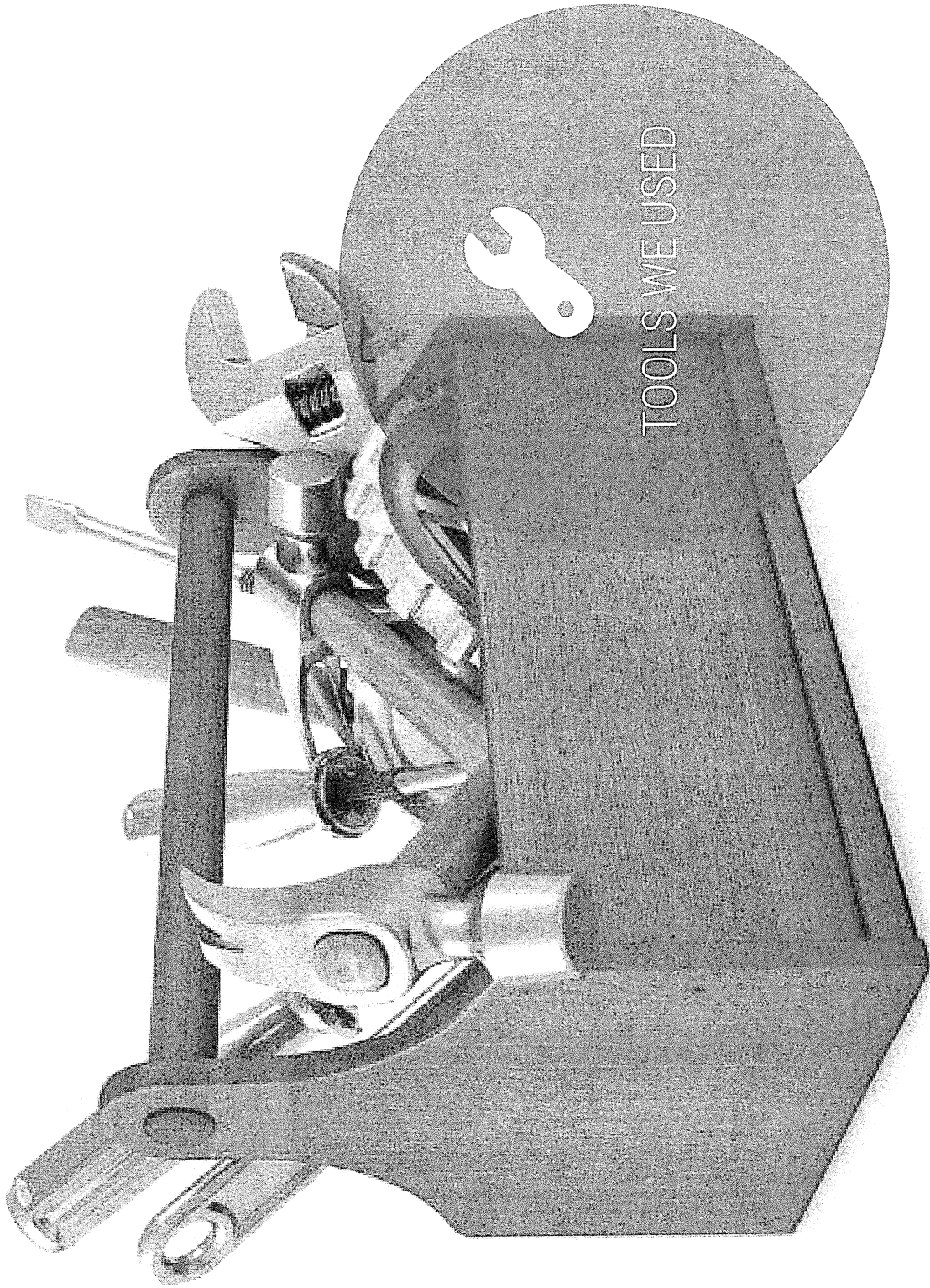

TOOLS WE USED

TOOLS IMPLEMENTED

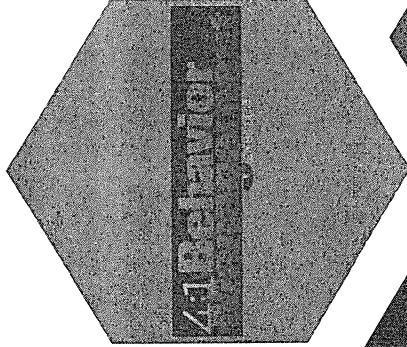

Carey 4:1 BMS System

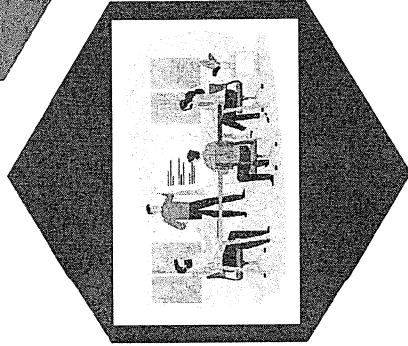

Quality Assurance and
Continuous Quality
Improvement Reports

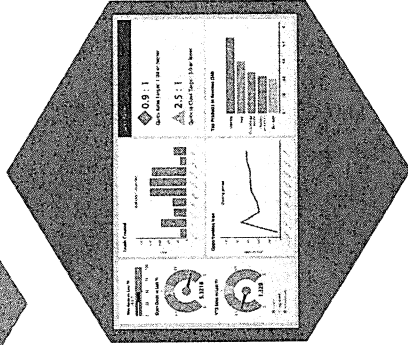

Data Dashboards

SHOW



AND

TELL

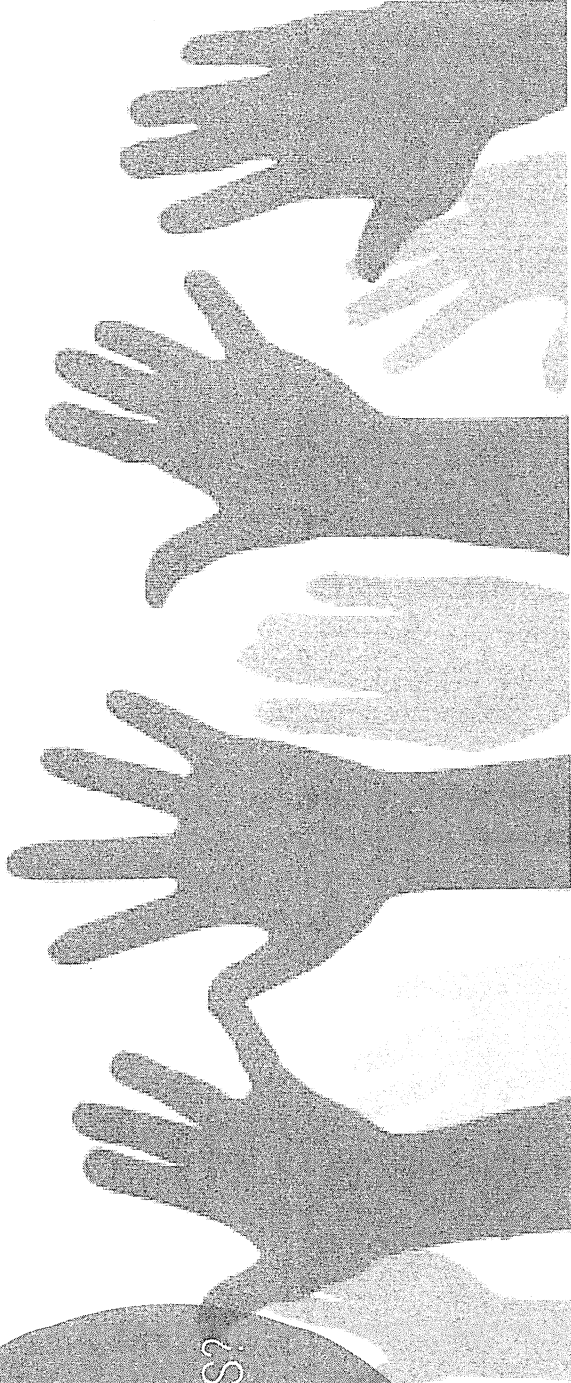
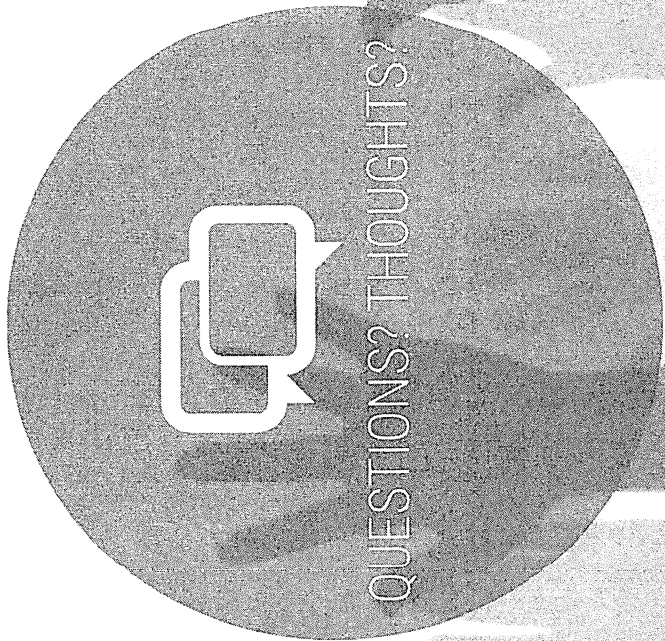

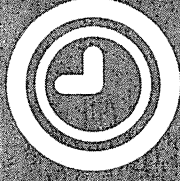
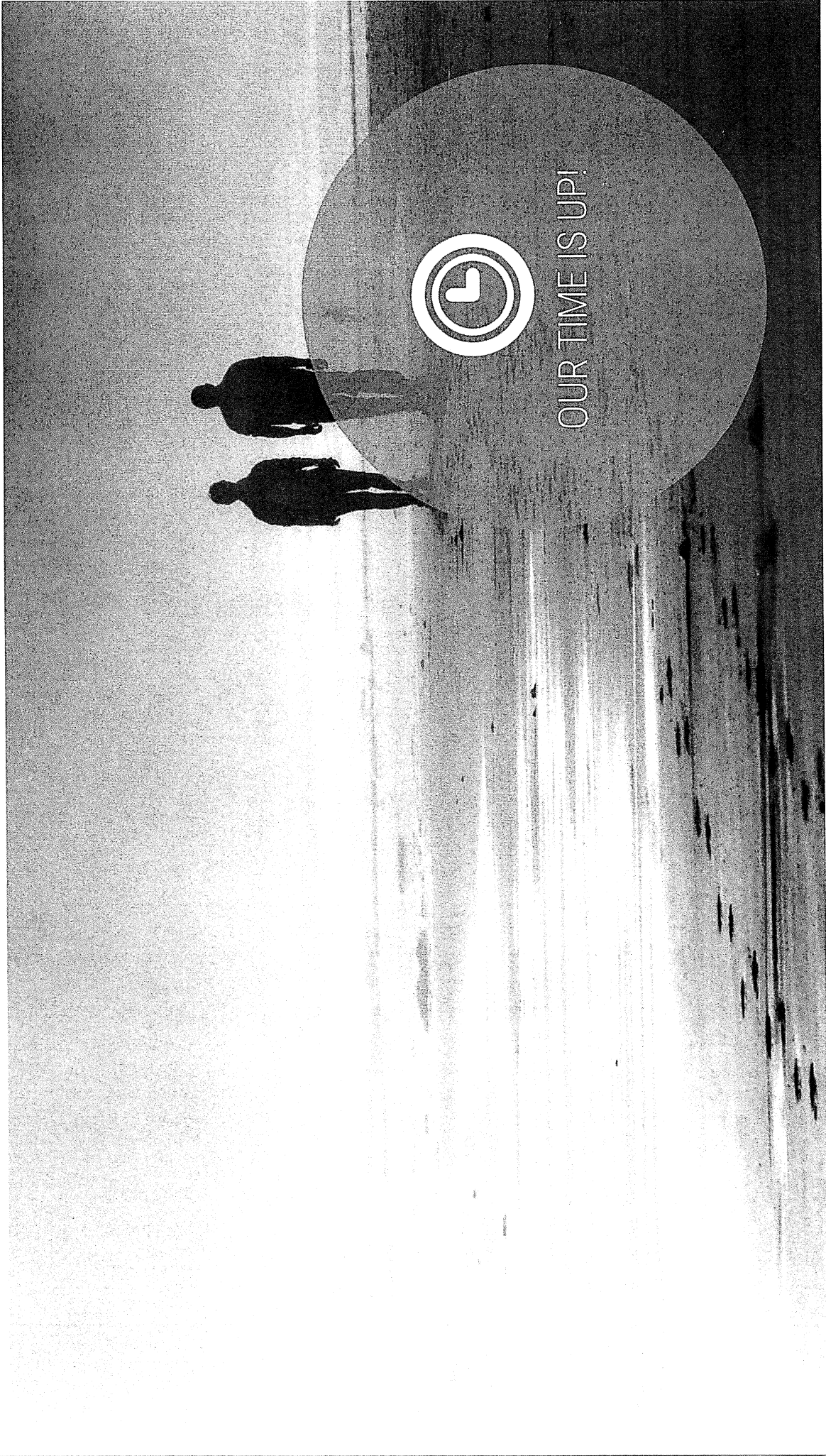

OUR TIME IS UP!

THANK YOU!

We are happy to answer any questions you have at this time
and to share our resources with all of you!

Additional Slides

BMS Sample Slides

4:1 Behavior SYSTEM

Help Logout

SYSTEM

Close Menus

Administration

Management Reports

Main

My Dashboard

Enter Behaviors/Responses

Customize Prosocial Responses

Run Reports

Manage Password

Main User's Guide

EBP Resources

Back to FIMS

My Dashboard

My Pending Actions

Behaviors Pending Responses by Me

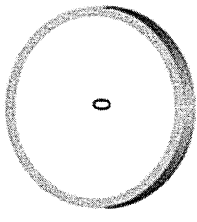

Behaviors Pending Responses by My Staff

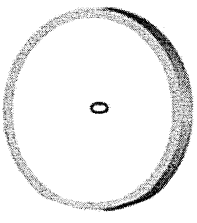

Departures Pending Approval by Me

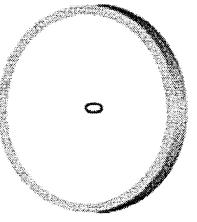

Responses pending within expected time period.

Responses pending outside the expected time period.

Supervisors' pending departure response within expected time period.

Supervisors' pending departure response outside expected time period.

My Caseload Overview

Clients I Supervise

Prosocial customization needed: 1 Individuals

Number of Active Clients:	2	Number of Inactive Clients:	0	My Ratios
Low	2	Low	0	Ratio of Prosocial Events to Noncompliance Events 1 : 1
Low-moderate	0	Low-moderate	0	Submit Ratio of Prosocial Behaviors to Noncompliance Behaviors 8 : 1
Moderate	0	Moderate	0	Submit Ratio of Prosocial Responses to Noncompliance Responses 5 : 1
High	0	High	0	

Enter Behaviors/Responses

Close Menu

Administration

Management Reports

Main

My Dashboard

Enter Behaviors/Responses

Customize Prosocial Responses

Run Reports

Manage Password

Main User's Guide

EBP Resources

Back to PLIMS

Select Staff

NICaMS Id

Or Search By Name



Jennifer Miller

Search Client

First Name

Inmate ID

Last Name

Search All

Search My Caseload

Search

Enter Behaviors/Responses

Management Reports

Main

My Dashboard

Enter Behaviors/Responses

Customize Prosocial Responses

Run Reports

Manage Password

Main User's Guide

EBP Resources

Back to PIMS

Select Staff

NICaMS Id

Jennifer Miller

Or Search By Name

RICHARD WALKER

[Edit Client](#)

[Proceed to Record Behaviors/Responses](#)

Risk Level Moderate
Date Placed 10/25/1966
Assigned to Denison Campbell

Criminogenic Needs
Criminal Attitudes and Behavioral Patterns
Family and Social Support
Substance Abuse
Neighborhood Problems

Current Active Period

Event Date	Response Type	Level	Behavior	Response	Level
04/25/18	Noncompliant	H	Narcotics: Refusal to Test	Substance Abuse Evaluation - Obtain and follow recommendations	M
10/13/17	10/13/17 Noncompliant	M	Employment/Education: Failure to secure employment within 30 days Narcotics	Cognitive behavioral program referral Written Directive - Other	M
10/13/17	10/13/17 Noncompliant	L	Finances/other: Failure to meet other financial obligation Residence: Changing residence without prior notice/approval	Increased Reporting up to 30 days Written Directive	L
10/13/17	10/13/17 Prosocial	N/A	Positive receptivity to case planning process	Removal of sanction	M
10/13/17	10/13/17 Noncompliant	M	Associates: While engaged in criminal behavior Associates: With person convicted of a crime Intoxicants Laws: Infraction (Requires Board Approval) Narcotics	Electronic Monitoring Increase reporting for up to 30 days Worksheet assignment (e.g., thinking report, Carey Guide Tool, BITS worksheet) Written Directive - Other	M

Select Behaviors/Responses

RICHARD WALKER

[Back to Client's Event Page](#)

Risk Level	Moderate	Criminogenic Needs	Criminal Attitudes and Behavioral Patterns
Date Placed	10/25/1966		Family and Social Support
Assigned to	Derison Campbell		Substance Abuse
			Neighborhood Problems

New Event

Event Date

Entered by Jennifer Miller

Select Prosocial Behavior Select Noncompliance Behavior

Select Behavior(s)

Search Behaviors

Search Behaviors

Clear Search

- Special Condition: SAP
- Associates: While engaged in criminal behavior
- Associates: With person convicted of a crime
- Communication Devices
- Community service: Failure to comply with community service requirements
- Directives: Failure to obey directives
- Employment/Education: Failure to secure employment within 30 days
- Employment/Education: Failure to maintain
- Finances/other: Failure to meet other financial obligation
- Financial: Failure to pay child support, restitution, fines
- Financial: Incurring Debt
- Financial: Programming Fees
- Intoxicants
- Intoxicants: Refusal to Test
- Laws: Failure to Report

- Special Condition: Sex Offender Special Condition 7
- Special Condition: Sex Offender Special Condition 8
- Special Condition: Take Medication as Prescribed
- Tampering or removal of electronic monitoring equipment or CAM
- Travel: Out of county without permission
- Travel: Out of State Without Permission
- Weapon:

Event Description:

Mr. X failed to report per the conditions of his parole.

Save

Enter Behaviors/Responses

Select Staff
 NICaMS Id **Jennifer Miller**
 Or Search By Name

RICHARD WALKER [Edit Client](#) [Proceed to Record Behaviors/Responses](#) [Back to PIMS](#)

Risk Level Moderate
Date Placed 10/25/1966
Assigned to Denison Campbell

Criminogenic Needs Criminal Attitudes and Behavioral Patterns
 Family and Social Support
 Substance Abuse
 Neighborhood Problems

Current Active Period

Event Date	Response Date	Type	Level	Behavior	Response	Level
08/20/19	08/20/19	Noncompliant	L	Laws: Failure to Report	Conference with Supervisor Increased Reporting up to 30 days	L edit
04/25/18	04/25/18	Noncompliant	H	Narcotics: Refusal to Test	Substance Abuse Evaluation - Obtain and follow recommendations	M edit
10/13/17	10/13/17	Noncompliant	M	Employment/Education: Failure to secure employment within 30 days Narcotics	Cognitive behavioral program referral Written Directive - Other	M edit
10/13/17	10/13/17	Noncompliant	L	Finances/other: Failure to meet other financial obligation Residence: Changing residence without prior notice/approval	Increased Reporting up to 30 days Written Directive	L edit
10/13/17	10/13/17	Prosocial	N/A	Positive receptivity to case planning process	Removal of sanction	M edit
10/13/17	10/13/17	Noncompliant	M	Associates: While engaged in criminal behavior Associates: With person convicted of a crime Intoxicants	Electronic Monitoring Increase reporting for up to 30 days Worksheet assignment (e.g., thinking report, Carey Guide Tool, BITS worksheet)	M edit

Administration

Management Reports

Main

My Dashboard

Enter Behaviors/Responses

Customize Prosocial Responses

Run Reports

Manage Password

Main User's Guide

EBP Resources

Back to PIMS

Stabilizing Departure/Destabilizing Departure

Management Reports

Main

My Dashboard

Enter Behaviors/Responses

Customize Prosocial Responses

Run Reports

Manage Password

Main User's Guide

EBP Resources

Back to PIMS

RICHARD WALKER

[Back to Client's Event Page](#)

Risk Level Moderate **Criminogenic Needs** Criminal Attitudes and Behavioral Patterns

Date Placed 10/25/1966 **Family and Social Support** Family and Social Support

Assigned to Derison **Substance Abuse** Substance Abuse

Campbell **Neighborhood Problems** Neighborhood Problems

Determined Response Level: Low

A lower-level response is not available in this case. Please return to the response options screen and select an appropriate response, or select "Upward Departure" from this screen.

Request for: Downward Departure Upward Departure

Stabilizing Factor Destabilizing

Stabilizing	Factor	Destabilizing
<input type="radio"/>	Acute Alcohol Intoxication	<input type="radio"/>
<input type="radio"/>	Attitude	<input type="radio"/>
<input type="radio"/>	Employment	<input type="radio"/>
<input type="radio"/>	Nexus with Offense	<input type="radio"/>
<input type="radio"/>	Prosocial Support System	<input type="radio"/>
<input type="radio"/>	Special Offender Category	<input type="radio"/>
<input type="radio"/>	Substance Use	<input type="radio"/>
<input type="radio"/>	Supervision Compliance	<input type="radio"/>
<input type="radio"/>	Time On Supervision	<input type="radio"/>
<input type="radio"/>	Violence or Threats	<input type="radio"/>

Stabilizing Departure/Destabilizing Departure

RICHARD WALKER

[Back to Client's Event Page](#)

Risk Level: Moderate **Criminogenic Needs:** Criminal Attitudes and Behavioral Patterns
Date Placed: 10/25/1968 **Family and Social Support**
Assigned to: Denison **Substance Abuse**
 Campbell **Neighborhood Problems**

Determined Response Level: Low
 A lower-level response is not available in this case. Please return to the [response options screen](#) and select an appropriate response, or select "Upward Departure" from this screen.

Request for: Downward Departure Upward Departure

Stabilizing	Factor	Destabilizing
<input type="radio"/>	Acute Alcohol Intoxication	<input type="radio"/>
<input checked="" type="radio"/>	Attitude	<input checked="" type="radio"/>
<input checked="" type="radio"/>	Employment	<input type="radio"/>
<input checked="" type="radio"/>	Nexus with Offense	<input type="radio"/>
<input checked="" type="radio"/>	Prosocial Support System	<input type="radio"/>
<input type="radio"/>	Special Offender Category	<input type="radio"/>
<input checked="" type="radio"/>	Substance Use	<input type="radio"/>
<input checked="" type="radio"/>	Supervision Compliance	<input type="radio"/>
<input type="radio"/>	Time On Supervision	<input checked="" type="radio"/> clear selection
<input type="radio"/>	Violence or Threats	<input type="radio"/>

Departures must be approved by supervisors.

Joel Denney (joel.denney@nebraska.gov) ▼

Notes to the Supervisor

Mr. X was just paroled on August 19, 2019 and failed to report in 24 hours.

Administration

Management Reports

Main

My Dashboard

Enter Behaviors Responses

Customize Prosocial Responses

Run Reports

Manage Password

Main User's Guide

EBP Resources

Back to PIMS

Close Menus

[Administration](#)

[Management Reports](#)

[Main](#)

[My Dashboard](#)

[Enter Behaviors/Responses](#)

[Customize Prosocial Responses](#)

[Run Reports](#)

[Manage Password](#)

[Main User's Guide](#)

[EBP Resources](#)

[Back to PIMS](#)

Noncompliance Response

RICHARD WALKER

[Back to Client's Event Page](#)

Risk Level

Moderate

Criminogenic Needs

Criminal Attitudes and Behavioral Patterns

Date Placed

10/25/1966

Assigned to

Denison
Campbell

Family and Social Support
Substance Abuse
Neighborhood Problems

* Pending Supervisor Approval *

Event Date: 08/20/2019

Entered by: Jennifer Miller

Behavior(s): Laws: Failure to Report

Determined Presumptive Response Level: Low

Response Level Change Requested: Upward

Requested Response Level: Medium

Update your departure request or resubmit.

[You may return Back to the Client's Event Page](#)

[Or return Back to the main Search Page](#)

Grid 4

		Risk Level			
		Low	Moderate	High	Very High
Severity of Violation	Low	Low Response	Low Response	Medium Response	High Response
	Medium	Low Response	Medium Response	Medium Response	Very High Response
	High	Medium Response	Medium Response	High Response	Very High Response
	Very High	Medium Response	High Response	Very High Response	Very High Response

OK

Dashboard

Data Filters

Date Range

From To

Agency

Unit Check All

- Unassigned
- Lincoln 1: Lincoln 1
- Lincoln 2: Lincoln 2
- Norfolk / SOLI - Norfolk / SOLI

Staff

Client

Status Active Inactive Both

Client

Gender

Risk Level

Race

Close Menus

Administration

Management Reports

- Dashboard
- Noncompliance
- Noncompliance Behaviors
- Noncompliance Responses
- Ratios
- Prosocial
- Prosocial Behaviors
- Prosocial Responses
- Prosocial Response Preferences
- Departures
- Departures Requested
- Departures Approved
- Departures Denied
- Stabilizing/destabilizing Factors
- Other
- Caseload Report
- Time Lapse
- Staff and Client Reports

Noncompliance Behaviors Compared to Prosocial Behaviors, by Month

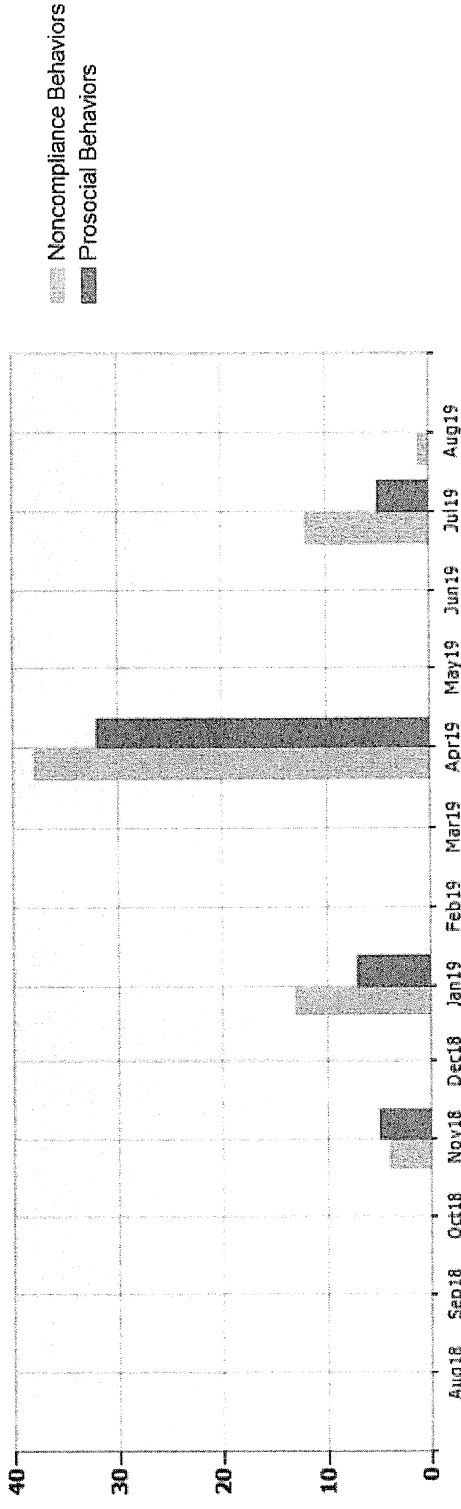

Noncompliance Behaviors Compared to Events, by Month

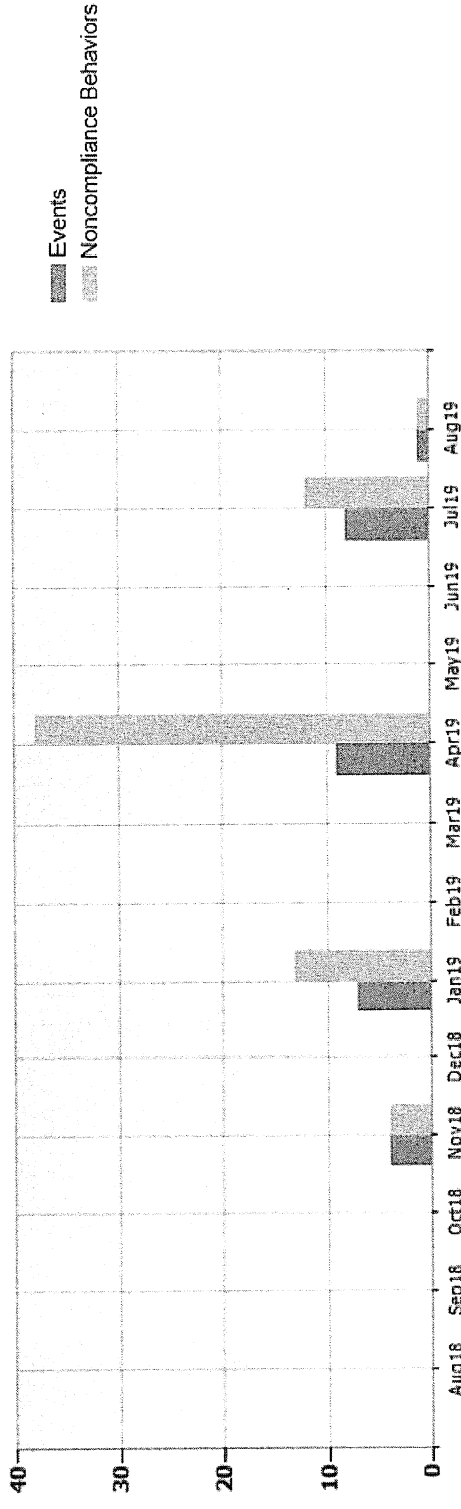



Prosocial Behaviors Compared to Events, by Month

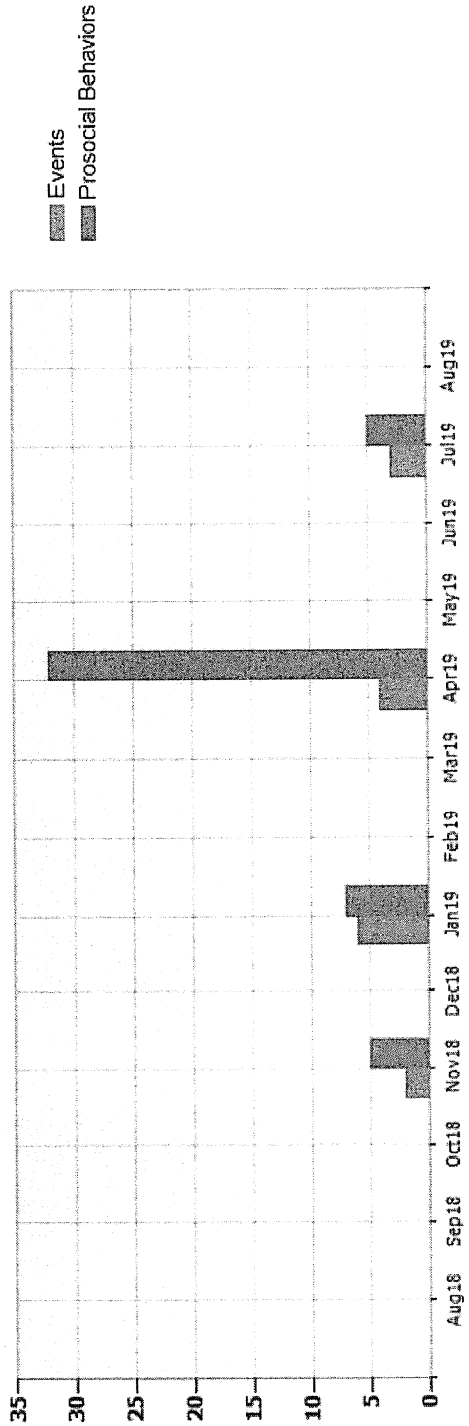

Top 10 Noncompliance Behaviors

[View raw numbers](#)

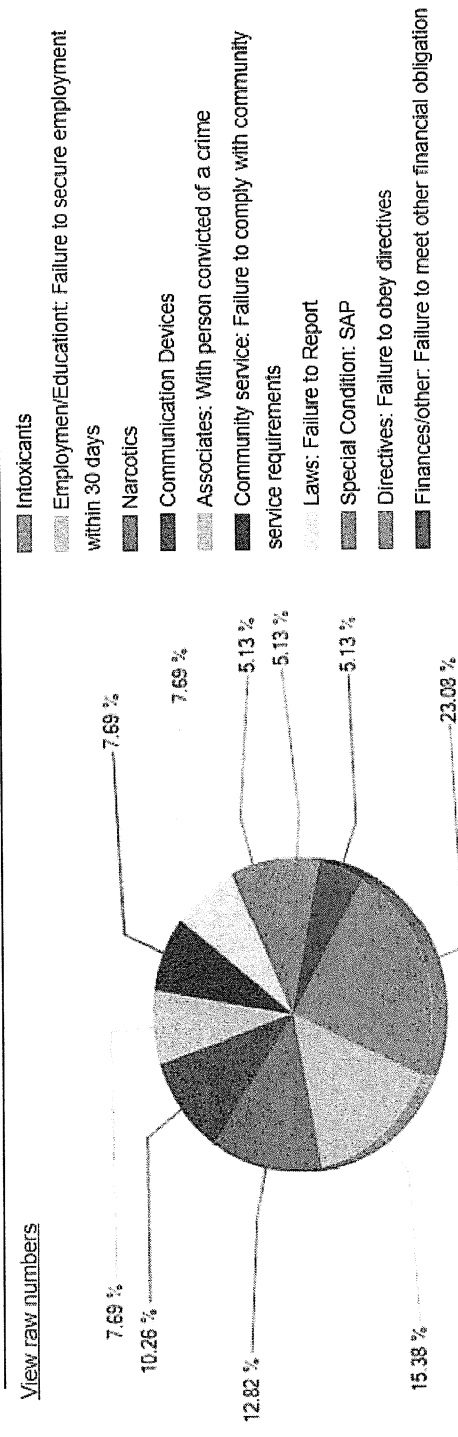

Dashboard

Sample Slides

Corrections DPS

PO Caseload EIM Collaterals Supervisors Client Audit LSO Admin/Data Records Interstates/QA Parole Pending Disc Actions ABSC/DET Lists AD Quinn Dir Micek Board History

Home Catalog Favorites Dashboards New Open Signed In As J MILLER

Parole Client Caseload

* Parole Officer Lopez, Oscar

Apply Reset

Count	ID Number	Inmate Name	Loct Prfx CD	Loct Suffix Dsc	Paroled	EDD	STG	Risk Score	Supervision Override	ORAS Done	Next ORAS Due	Address Line 1	City	Phone Number	Last Payment	Last Payment Date	Current Due
1	41684		PROL		10/26/2011	N	Low			3/14/2019	9/10/2019	1502 364th Street	Seward	(531) 209-0141	25.00	8/9/2019	0.00
2	54167		PROL		10/1/2018	N	Low			8/15/2019	2/11/2020	3820 Center St	Lincoln	402-304-9204	100.00	6/25/2019	-25.00
3	61624		PROL		5/22/2015	N	Low			4/25/2019	10/22/2019	202 Madison	Byron	(402) 200-8288	100.00	7/23/2019	-50.00
4	67374		PROL		6/29/2016	N	Low			7/16/2019	1/12/2020	819 Park Avenue	Milliford	(402) 803-9341	0.00	0/0/0	25.00
5	68335		PROL		10/5/2018	N	Low			4/16/2019	10/13/2019	614 East Avenue	York	(402) 363-8989	25.00	4/16/2019	100.00
6	68614		PROL		11/28/2017	N	Low			5/28/2019	11/24/2019	326 Marquies Street	York	(402) 710-8418	25.00	8/7/2019	0.00
7	69617		PROL		6/28/2016	Y	Moderate			3/29/2019	9/25/2019	422 E. 4th St	York	402-710-2790	125.00	7/9/2019	0.00
8	72469		PROL		11/12/2015	N	Low			3/14/2019	9/10/2019	1910 Valley View Drive	Crete	(402) 973-0222	50.00	4/24/2019	100.00
9	74396		PROL		7/12/2017	Y	Moderate			7/8/2019	1/4/2020	140 South Polk	Osceola	420-363-1350	40.00	7/31/2019	60.00
10	75645		PROL		10/25/2017	N	Low			6/13/2019	12/10/2019	125 North Wilson Street	Wilber	(402) 937-2067	100.00	6/21/2019	25.00
11	76383		PROL		4/18/2019	N	Moderate	High		5/2/2019	10/29/2019	219 7th Street	Fairbury	(402) 418-1111	50.00	7/16/2019	50.00

Corrections DPS

Upcoming EDDs

Office Location --Select Value--

Earn Dschrg Dt <=

OK Reset

Caseload by Parole Region (Supervisor)

PO Region Lincoln 1

Client Count by Location

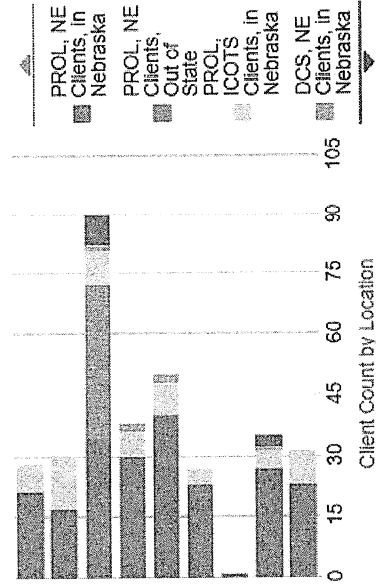

PO Region Omaha 1

Client Count by Location

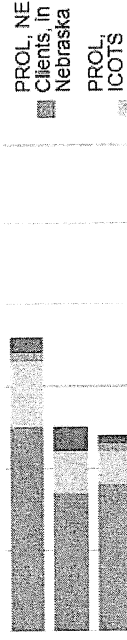

WORK QUEUE

ARREST-VIOLATION REPORTS

ID Number	Inmate Name	Report Date	Assigned PO	Last PO Email	Last Sprvsr Email	Last DPS Email	No. Board Approvals	Active
82021		8/19/2019		8/20/2019	8/20/2019	8/20/2019	2	Yes
85288		8/19/2019		8/19/2019	8/19/2019		0	Yes

Refresh - Print - Export

INTERSTATE CLIENTS

ID Number	Inmate Name	Report Date	Assigned PO	Last PO Email	Last Sprvsr Email	Active
104840		8/7/2019		8/7/2019	8/7/2019	Yes
104900		8/12/2019		8/12/2019	8/12/2019	Yes
104972		8/16/2019		8/16/2019	8/16/2019	Yes
104974		8/20/2019		8/20/2019	8/20/2019	Yes
105019		8/9/2019		8/9/2019	8/9/2019	Yes
105020		8/10/2019		8/10/2019	8/12/2019	Yes

NEBRASKA

Good Life. Great Communities.

S

December 31, 2018

To: Governor Pete Ricketts
Clerk of the Legislature Patrick O'Donnell

From: Julie Micek, Director of Supervision and Services, Nebraska Board of Parole/Division of
Parole Supervision

RE: Annual Report on Parole Revocations

Pursuant to Nebraska statute 83-1,102, please find attached the Annual Report on Parole Revocations and Technical Violations for Fiscal Year 2017 (July 1, 2017-June 30, 2018). This report was assembled by Dr. Jennifer Miller, the Assistant Director of Supervision for IT and Research for the Board of Parole. Any questions regarding specifics of this data can be directed to either myself or Dr. Miller.

Respectfully Submitted,

Julie Micek
Director of Supervision and Services
Nebraska Board of Parole

EXECUTIVE SUMMARY

The Board of Parole and the Office of Parole Administration are responsible for the oversight of clients who are placed on parole following an initial parole hearing by the Board. Oversight of these individuals includes the necessary step of holding clients accountable for violations of their terms of parole, including the possibility of revoking a client's parole and returning them to the custody of the Nebraska Department of Correctional Services. This report provides summary data on the incidence of review of parole hearings, the violations which prompted those hearings, and demographic data on individuals who were seen at these hearings. A brief summary of this data is as follows:

- In FY 2018, a total of 2,601 Nebraska clients were under community supervision by parole; 15.2 percent of those individuals had a review of parole hearing during the year.
- The Board of Parole scheduled and held 423 review of parole hearings in FY 2018 for 396 unique parole clients; four hearings were continued with the clients seen at a later date. Parole was revoked in 89.6 percent of those hearings for a total of 372 clients revoked (14.3 percent of the FY 2018 parole population). A total of 115 individuals were revoked and returned to custody until their mandatory discharge date. The Board has decreased the total number of review of parole hearings by 14.9 percent from FY 2017.
- Clients were continued on parole in 34 total hearings; of that number, 9 clients (26.5 percent) saw the board for a subsequent review of parole hearing during the same year at which time they were revoked.
- Approximately 58 percent of all review of parole hearings were prompted by a law violation; the remaining 42 percent of the hearings were prompted by technical violations of parole. The number of hearings held for technical violations decreased from 234 in FY 2017 to 176 in FY 2018, a relative decrease of 24.8 percent.
- The most prevalent parole violations that resulted in review of parole hearings were law violations and technical violations for narcotics possession or refusal to be tested.

The remainder of this report is broken down in the following manner: section I provides in-depth data regarding review of parole hearings, including the distribution of these hearings over time, the outcomes of these hearings over time, and data on deferral to mandatory discharges as well as on waived hearings. Section II provides detailed descriptions of the violations which bring about review of parole hearings; this section provides summary statistics regarding laws and technical violations, a breakdown of all violations considered during hearings, and an assessment of the relationship between violations and hearing outcomes. Section III delves into the demographic characteristics of parole clients seen at review of parole hearings. This section not only looks at standard demographic measures (age, racial identification, sex) but also includes data on how long clients were on parole before being seen at a review of parole hearing as well as previous parole revocations during the client's current sentence.

It is our hope that this data will facilitate greater understanding of the work that we do. We believe this information also illustrates our commitment to the state's mission to grow Nebraska in a way that preserves and protects public safety while also serving our clients. We welcome any and all feedback on this report and look forward to continuing service to our clients and our communities.

I. REVIEW OF PAROLE HEARINGS

From July 1, 2017 through June 30, 2018, the Nebraska Board of Parole scheduled a total of 423 review of parole hearings to consider the status of individuals who were determined to have significantly violated the terms of their parole agreement. A total of 419 hearings were completed and four hearings were continued to a later date. On average, the Board saw a total of 16 individuals on each day of parole review hearings, a 20% decrease from FY 2017. The distribution and count of these hearings by date is displayed in Figure 1 below.

Figure 1: Review of Parole Hearing Count by Date

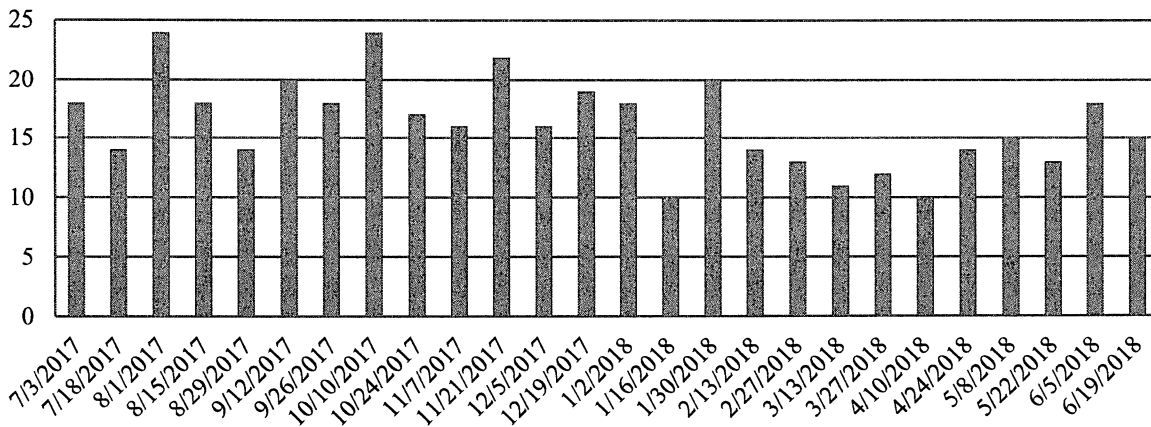

Of the review of parole hearings held in FY 2018, 379 hearings (89.6%) resulted in a motion to revoke parole. Motions to continue the client on parole were made in 34 hearings (8%) and motions to revoke and simultaneously re-parole were made in six cases total (1.4%). A total of 9 clients who were continued on parole at an earlier hearing during FY 2018 had their parole revoked at a hearing dated sometime later in the year. The distribution of these decisions over time is displayed in Figure 2 below.

Figure 2: Review of Parole Hearing Outcomes by Date

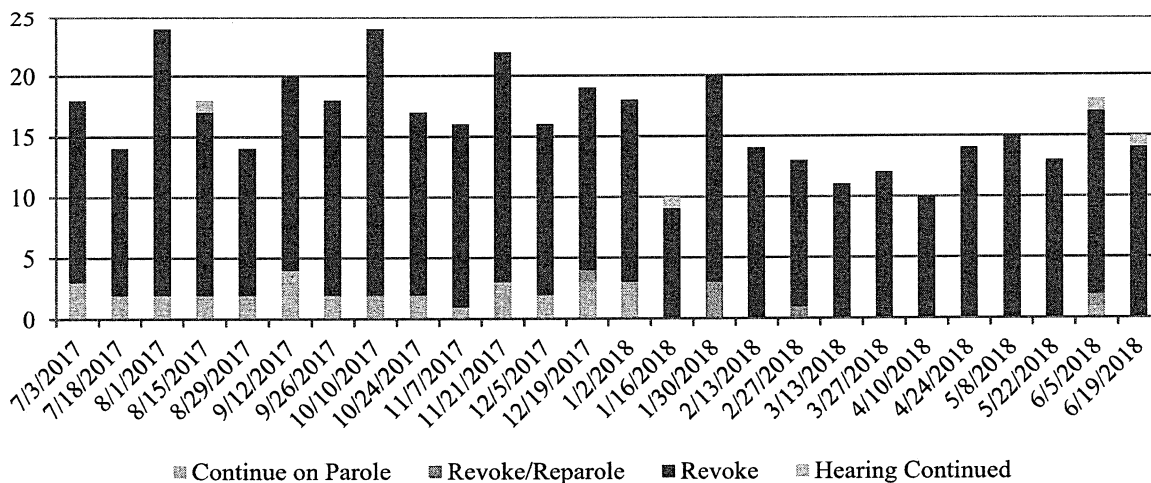

With respect to the decision to revoke a client’s parole, the Board also maintains the authority to defer that individual to their mandatory discharge date at which point the individual is released from the institution without any further opportunity for community supervision. In FY 2018, the Board determined that 115 individuals should be deferred to their mandatory discharge date; this constitutes 30.9% of all individuals who had their parole revoked.

For the vast majority of the revocation hearings, parolees are in attendance at the hearing. However, clients on parole are given the option of waiving their hearing if that is their preference. A total of 82 hearings were waived by parole clients during FY 2018. The outcome of all hearings that were waived was revocation of parole for that respective client.

II. PAROLE VIOLATIONS LEADING TO REVOCATIONS

Review of parole hearings are held for those individuals who have committed significant parole violations. Specific violations can be deemed as either laws violations (which includes the commission of new infractions, misdemeanors, and/or felonies) or technical violations (which includes any violation of the conditions of parole that is not a new criminal act).ⁱ Of the 419 hearings that were completed, a total of 243 (58%) had at least one law violation; the remaining 176 hearings were held for technical violations only (42%). In comparison with FY 2018, a total of 20 fewer hearings were held for laws violations and 58 fewer hearings were held for technical violations only. A breakdown of the general violation categories for all FY 2018 revocation hearings is shown below in Figure 3.

Figure 3: Violation Category Breakdown for FY 2018 Review of Parole Hearings

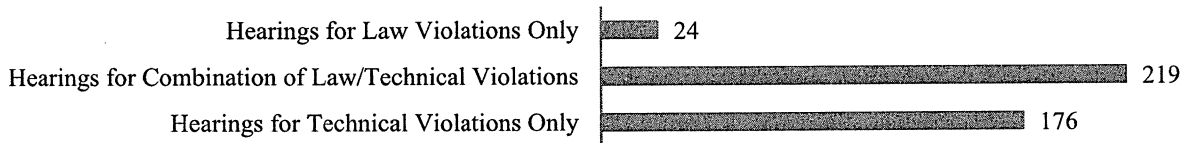

A total of 1,280 violations of parole conditions were identified in the 419 review of parole hearings completed in FY 2018. The average count of violations per hearing was 3; the count of violations ranges from 1-8 for all hearings during the year. The number of hearings that were held for each of the possible violation counts in this range is displayed below in Figure 4.

Figure 4: Number of Review of Parole Hearings Held by Number of Violations Per Client

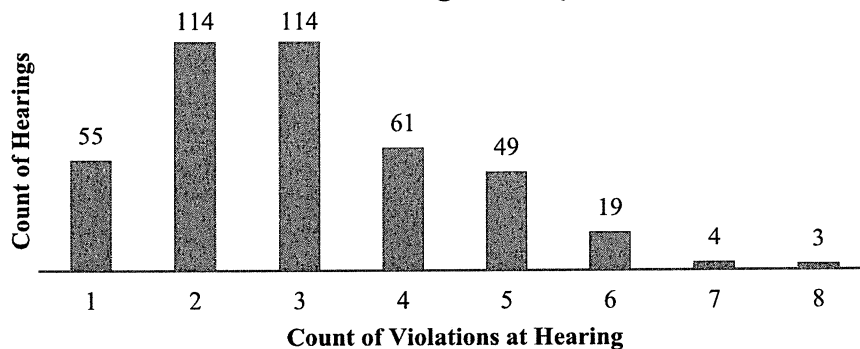

To fully understand the relationship between the hearings and the violations, it is necessary to investigate the results of hearings for law violations only, hearings for technical violations only, and hearings for combined technical and law violations. Figure 5 below presents a breakdown of the outcomes that were obtained for each of these different types of violations hearings. The graph below displays the percentage of hearings with specific types of violations (laws only, both laws and technical violations, or technical violations only) that had a decision of continue on parole, revoke and reparole, or revoke. The number of hearings for law violations only was 24, for laws and technical violations was 219, and for technical violations only was 176.

Figure 5: Hearing Outcomes by Violation Categories/Combinations

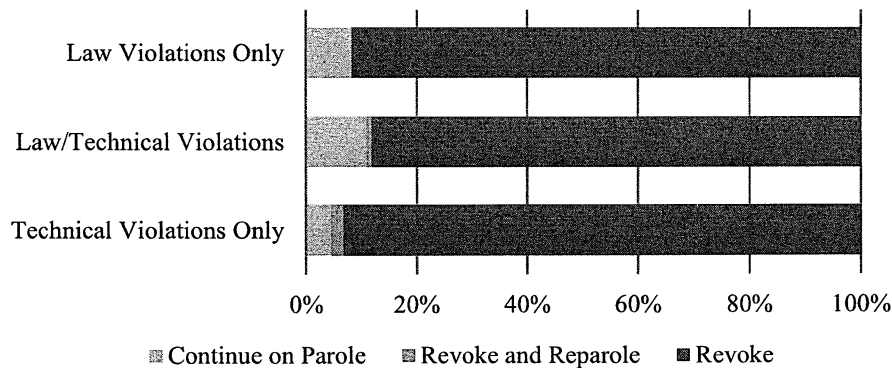

For clients who were revoked for technical violations only, 72 of the 168 clients (42.9%) were issued at least 1 sanction prior to being brought before the Board of Parole for a review of parole hearing. Of those 168, 76 (45.2%) have served a previous prison sentence prior to the sentence on which they were serving parole during FY 2018. In addition, 53 (31.5%) of the 168 clients revoked for technical violations had been re-paroled following earlier violations of a previous parole term either prior to or during FY 2018 on their current sentence.

III. REVOCATION DEMOGRAPHICS/CLIENT-BASED DATA

During FY 2018, the Board of Parole saw 396 unique parole clients at a total of 423 hearings.ⁱⁱ The demographic characteristics of these clients are summarized in Table 1 below; column 2 includes all hearings and provides comprehensive summary data while columns 3-5 provide the demographic breakdown based on the outcomes of review of parole hearings. With respect to these demographics, those who are seen at review of parole hearings are predominantly male, white, and under the age of 35. Data on clients who had review of parole hearings in FY 2018 also includes information on their tenure on parole (the duration of time they were on parole) prior to their review of parole hearing. This data is captured in Figure 6 below.

Table 1: Demographic Characteristics of Parole Clients/Review of Parole Hearings

Demographic Attributes	All Parole Clients (2,601)	All Hearing Clients (396)	Continued on Parole (34)	Revoked and Reparoled (6)	Parole Revoked (356)
SEX					
Female	394 (15.1%)	48 (12.1%)	1 (2.9%)	2 (33.3%)	45 (11.4%)
Male	2207 (84.9%)	348 (87.9%)	33 (97.1%)	4 (66.7%)	311 (78.5%)
RACIAL IDENTIFICATION					
African-American/Black	561 (21.6%)	99 (25.0%)	5 (14.7%)	2 (33.3%)	92 (23.2%)
Asian/Pacific Islander	24 (0.9%)	6 (1.5%)	1 (2.9%)	-	5 (1.3%)
Caucasian/White	1636 (62.9%)	228 (57.6%)	21 (61.8%)	3 (50.0%)	204 (51.5%)
Hispanic	256 (9.8%)	36 (9.1%)	4 (11.8%)	-	32 (8.1%)
Native American	100 (3.8%)	23 (5.8%)	2 (5.9%)	1 (16.7%)	20 (5.1%)
Other/Unknown	24 (0.9%)	4 (1.0%)	1 (2.9%)	-	3 (0.8%)
AGE					
16-20	27 (1.0%)	11 (2.8%)	1 (2.9%)	-	10 (2.5%)
21-25	325 (12.5%)	66 (16.7%)	6 (17.6%)	-	60 (15.2%)
26-30	446 (17.1%)	78 (19.7%)	10 (29.4%)	-	68 (17.2%)
31-35	463 (17.8%)	80 (20.2%)	6 (17.6%)	-	74 (18.7%)
36-40	400 (15.4%)	56 (14.1%)	4 (11.8%)	2 (33.3%)	50 (12.6%)
41-50	504 (19.4%)	73 (18.4%)	5 (14.7%)	2 (33.3%)	66 (16.7%)
51 or older	436 (16.8%)	32 (8.1%)	2 (5.9%)	2 (33.3%)	33 (8.2%)

Figure 6: Number of Clients with Review of Parole Hearings by Duration on Parole

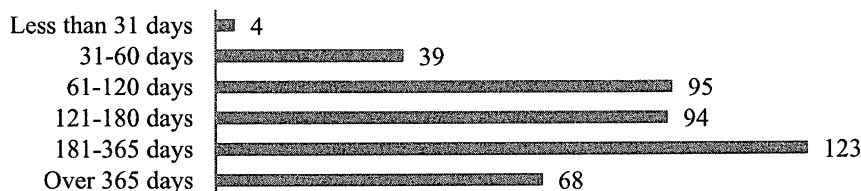

The final data presented in this report regarding clients who were seen at review of parole hearings pertains to their type of parole—specifically whether these clients had been reparaoled prior to their revocation hearing or whether they were on their first term of discretionary parole and had not previously been revoked on the current sentence. Of the 396 clients with hearings held in FY 2018, 110 clients (27.8%) were on reparaole, meaning that they had been revoked at some prior point in time but had been returned to community supervision following that revocation. The remaining 286 (72.2%) clients that had not previously been revoked or faced a prior review of parole hearing on their current sentence.

IV. CONCLUSION

This report has focused solely upon the practices surrounding the handling of violations of parole and the use of review of parole hearings to determine whether parole clients should continue to remain on community supervision. Practices of the Board of Parole and Division of Parole Supervision have continuously moved toward finding ways to keep more clients actively on

NEBRASKA

Good Life. Great Communities.

community supervision, rather than return them to the custody of NDCS, through the use of graduated penalties (including sanctions) and by continuing individuals on parole if they are deemed as likely to succeed on parole. The Division of Parole Supervision implemented its sanctions matrix and custodial sanctions after FY 2017 and it has already shown great promise in FY 2018. A decrease of 20% in overall hearings alongside a sizeable decrease in the number of hearings prompted by technical violations only point to the effectiveness of these graduated sanctions. Beginning in January 2018, custodial sanctions were made available as an option to parole officers across the state; we anticipate the use of these sanctions will further contribute to the positive trends we have witnessed to date.

It is critical to clarify that while sanctions for parole violations and review of parole hearings are important tools at the disposal of the Board and the Division of Parole Supervision, these are not tools used with the vast majority of parole clients. In FY 2018, a total of 2,601 Nebraska parole clients were on community supervision under the Board of Parole. Of that number, 761 (29.3%) had a review of parole hearing at some time during their parole tenure and 725 (27.9%) actually had their parole revoked. Sanctions, review of parole hearings, and revocations therefore constitute a significant proportion of the work done by the staff at the Division of Parole Supervision but are not used with the majority of those who are on community supervision. As we evolve as an independent agency, we look forward to further solidifying our evidence-based practices and tools to help further reduce parole sanction and revocation numbers while serving our clients and preserving public safety.

ⁱ Although the distinction between law and technical violations may seem apparent, the technical conditions of parole overlap with existing laws. For instance, individuals on parole may be charged with a laws violation for possession of a controlled substance or they may be charged with a technical violation for narcotics possession if they are not apprehended by law enforcement for possession (parole clients often admit to possession or use of substances but do not receive new charges pertaining to those substances due to a lack of arrest).

ⁱⁱ Four clients had hearings that were continued at a later date than their originally scheduled hearing and 23 individuals had multiple (two) revocation hearings over this time period with a decision of continue, revoke and re-parole, or revoke.

Source	Recommendations	July 2017 Status	July 2018 Status	July 2019 Status
<p>2016 Annual Report</p>	<p>Convene a work group on staff retention that includes people in positions throughout NDCS and individuals from outside NDCS</p>	<p>Various processes have been used to identify and implement strategies to improve retention. This concept has merit, but we have collected significant information from staff through the culture survey and the surveys conducted by the IG. Salary increases, leadership training, and various bonuses have had some impact on retention, but the overall effect is difficult to measure. HR is currently working with DAS to find new ideas.</p>	<p>Despite numerous strategies responsive to issues identified by agency, staff retention is still a challenge. Retention workgroup will be formed by October 2018.</p>	<p>Retention work group report shared. Project provided information consistent with other information collecting efforts over the years. Current initiatives to address compensation and leadership skills consistent with areas identified as being the greatest need.</p>

<p>2016 Annual Report</p>	<p>Present salary proposals to the Department of Administrative Services that would either result in longevity pay or the establishment of a tiered plan system where an employee can be rewarded for reaching certain work goals, achievements or certifications. For example, positions of Corporal I, Corporal II, and Corporal III could be created. To move from one tier to the other the individual would have to be in their position for a certain period of time, take outside classes, gain a special certification or accomplish goals established by NDCS. Health services staff could achieve something similar if they receive a form of health professional certification</p>	<p>A merit pay option was negotiated during the last bargaining session. We will push for funding in the next negotiation session. This is a mandatory subject of bargaining.</p>	<p>Still working on funding/implementing the custody staffing audit. With full implementation a tiered approach may be an option - it was successful in Washington state. Collective bargaining occurs this fall, and compensation will be on the table.</p> <p>Implementation of various forms of longevity/merit pay have been negotiated or authorized for about 80% of the staff within NDCS. Efforts continue to make this the practice throughout the agency. FY20-21 Agency budget includes 48 more positions connected to the staffing analysis.</p>
<p>2016 Annual Report</p>	<p>Provide additional pay for employees who participate in extra duties that require additional training</p>	<p>Subject of bargaining.</p>	<p>Subject of bargaining. Have implemented a bonus plan for supervisors to incentivize efforts towards staff engagement.</p>

2016 Annual Report	Contact the Department of Administrative Services and begin the process of seeking a reclassification of correctional nurses (including Registered Nurses and Licensed Practical Nurses)	There is no reclassification option that is applicable to my nursing staff. The concept of correctional health care remains an longer term option to recognizing the special work conditions/patient load.	Work continues on the correctional health care designation (staff are working on certification)	Some staff have achieved certification, efforts continue to address compensation issues within healthcare.
2016 Annual Report	End the \$250 bonus program that is part of the \$1.5 million retention plan and use the remaining funds to provide bonuses to employees who did not receive the \$500 bonus that was announced in August 2016	Didn't agree.	no change	
2016 Annual Report	Place limits on the amount of overtime that an employee can work in one week	Subject of mandatory bargaining, not feasible under current staffing challenges	no change	
2016 Annual Report	Consider the banning of back to back 16 hour shifts by employees	Subject of mandatory bargaining, not feasible under current staffing challenges	no change	
2016 Annual Report	Provide quarterly updates to the Legislature and the Inspector General for Corrections on turnover rates, vacancy rates, and overtime data for all classifications of positions	We are providing an updated quarterly data report beginning July 31st. If any of this information is not covered, it will be provided upon request.	Revised quarterly data sheet includes information agreed upon.	
2016 Annual Report	Place a renewed focus on improving communication between behavioral health administration and staff	Done		

<p>2016 Annual Report</p>	<p>Review attempts in other correctional agencies to bring “new blood” into their agencies and develop short-term and long-term plans to do that for NDCS</p>	<p>With our turnover we are constantly bringing in “new blood”. Compensation levels for most positions do not attract candidates from other states.</p>	<p>Efforts continue</p>	
<p>2016 Annual Report</p>	<p>Continue to develop more program options for inmates that would assist them in being paroled, including the development of programs provided in foreign languages</p>	<p>The work continues.</p>	<p>Assessments are happening sooner, capacity for CBI programs greatly expanded, clinical treatment capacity has expanded, VLS programs producing significant results, pro-social activities greatly expanded. The goal is to give everyone the opportunity to be ready for parole by PED.</p>	<p>The quantity and quality of programming has increased significantly since 2015, and the efforts will continue.</p>
<p>2016 Annual Report</p>	<p>Complete a staffing analysis for the entire Department of Correctional Services</p>	<p>Of no value at this time, and in light of the actions taken by the LR34 committee in this budget session – it could be years before there is any value in doing any further assessment.</p>	<p>Legislation passed in 2018. A full staffing analysis will be completed by December 2020. Funding and implementing the custody staffing model remains the top priority for staffing.</p>	<p>no change</p>
<p>2016 Annual Report</p>	<p>Provide regular updates to the Legislature and the Inspector General of Corrections regarding any changes that are made as a result of the Culture Survey</p>	<p>I’m not resourced to report on everything we are mandated to report on. I’m not going to add additional reporting on work that we initiated.</p>	<p>Efforts to change the work culture continue.</p>	<p>Initiated new partnership with Gallup focused on employee engagement</p>

<p>2016 Annual Report</p>	<p>Continually review placements of inmates in the county jail program to check that the inmates who are placed there actually are qualified to participate in the program</p>	<p>We do.</p>	<p>It is not a program. We rent beds from jails to house people, primarily short term (typically less than 90 days) unless the inmate requests to stay or as an alternative to restrictive housing because of protective custody needs. Current average length of stay is 77 days.</p>
<p>2016 Annual Report</p>	<p>Establish a goal to implement the restrictive housing peer support pilot program no later than October 1, 2017</p>	<p>I plan to meet the date in the AR.</p>	<p>The date set in statute was met with a pilot program underway at NSP. It is a promising practice and I expect to expand use of the concept over the next two years.</p> <p>Efforts continue, with enhanced training/certification at NSP and training started at TSCI</p>
<p>2016 Annual Report</p>	<p>Convene a work group on communication that includes people in positions throughout NDCS and individuals from outside NDCS including former inmates. The focus would be to address how NDCS administration can communicate more efficiently and effectively with staff and inmates</p>	<p>We are not resourced to form all the work groups that I would like to form. This is a good idea, but it hasn't risen to the top of the priority list.</p>	<p>Improved communication is always a top focus of the agency. The engagement project with Gallup will help staff members connect and communicate in ways they have not had the opportunity before</p> <p>A variety of projects/activities have helped address this issue. Communication is always a work in progress.</p>

<p>2016 Annual Report</p>	<p>Provide the Inspector General of Corrections and the members of the Nabarro suicide Critical Incident Review Team with regular updates on the progress of the recommendations made in the Critical Incident Review. NDCS should also do this for all Critical Incident Reviews that are done in the future</p>	<p>Critical Incident Reviews are internal tool used to improve processes. We will provide copies of the finalized CIRs when requested, and be responsive to questions. I'm not willing to create an external reporting process for an agency work tool.</p>		
<p>2016 Annual Report</p>	<p>Provide additional transparency regarding accountability for the conditions that led to the escapes from the Lincoln Correctional Center on June 9, 2016</p>	<p>We shared all information with you.</p>		

<p>2016 Annual Report</p>	<p>Develop a plan that would allow female inmates to be able to utilize community custody beds in the Omaha area after the female beds at the Community Corrections Center-Omaha cease to exist</p>	<p>As I continue to learn more about female offenders I'm convinced that our approach of consolidating female community beds is the smartest, most effective way to give female offenders a safe, therapeutic, and reentry focused transition. These are people that have experienced significant life trauma, have high mental health needs, and are not going to succeed simply by getting a minimum wage job in Omaha. The value of work release is having a chance to put enough money away to pay for housing and basic needs upon release. The value of a gender based therapeutic reentry center far outweighs going to work release out by the Omaha airport.</p>	<p>Looking forward to opening the new unit next year. The project is on schedule.</p>	<p>Current number of community custody beds for females exceeds the available population of female community custody inmates, and will for a few years. New living unit is open, and has been very well received by the women housed there</p>
<p>2016 Annual Report</p>	<p>Review options pertaining to using county jails as work release placements for people who will be transitioning to areas near those county jails</p>	<p>Have an agreement with Scottsbluff – will continue to explore this idea.</p>	<p>With our commitment to build 260 new community custody beds, and 100 minimum custody beds - we will need to work hard to keep our lower custody beds filled. We can't justify the cost associated with renting beds for work release.</p>	<p>With our commitment to build 260 new community custody beds, and 100 minimum custody beds - we will need to work hard to keep our lower custody beds filled. We can't justify the cost associated with renting beds for work release.</p>

<p>2016 Annual Report</p>	<p>Review the necessity and the effectiveness of all work detail contracts</p>	<p>With the huge expansion of community beds (250+), there will be ample opportunities for transition to work release. Engaging in detail work is an effective transition approach.</p>		
<p>2016 Annual Report</p>	<p>Review how inmates in community corrections are determined to be eligible for work detail versus work release in order to determine whether or not changes could be made to make more inmates eligible for work release</p>	<p>Same response.</p>		
<p>2016 Annual Report</p>	<p>Propose an increase in funding to the Vocational and Life Skills grant program</p>	<p>Not until we can show data that supports additional funding.</p>	<p>Data collection and analysis continues.</p>	<p>Still working on getting a valid assessment of the most effective approaches with VLS. UNO expects to deliver an assessment report in fy2020</p>
<p>2016 Annual Report</p>	<p>Expand the use of peer support programs by using inmates and people from outside NDCS. For example, consider using trained peers in restrictive housing settings or with individuals who turn down programming opportunities</p>	<p>We are on this path.</p>	<p>Pilot program has been launched at NSP</p>	<p>Results are promising, expansion is underway</p>

<p>2016 Annual Report</p>	<p>Reconvene the work group on travel orders and present a plan that has short-term and long-term solutions and related plans of action to the NDCS Director and the Medical Director no later than January 1, 2017</p>	<p>Dr. Deol was able to resolve the issue.</p>		
<p>2016 Annual Report</p>	<p>Work with the Inspector General to update the programming spreadsheet on a quarterly basis</p>	<p>We are close to having this ready for publication.</p>		
<p>2016 Annual Report</p>	<p>Examine the benefits of establishing new positions in medical areas, such as medication aides or medical assistants, that would then allow other health services staff to focus on their more immediate responsibilities</p>	<p>Considered, but the compensation is so low that it is difficult to attract and retain people in these positions (Veteran's homes seeing very high turnover).</p>	<p>Efforts to use the Med Aide job series were unsuccessful - could not recruit candidates at the authorized wage scale.</p>	<p>Electronic Medication Administration Record software has been implemented agency wide. These tools greatly improve the efficiency and accuracy of issuing medication.</p>
<p>2016 Annual Report</p>	<p>Work jointly with the Adult Parole Administration and the Board of Parole to present a plan to the Governor and the Legislature detailing how a correctional system overcrowding emergency would be administered</p>	<p>When the time is right</p>	<p>Report will be published by December 2018</p>	<p>Report published</p>

<p>2016 Annual Report</p>	<p>Work with peer facilities in other states to establish video conferences or other communication opportunities for staff from those facilities to interact with comparable NDCS staff. The emphasis would be on communicating with staff who have gone through changes or situations similar to what is taking place in that particular NDCS facility</p>	<p>This is happening in a variety of ways, and we will continue to build on the concept.</p>		
<p>2016 Annual Report</p>	<p>Establish a two-year pilot program in order to provide “a specialized program to provide services for individuals with a developmental disability as defined by the Division of Developmental Disabilities.” The program would require that the Department contract with a provider certified by the Division and that they track data related to the program and report it to the Governor and Legislature. An emphasis of the program would be to assist with the successful re-entry of this population into the community</p>	<p>We will have housing dedicated to cognitively impaired inmates by January, 2019, and programming to address their special needs. We will partner with HHS to develop evidence based approaches. This is an important issue, but we are not ready to focus on this project.</p>	<p>Due to competing demands this project has been extended to July 2019.</p>	<p>Addressing the needs of the cognitively impaired population remains a top priority, and funding is now available to address programming needs. With the passage of LB686 we are prioritizing this work over the next 7 months.</p>
<p>2017 Lamere Report</p>	<p>Review the ability to “turn down the volume” as it relates to response buttons</p>		<p>There are no volume controls for cell call buttons.</p>	

<p>2017 Lamere Report</p>	<p>Utilize substance abuse treatment staff to initiate a drug awareness campaign to educate inmates and staff regarding the dangers of using illegal drugs</p>		<p>A campaign was initiated in the fall of 2017. It is time to renew those efforts. New videos have been provided for facilities' closed circuit channel regarding the dangers of using K2.</p>	<p>Efforts continue</p>
<p>2017 Lamere Report</p>	<p>Increase the frequency and thoroughness of searches of staff as they enter the prisons</p>		<p>Contraband detection is a priority and efforts are on-going to ensure the safety of staff and inmates.</p>	
<p>2017 Lamere Report</p>	<p>Utilize drug dogs on a more frequent basis at the entrances of the prisons in order to act as a deterrent and to catch any illegal drugs that are being brought into the prisons</p>		<p>An additional canine position was established at OCC - resources have been and will continue to be fully utilized.</p>	<p>Adding another canine position - will be housed at NCCW, provide support to WEC, and other agency facilities as needed</p>
<p>2017 Lamere Report</p>	<p>Consider working with law enforcement agencies to assist with staff searches so that an outside entity is conducting the searches on a random basis</p>		<p>Idea considered, not adopted</p>	
<p>2017 Lamere Report</p>	<p>Review the search policy for visitors in order to determine whether or not it needs to be adjusted to conduct enhanced and appropriate searches of visitors</p>		<p>This is done on a regular basis</p>	

<p>2017 Lamere Report</p>	<p>Conduct a review of visitor and staff searches at each prison, including whether or not the searches are being done in the manner prescribed by DCS, whether they are fairly and uniformly administered, and whether the ability to conduct such searches is impacted by staffing levels</p>		<p>Review completed in the fall of 2017, on-going monitoring continues.</p>	
<p>2017 Lamere Report</p>	<p>Report any action taken on these recommendations to the OIG</p>			
<p>2017 TSCI Fire Report</p>	<p>Review all policies regarding emergency situations where it involves possible dangerous and even deadly actions by an inmate in situations such as the one that Mr. YYYYYYY was involved. Determine whether action against an individual could have been taken in this case and in future cases in which would allow such situations to be handled in a more timely and responsive manner</p>		<p>Addressed through CIR</p>	

<p>2017 TSCI Fire Report</p>	<p>Review the incident and determine whether or not Mr. YYYYYYY's cell door should have been closed sooner than it was and whether or not the showers should have been turned off earlier than they were</p>		<p>Addressed through CIR</p>	
<p>2017 TSCI Fire Report</p>	<p>Always contact the fire department and the Nebraska State Fire Marshal in the case of a fire. In this case, review why those two entities were not contacted and address this lack of appropriate action as soon as possible</p>		<p>Addressed through CIR</p>	
<p>2017 TSCI Fire Report</p>	<p>Continue to improve the Immediate Segregation and Longer-Term Restrictive Housing placement policies, including the use of active STG in placing inmates in those placements</p>		<p>On-going efforts since 2015</p>	
<p>2017 TSCI Fire Report</p>	<p>Work with NDCS Health Services to determine whether medical staff could be moved closer to the location of a serious health incident so that triaging and more timely medical care could be provided</p>		<p>reviewed, no changes</p>	

<p>2017 TSCI Fire Report</p>	<p>Review an inmate in a restraint chair every 15 minutes in order to determine whether or not he could be safely removed from it rather than placing him or her there automatically for two hours</p>		<p>Policy addresses use of the restraint chair.</p>	
<p>2017 TSCI Fire Report</p>	<p>NDCS, the Nebraska State Patrol, the Office of Inspector General for Corrections, and any other relevant parties should meet within 60 days to discuss the policy for maintaining video of serious incidents that take place at facilities operated by NDCS</p>		<p>Need was addressed through changes in practice</p>	
<p>2017 TSCI Fire Report</p>	<p>Review the Immediate Segregation and Longer-Term Restrictive Housing policies that allow for bedding and other supplies to be left in a gallery while inmates are allowed to walk through the gallery unattended</p>		<p>Addressed through CIR</p>	
<p>2017 TSCI Fire Report</p>	<p>Report all actions related to these recommendations to the OIG in a timely manner</p>			

<p>2017 Berry Report</p>	<p>Immediately suspend the practice of double bunking in restrictive housing units until the NDCS Restrictive Housing Internal and External Work Groups have had the opportunity to review the policy of double bunking in restrictive housing units and issue a recommendation regarding the policy to the Director of NDCS</p>		<p>Practice reviewed, double bunking continues to be used as appropriate.</p>	
<p>2017 Berry Report</p>	<p>Review the Restrictive Housing Assignment of Living Location worksheets that have been done since January 1, 2017 in order to determine if they were completed correctly</p>		<p>Past documents were not reviewed, additional communication with inmates was initiated to ensure compatibility issues are identified/addressed promptly.</p>	
<p>2017 Berry Report</p>	<p>Continue the efforts by NDCS to reduce the number of individuals in restrictive housing and protective management settings</p>		<p>Efforts have been underway since 2015 and continue.</p>	
<p>2017 Berry Report</p>	<p>Examine the possibility of using peer mentors to work with inmates who choose not to follow orders to move to another cell</p>		<p>Peer mentoring pilot program in progress at NSP.</p>	<p>Efforts continue, with enhanced training/certification at NSP and training started at TSCI.</p>

<p>2017 Berry Report</p>	<p>Conduct a comprehensive review that examines why Mr. Berry was located at TSCI, whether or not he received the services and programming he needed in order to successfully begin to transition into the community, and whether or not a different placement would have been more appropriate for him as a result of his crime, age, behavioral challenges and sentence length</p>		<p>CIR addressed relevant issues</p>	
<p>2017 Berry Report</p>	<p>Report any action taken on these recommendations to the OIG</p>			
<p>2017 Annual Report</p>	<p>Consider the directing of front-line recruiting efforts at staff who are employed at correctional facilities in Kansas and Missouri due to their lower rate of pay for those positions</p>		<p>Recruiting efforts reach a broad audience.</p>	
<p>2017 Annual Report</p>	<p>Study whether or not it is feasible and fruitful to provide gender specific training and ongoing supports to female staff</p>		<p>NDCS is hosting an NIC Women in Corrections training event in the fall of 2018. Other training options are being considered.</p>	<p>Follow-up training through NIC occurred in July, 2019. Efforts will continue</p>
<p>2017 Annual Report</p>	<p>Include data on vacancies identified in the 2016 staffing analysis when compiling and sharing data on staff vacancies at each facility</p>		<p>This recommendation will be considered once the staffing analysis is fully funded and implemented. Until that time, the information has no applicability.</p>	

2017 Annual Report	Conduct a full staffing analysis of NDCS		Will be complete by December 2020.	Will complete by deadline
2017 Annual Report	Present a recommendation to the Governor and the Legislature regarding the need to request retention and recruitment funding from Legislature, including a plan on how those funds would be utilized if appropriated		Our focus is on on-going staff compensation, rather than one-time funds that do not have sustainable impact.	
2017 Annual Report	Work jointly with the Office of Parole Administration and the Board of Parole to present a plan to the Governor and the Legislature by March 1, 2018 detailing how a correctional system overcrowding emergency would be administered		A plan will be completed by December 2018.	Done
2017 Annual Report	Invite members of the external restrictive housing work group to observe meetings of the internal restrictive housing work group		We will consider this recommendation once the external workgroup membership is restored (need to fill 2 of 4 positions).	Attempts to have external stakeholders sit in and observe agency work meetings has not proved effective. Positions were filled, but the Workgroup has been expanded by new legislation and additional members will need to be added

<p>2017 Annual Report</p>	<p>Determine whether or not the membership of the external restrictive housing work group needs to be adjusted, as well as whether or not the role or mission of the work group needs to be changed</p>		<p>Per statute, the purpose of the work group is broad: "the work group shall advise the department on policies and procedures related to the proper treatment and care of offenders in long-term restrictive housing." Consideration will be given to particular ways to more fully engage work group members for the most beneficial discussions and outcomes.</p>	<p>The evolution of the workgroup continues. LB686 added two more members, and recruitment is underway.</p>
<p>2017 Annual Report</p>	<p>Request an exception from the Governor's office to allow for the rules and regulations process to move forward regarding the Administrative Regulation for NDCS restrictive housing</p>		<p>No exception is needed.</p>	
<p>2017 Annual Report</p>	<p>Report all unit lock downs to the OIG in a timely manner</p>		<p>Reports of modified operations are made to the OIG.</p>	
<p>2017 Annual Report</p>	<p>Audit Immediate Segregation and Longer Term Restrictive Housing practices to determine if the regulations and procedures are being followed by staff and the administration, including the timeliness and accuracy of paper work</p>		<p>A review of RH processes will be made in coordination with upcoming revisions to the ACA standards regarding restrictive housing.</p>	

<p>2017 Annual Report</p>	<p>Review restrictive housing practices in other states to determine whether the 24 hour out-of-cell time is still appropriate or needs to be adjusted</p>	<p>Have not identified any other state that defines restrictive housing as being anything more than 24 hours out of cell time per week. Most state systems are still operating on the 23/1 or 22/2 model.</p>	
<p>2017 Annual Report</p>	<p>Assess the need for an expansion of family programs for inmates within NDCS</p>	<p>Legislation was introduced, on behalf of NDCS, to expand the use of Inmate Welfare funds for family-friendly initiatives in 2018, but did not move forward.</p>	
<p>2017 Annual Report</p>	<p>Continue to look for ways to expand peer supports throughout NDCS</p>	<p>The success of the NSP pilot project will help determine next steps.</p>	
<p>2017 Annual Report</p>	<p>Establish a work group of staff, inmates and outside interests to review the inmate job system, including a review of inmate pay rates, job classifications, and any other issues identified by the work group or NDCS</p>	<p>To fully impact the inmate work program, we will move away from the current practice of providing "employment" to every inmate in the system. This will allow for improved compensation for those who are employed and decreased waitlists for people who want jobs. This is a significant cultural change - one that I will pursue when I believe the time is right.</p>	<p>Based on statutory requirement to offer employment to all inmates, meaningful revision of the inmate employment system will require legislative changes.</p>

<p>2017 Annual Report</p>	<p>Determine whether additional re-entry specialists are needed now and in the future due to changes being made by NDCS and Parole</p>		<p>Two positions were added to Reentry in 2017. The focus remains on addressing protective service staffing, and case management capacity. With adequate staffing to oversee inmate activities/movement, and case management staff focused on preparing people for handoff to community supervision, reentry staff can focus on engagement and finding resources for those inmates that struggle to help themselves. We have not yet achieved full/effective use of existing resources.</p>	
<p>2017 Annual Report</p>	<p>Provide updates to the OIG and the LR 127 Committee regarding the medical care transition at TSCI in October 2017 and December 2017</p>		<p>The transition went well. We will continue to have challenges with filling nursing staff positions (compensation and location), requiring the use of contract nursing staff.</p>	
<p>2017 Annual Report</p>	<p>Establish a long-term plan for higher education and vocational education opportunities and present it to the Governor and the Legislature</p>		<p>Current focus is ensuring full utilization of existing resources, quality assurance, and research to show effectiveness.</p>	

<p>2017 Annual Report</p>	<p>Request that the Department of Administrative Services review the wage scale for Mental Health Practitioners, Substance Abuse treatment staff, and any other positions identified by NDCS as needing an updated and more accurate wage scale</p>		<p>Compensation reviews for positions with retention/recruitment issues will continue.</p>	
<p>2017 Annual Report</p>	<p>Work with policy makers to determine whether or not the inmate welfare fund state statute should be updated so that the funds are able to provide additional quality of life opportunities for inmates beyond what is currently in state statute</p>		<p>Legislation was introduced, on behalf of NDCS, to expand the use of Inmate Welfare funds for family-friendly initiatives in 2018, but did not move forward.</p>	
<p>2017 Annual Report</p>	<p>Review the operation of the inmate councils and determine whether or not a more formalized council should be utilized</p>		<p>The inmate councils provide a positive means of two-way communication and continue to evolve.</p>	
<p>2017 Annual Report</p>	<p>Prepare a budget request for the Governor and the Legislature that fully addresses the needs of NDCS to carry out their responsibilities, including what is needed to recruit and retain all staff, infrastructure and building needs, programming needs, and any other needs identified by NDCS</p>		<p>This is done every two years, in concert with a strategic plan.</p>	

<p>December 20, 2018 Email to Director Frakes</p>	<p>My suggestion is that the Department consider providing body cameras to staff who escort inmates outside the facilities so that if an incident takes place it can be captured on video. I believe this would be helpful for the Department.</p>	<p>We continue to gather information from the body camera project at TSCI. Body cameras are a significant investment, and the benefits for corrections are still being studied.</p>	<p>No plans to expand usage in the next biennium</p>
<p>February 2016 Letter to Director Frakes</p>	<p>“The Nebraska Department of Correctional Services should include data of the inmates assigned to the county jails in their Nebraska Inmate Case Management system. The data of those inmates should be included in the data just as it would be if they were located at a state correctional facility. In addition, I would also recommend that a separate tab be created within the system so that the data for this population can be viewed and assessed in a transparent manner.”</p>	<p>Data for all inmates committed to NDCS is in NICaMS, regardless of the person's physical location. The agency intends to continue to reduce the use of jail beds, and should be all but incidental use when the 160-bed unit comes on line at CCCL (if not before).</p>	<p>Increases in the total population numbers necessitate the ongoing use of jail beds for temporary housing. The average length of stay is under 90 days.</p>
<p>February 6, 2018 Letter to Director Frakes</p>	<p>I would recommend that the Department review options related to providing text message updates to interested people for each facility.</p>	<p>Considered, not adopted</p>	

<p>February 6, 2018 Letter to Director Frakes</p>	<p>First, reinforce with the different levels of decision makers that they need to make their recommendations based on information that they have seen and they feel is correct, as well as in the behavior of the inmate. If they feel based on their work with that person that they deserve an opportunity to transition out of LTRH then they should make that recommendation.</p>		<p>This is, and has been, the expectation.</p>	
<p>February 2018 Letter to Director Frakes</p>	<p>Second, the Behavior/Programming Plans for individuals should provide more concrete transitional information for the inmate and more effort should be made to follow the AR and have inmates actively “participate in discussions and planning of criteria and next steps for each transition opportunity” and also to have them “help craft individualized goals and areas for improvement.”</p>		<p>Getting inmates to engage in this process is an on-going challenge. We currently have a measurable part of the RH population that refuses to engage and we believe they direct others to not engage. We are making progress.</p>	<p>We are seeing noticeable progress with getting people to engage.</p>

<p>March 21, 2018 Email to Director Frakes</p>	<p>I would like to make one recommendation to the Department as a result of my review. It is my understanding that there was intelligence obtained that showed that Mr. Rogers was attempting to "use" the Ombudsman's office to move back to a correctional facility. Based on his prior history, it appears that his intent was to return to Lincoln so he could initiate new plans at escaping from a correctional facility. My recommendation is that the Department consider working with the Ombudsman's office and even my office to establish a process that would result in sharing information such as that in the future.</p>		<p>We will continue to manage intelligence/information in a manner that ensures the safety of all involved.</p>	
<p>May 29, 2018 Email to Deputy Director Rothwell</p>	<p>I would suggest that NDCS look at changing the policy on overtime as it relates to the facilitators. Right now this is causing a significant hardship at NSP and they are struggling to run classes. I think this would be an immediate change that could help with that. I would actually suggest that you consider changing that policy for facilities with staffing issues, for at least the next six months</p>		<p>Changes are underway to address this issue at all locations where staffing is impacting case management.</p>	

<p>June 13, 2018 Email to Director Frakes</p>	<p>In December I shared with you a suggestion that I had regarding the use of body cameras when staff transport inmates outside of facilities. I would like to add to that based on a number of cases that I have recently reviewed. I would actually recommend that you examine using body cameras during those transport times, during cell extractions (actually on a member of the team doing the actual extraction), and during cell searches. I think this could allow for more accountability and transparency but also more protection for staff who are accused of abuse, etc.</p>		<p>We continue to gather information from the body camera project at TSCI. Body cameras are a significant investment, and the benefits for corrections are still being studied.</p>	<p>No plans to expand usage in the next biennium</p>
<p>2018 Annual Report</p>	<p>Begin to calculate staff turnover rates in the same manner as the Nebraska Department of Administrative Services, but also continue with the current calculation method until a later date;</p>			<p>Our method provides consistent data over a number of years, and provides the information needed to guide decisions</p>
<p>2018 Annual Report</p>	<p>Review the ability of NDCS to pay an additional bonus or stipend to staff who speak and utilize a foreign language during their employment;</p>			<p>Under consideration - won't happen in 2019</p>

<p>2018 Annual Report</p>	<p>Revisit the past recommendation of presenting salary proposals to the Department of Administrative Services that would either result in longevity pay or the establishment of a tiered plan system where an employee can be rewarded for reaching certain work goals, achievements or certifications. For example, positions of Corporal I, Corporal II, and Corporal III could be created. To move from one tier to the other the individual would have to be in their position for a certain period of time, take outside classes, gain a special certification or accomplish goals established by NDCS. Health services staff could achieve something similar if they receive a form of health professional certification;</p>		<p>Compensation work for 2019 is completed.</p>
<p>2018 Annual Report</p>	<p>Revisit the past recommendation of providing additional pay for employees who participate in extra duties that require additional training;</p>		<p>Compensation work for 2019 is completed.</p>

<p>2018 Annual Report</p>	<p>Meet with the leaders of Nebraska's community college community to discuss the possibility of working with them to establish career tracks and other classes or training programs to recruit, develop and grow the NDCS work force;</p>			<p>Currently working with Doane College, and DOL - exploring potential pilot programs</p>
<p>2018 Annual Report</p>	<p>Conduct a follow-up study to the 2016 Culture Study to learn what has changed regarding the culture of NDCS, including making use of employee surveys;</p>			<p>Engagement work with Gallup will meet this need</p>
<p>2018 Annual Report</p>	<p>Provide a plan for improving and expanding core support needs to the Governor and the Legislature no later than December 1, 2018;</p>			<p>addressed through the budget process</p>
<p>2018 Annual Report</p>	<p>Provide a plan for addressing the maintenance backlog of over \$60 million in projects to the Governor and the Legislature no later than December 1, 2018;</p>			<p>addressed through the budget process</p>
<p>2018 Annual Report</p>	<p>Meet with the OIG prior to November 1, 2018 to review Neb. Rev. Stat. § 47-905 and determine if any language in the statute needs to be amended so that the OIG and NDCS have consistency and agreement in the reporting of serious injuries and deaths;</p>			<p>Current statutory language is adequate</p>

2018 Annual Report	Contact the Nebraska State Patrol whenever a staff member is assaulted in the line of duty, including any sexual contact or possible offenses;			This is the practice
2018 Annual Report	Review the numerous suggestions made by the OIG to NDCS in 2018 regarding restrictive housing practices;			done
2018 Annual Report	Review statistics related to the racial breakdown of those in restrictive housing, TCP, Protective Management, and living units that are being run under modified operations, and determine if changes need to be made in this area;			This is an issue that remains under review. If the IG identifies practices that suggest racial disparity, please inform me
2018 Annual Report	Review the operations of Intel and possibly utilize outside entities to assist with this effort, in order to determine whether changes need to be made to improve this division, so that it more closely adheres to standards of fairness.			The evolution of the division continues
2018 Annual Report	Review the success of the "Blue Room" at NCCW and determine whether or not this could be replicated at other facilities;			done

2018 Annual Report	Continue the work being done to review, improve and expand programming in all living units, including restrictive housing units;			on-going
2018 Annual Report	Create methods of tracking contraband in each facility, and in the entire correctional system;			Current methods meet agency needs
2018 Annual Report	Require the Division of Health Services to produce a report no later than January 1, 2020 that conducts a complete assessment of their present situation, as well as future needs and challenges;			assessment is on-going
2018 Annual Report	Support the work of the NDCS Suicide Work Group;			on-going
2018 Annual Report	Continue reviews of the effectiveness and accuracy of the classification tool;			on-going
2018 Annual Report	Request the National Institute of Corrections to visit Nebraska and assess security at DEC, LCC and NSP, as well as provide security audit training for staff at those facilities;			Internal audit process is adequate
2018 Annual Report	Issue a Request for Proposal for the risk and needs tool that is currently being provided by Vant4ge this fall;			Will remain with current RNR tool

<p>2018 Annual Report</p>	<p>Provide overtime pay for facilitators of non-clinical programs in facilities that currently have understaffing issues and consider hiring of staff on a temporary basis to run non-clinical programs in understaffed facilities;</p>			<p>Not sustainable, will not contribute to needed culture change</p>
<p>2018 Annual Report</p>	<p>Review the need for razor wire around the fence at WEC;</p>			<p>done</p>
<p>2018 Annual Report</p>	<p>Consider reviving the plan for a qualitative analysis of clinical programming;</p>			<p>done</p>
<p>2018 Annual Report</p>	<p>Provide secure opportunities for inmates at the community corrections centers to apply for jobs using the internet;</p>			<p>done</p>
<p>2018 Annual Report</p>	<p>Assess the quality of the mental health treatment provided in community corrections centers in order to determine whether changes need to be made in the providing that care;</p>			<p>done</p>
<p>2018 Annual Report</p>	<p>Conduct exit interviews of inmates who are released from community corrections centers;</p>			<p>Will pilot in 2019 at CCCL female unit - start by 10/15/2019</p>
<p>2018 Annual Report</p>	<p>Review the innovative changes being made at LCC and other facilities to determine whether they can be expanded to other facilities; and</p>			<p>Part of the on-going process within the agency</p>

<p>2018 Annual Report</p>	<p>Establish a long-term plan to fund the renovation and right-sizing of the current correctional facilities and present it to the Governor and the Legislature by October 1, 2019;</p>			<p>2014 Master Plan provides adequate guidance. Funding requests to support the agency's strategic plan will be made through the established budget process</p>
--	---	--	--	---